

optibelt



Power Transmission



Metall
Metal

TEUERUNGSZUSCHLAG
PRICE INCREASE
+ 8%
Metall / Metal
gültig ab effective from 01. 09. 2004

Preisliste
Price List



Inhaltsverzeichnis *Contents*

Seite Page

optibelt TB	Taper-Buchsen <i>Taper bushes</i>	3
	Ausführungen der optibelt K5 Keilrillenscheiben, Auswuchten, Aufschläge für Fertigbohrungen <i>Types of optibelt K5 V-grooved pulleys, balancing, surcharges for finished bores</i>	4
optibelt K5	Keilrillenscheiben für Taper-Buchsen – Rillen nach DIN 2211 <i>V-grooved pulleys for taper bushes – grooves to ISO/BS/DIN</i>	5-12
optibelt K5	Keilrillenscheiben für zylindrische Bohrung – Rillen nach DIN 2211 <i>V-grooved pulleys for plain boring – grooves to ISO/BS/DIN</i>	13-18
optibelt RE	Regelscheiben <i>Variable speed pulleys</i>	19-21
optibelt RBS	Keilrippenscheiben für Taper-Buchsen <i>Ribbed belt pulleys for taper bushes</i>	22-26
optibelt RBS	Keilrippenscheiben für zylindrische Bohrung <i>Ribbed belt pulleys for plain boring</i>	26
optibelt F5	Flachriemenscheiben für Taper-Buchsen <i>Flat belt pulleys for taper bushes</i>	27
optibelt MS	Motorspansschieben <i>Motor slide rails</i>	28
optibelt MS	Motorspansschlitten <i>Motor slide bases</i>	29
optibelt ZRS	Standard-Zahnscheiben für zylindrische Bohrung <i>Timing belt pulleys for plain boring</i>	30-35
optibelt ZRS	Standard-Zahnscheiben für Taper-Buchsen <i>Timing belt pulleys for taper bushes</i>	36-41
optibelt ZRS	HTD®-Zahnscheiben für zylindrische Bohrung <i>HTD® pulleys for plain boring</i>	42-49
optibelt ZRS	HTD®-Zahnscheiben für Taper-Buchsen <i>HTD® pulleys for taper bushes</i>	50-55
optibelt ZRS	Metrische Zahnscheiben für zylindrische Bohrung, T-Type <i>Metric timing belt pulleys for plain boring, T sections</i>	56-60
optibelt ZRS	Metrische Zahnscheiben für zylindrische Bohrung, AT-Type <i>Metric timing belt pulleys for plain boring, AT sections</i>	61-64
optibelt ZRW	Standard-Zahnwellen <i>Timing bars – standard timing belts</i>	65-66
optibelt ZRW	Metrische Zahnwellen <i>Timing bars – metric timing belts</i>	67-68
optibelt TN	Tapernaben <i>Taper hubs</i>	69
optibelt TN	Zwischenhülsen <i>Adapters</i>	70
optibelt CE	Spannelemente <i>Clamping bushes</i>	71-86

Die Preise dieser Liste stellen keine Preisempfehlung für den Weiterverkauf dar. **Versandkosten zu Lasten des Empfängers.** Bezüglich der Haftung und Lieferung verweisen wir auf unsere allgemeinen Geschäftsbedingungen. Mit Erscheinen dieser Liste verlieren alle früheren Preislisten ihre Gültigkeit, dies gilt auch für vorhergehende Auflagen. Änderungen auf Grund technischer Neuerungen sowie Irrtum vorbehalten. Nachdruck verboten. Zuwiderhandlungen werden urheberrechtlich verfolgt.

The prices in this list are not for resale use. Freight charges are the responsibility of the customer. Refer to our "General Conditions of Sale" for matters concerning liability and delivery. With the introduction of this list all other price lists are superceded. Alterations due to error or to technical improvements are excepted. Reprinting or photocopying forbidden. Violations of copyright will be prosecuted.

Taper-Buchsen mit metrischer Bohrung, Nut nach DIN 6885 Teil 1 Taper bushes with metric bores. Keyways to DIN 6885 Part 1																
	Taper-Buchse Taper bush															Material: EN-GJL 200 – DIN EN 1561
	1008	1108	1210	1215	1310	1610	1615	2012	2517	3020	3030	3525	3535	4040	4545	5050
Bohrungs- durch- messer Bore diameter d ₂ (mm)	10	10	11	11	14	14	14	14	16	25	35	35	35	40	55	70
	11	11	12	12	16	16	16	16	18	28	38	38	38	42	60	75
	12	12	14	14	18	18	18	18	19	30	40	40	40	45	65	80
	14	14	16	16	19	19	19	19	20	32	42	42	42	48	70	85
	16	16	18	18	20	20	20	20	22	35	45	45	45	50	75	90
	18	18	19	19	22	22	22	22	24	38	48	48	48	55	80	95
	19	19	20	20	24	24	24	24	25	40	50	50	50	60	85	100
	20	20	22	22	25	25	25	25	28	42	55	55	55	65	90	105
	22	22	24	24	28	28	28	28	30	45	60	60	60	70	95	110
	24▲	24	25	25	30	30	30	30	32	48	65	65	65	75	100	115
	25▲	25	28	28	32	32	32	32	35	50	70	70	70	80	105	120
	28▲	30	30	35	35	35	35	38	55	75	75	75	85	110	125	
		32	32		38	38	38	40	60	80	80	80	90			
					40	40	40	42	65	85	85	85	95			
					42▲	42▲	42	45	70	90	90	90	100			
								45	48							
								48	50							
								50	55							
								60	60							
Anzug Tighten- ing torque (N _m)	5,7	5,7	20	20	20	20	20	31	49	92	92	115	115	172	195	275
Buchsenlänge Bush length (mm)	22,3	22,3	25,4	38,1	25,4	25,4	38,1	31,8	44,5	50,8	76,2	63,5	88,9	101,6	114,3	127,0
Gewicht bei Weight at d _{2 min} (= Kg)	0,12	0,16	0,28	0,39	0,32	0,41	0,60	0,75	1,06	2,50	3,75	3,90	5,13	7,68	12,70	15,17
€ Stück each	6,10	7,00	9,20	11,50	11,70	11,00	11,50	13,50	16,90	22,00	28,80	58,50	55,50	78,00	99,30	159,00

▲ Diese Bohrung ist mit Flachnut ausgeführt. These bores have shallow keyways.

Flachnute für Taper-Buchsen Shallow keyways for taper bushes

Bohrungsdurchm. Bore diameter d ₂ (mm)	Nutbreite Keyway width b (mm)	Nuttiefe Keyway depth t ₂ (mm)	Bohrungsdurchm. Bore diameter d ₂ (mm)	Nutbreite Keyway width b (mm)	Nuttiefe Keyway depth t ₂ (mm)
24	8	2,0	28	8	2,0
25	8	1,3	42	12	2,2

Taper-Buchsen mit Zoll-Bohrung, Nut nach Britischem Standard BS 46 Teil 1 Taper bushes with inch bores. Keyways to BS 46 Part 1																	
	Taper-Buchse Taper bush															Material: EN-GJL 200 – DIN EN 1561	
	1008	1108	1210	1215	1310	1610	1615	2012	2517	3020	3030	3525	3535	4040	4545	5050	
Bohrungs- durch- messer Bore diameter d ₂ (Zoll inch)	3/8*	3/8*	1/2	5/8*	1/2*	1/2	1/2	5/8*	3/4	1 1/4	1 1/4	1 1/2*	1 1/2	1 3/4*	2 1/4*	3*	
	1/2	1/2	5/8	3/4	5/8*	5/8	5/8	3/4	7/8	1 3/8	1 3/8	1 5/8*	1 5/8	1 7/8*	2 3/8*	3 1/4*	
	5/8	5/8	3/4	7/8	3/4*	3/4	3/4	7/8	1	1 1/2	1 1/2	1 3/4*	1 3/4	2*	2 1/2*	3 1/2*	
	3/4	3/4	7/8	1	7/8*	7/8	7/8	1	1 1/8	1 5/8	1 5/8	1 7/8*	1 7/8	2 1/8*	2 3/4*	3 3/4*	
	7/8*	7/8	1	1 1/8	1*	1	1	1 1/8	1 1/4	1 3/4*	1 3/4*	2*	2	2 1/4*	2 7/8*	4*	
	1▲	1	1 1/8	1 1/4	1 1/8	1 1/8	1 1/8	1 1/4	1 3/8	1 7/8	1 7/8	2 1/8*	2 1/8	2 3/8*	3*	4 1/4*	
		1 1/8▲*	1 1/4		1 1/4	1 1/4	1 1/4	1 3/8	1 1/2	1 5/8	2	2 1/4*	2 1/4	2 1/2*	3 1/4*	4 1/2*	
					1 3/8	1 3/8	1 3/8	1 1/2	1 5/8	1 3/4	2 1/8*	2 1/8*	2 3/8*	2 3/8	2 5/8*	3 3/8*	4 3/4*
						1 1/2	1 1/2	1 5/8	1 3/4	1 7/8	2 3/8	2 3/8	2 5/8*	2 5/8	2 7/8*	3 3/4*	5*▲
							1 5/8	1 5/8▲*	1 3/4	1 7/8	2 3/8	2 3/8	2 5/8*	2 5/8	2 7/8*	3 3/4*	
									1 7/8	2	2 1/2	2 1/2	2 3/4*	2 3/4	3*	4*	
								2	2 1/8	2 5/8	2 5/8*	2 7/8*	2 7/8	3 1/8*	4 1/4*▲		
									2 1/4	2 3/4	2 3/4*	3*	3	3 1/4*	4 1/2*▲		
									2 3/8	2 7/8	2 7/8	3 1/8*	3 1/8	3 3/8*			
									2 1/2	3	3	3 1/4*	3 1/4	3 1/2*			
												3 3/8*	3 3/8	3 3/4*▲			
												3 1/2*▲	3 1/2▲	4*▲			
Anzug Tighten- ing torque (N _m)	5,7	5,7	20	20	20	20	20	31	49	92	92	115	115	172	195	275	
Buchsenlänge Bush length (mm)	22,3	22,3	25,4	38,1	25,4	25,4	38,1	31,8	44,5	50,8	76,2	63,5	88,9	101,6	114,3	127,0	
Gewicht bei Weight at d _{2 min} (= Kg)	0,12	0,16	0,28	0,39	0,32	0,41	0,60	0,75	1,06	2,50	3,75	3,90	5,13	7,68	12,70	15,17	
€ Stück each	6,10	7,00	9,20	11,50	11,70	11,00	11,50	13,50	16,90	22,00	28,80	58,50	55,50	78,00	99,30	159,00	

* Keine Lagerware Non stock items ▲ Diese Bohrung ist mit Flachnut ausgeführt. These bores have shallow keyways.

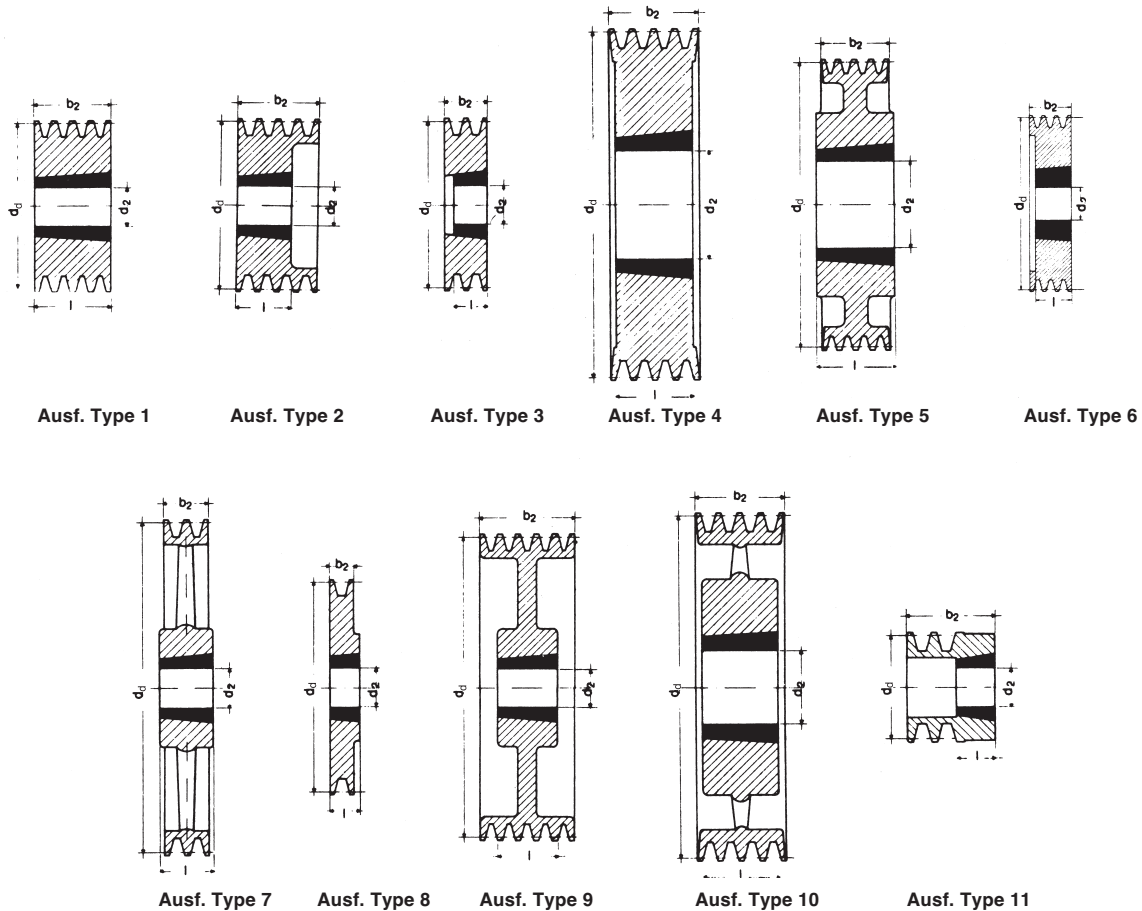

Fertigungstechnische Änderungen der Ausführungen vorbehalten.
 We reserve the right to make technical changes.

Auswuchten

Die Listenpreise gelten für in einer Ebene nach DIN/ISO 1940 ausgewuchtete GG-Scheiben wie folgt:
 Gütestufe G 6,3 für $\varnothing d_d \leq 400$ mm bei $n = 1500 \text{ min}^{-1}$, für $\varnothing d_d > 400$ mm bei $v = 30 \text{ m/s}$.

Die Auswuchtung wird ohne Nut auf glattem Wuchtdorn vorgenommen. Für Maschinen, deren Läufer mit einer in das Wellenende eingesetzten vollen Passfeder ausgewuchtet sind, muss mit folgendem Vermerk bestellt werden:
 »Ausgewuchtet mit Fertigbohrung und leerer Nut auf glattem Wuchtdorn ohne eingesetzte Passfeder«.

Ein Auswuchten in zwei Ebenen Gütestufe G 6,3 oder feiner ist erforderlich, wenn $v \geq 30 \text{ m/s}$ oder das Verhältnis Richtdurchmesser zu Kranzbreite $d_d : b_d < 4$ ist bei $v > 20 \text{ m/s}$.

Mehrpreis auf Anfrage nach Bekanntgabe der Betriebsdrehzahl.

Balancing

The list prices apply, as per VDI 2060, to cast iron pulleys balanced in one plane as follows:
 Grade G 6.3 for $\varnothing d_d \leq 400$ mm at $n = 1500 \text{ rpm}$, for $\varnothing d_d > 400$ mm at $v = 30 \text{ m/sec}$.

Balancing is carried out minus the key on a smooth mandrel. Machines where the rotors are balanced with an adjusting spring inserted in the shaft end must be ordered as follows: "Balanced with finished bore without key on a smooth mandrel without inserted spring".

We recommend balancing in two planes grade G 6.3 or better if $v \geq 30 \text{ m/sec}$. or if the ratio between datum diameter and pulley face width $d_d : b_d < 4$ at $v > 20 \text{ m/sec}$.

Surcharges for balancing on request. Please give pulley operating speed.

**Aufschläge für Fertigbohrung H7 und Passfedernut nach DIN 6885 Teil 1
 Surcharges for finished bore H7 and keyway to DIN 6885 part 1**

Stück Quantity	Fertigbohrung bis 30 mm Finished bore up to 30 mm		Fertigbohrung 31 bis 50 mm Finished bore 31 to 50 mm		Fertigbohrung 51 bis 75 mm Finished bore 51 to 75 mm		Gewindebohrung für Stellschraube Drilled and tapped for setscrews €/Stück each
	ohne Nut without keyway	mit Nut with keyway	ohne Nut without keyway	mit Nut with keyway	ohne Nut without keyway	mit Nut with keyway	
	€/Stück each	€/Stück each	€/Stück each	€/Stück each	€/Stück each	€/Stück each	
1 bis to 2	56,40	70,60	81,00	98,40	101,00	127,00	28,50
3 bis to 5	48,70	61,30	69,80	85,10	87,30	109,00	23,20
6 bis to 10	41,80	53,10	61,00	73,60	75,80	95,20	19,70
11 bis to 24	39,20	49,50	56,40	68,70	70,30	88,40	17,60
25 bis to 50	35,50	45,40	52,00	62,60	64,50	81,00	15,80
über over 50	33,40	41,80	48,20	58,30	59,90	75,50	14,80

Sonderbearbeitungen und Sonderscheiben auf Anfrage. Special pulleys and custom designed pulleys on request.

Profil Section SPZ/10

Richt-durchmesser Datum diameter d_2 (mm)	Anzahl der Rillen No. of grooves	Ausführung Type		Gewicht ohne Buchse Weight without bush (= kg)	Taper-Buchse Taper bush	€ Stück ohne Buchse each without bush	Richt-durchmesser Datum diameter d_2 (mm)	Anzahl der Rillen No. of grooves	Ausführung Type		Gewicht ohne Buchse Weight without bush (= kg)	Taper-Buchse Taper bush	€ Stück ohne Buchse each without bush	
50▲	1	●	11	0,3	1008	18,90	118	1	●	8	0,9	1610	24,80	
	2	●	11	0,4	1008	23,00		2	●	6	1,3	1610	27,60	
56▲	1	●	11	0,4	1008	15,10		3	●	6	1,6	2012	34,50	
	2	●	11	0,5	1108	17,30		4	●	6	1,8	2012	39,00	
60	1	●	8	0,2	1008	15,50		5	●	6	1,8	2012	48,60	
	2	●	11	0,6	1108	18,10		6*	●	6	2,0	2517	51,40	
63	1	●	8	0,2	1108	16,20		125	1	●	8	1,0	1610	26,40
	2	●	6	0,3	1108	18,90			2	●	6	1,4	1610	28,80
	3	●	6	0,4	1108	24,20			3	●	2	1,8	2012	35,40
67	1	●	8	0,3	1108	16,30			4	●	2	2,2	2012	42,10
	2	●	6	0,4	1108	19,70			5	●	6	2,3	2012	49,40
	3	●	6	0,5	1108	24,80			6*	●	6	2,5	2517	53,70
71	1	●	8	0,3	1108	16,50	132	1	●	8	1,1	1610	27,60	
	2	●	6	0,4	1108	20,10		2	●	6	1,5	1610	29,20	
	3	●	6	0,6	1108	25,40		3	●	2	2,3	2012	36,50	
	75	1	●	8	0,4	1108		17,10	4	●	2	2,5	2012	43,20
2		●	6	0,4	1210	20,30	5	●	6	2,7	2517	50,20		
3		●	6	0,5	1210	25,80	6*	●	6	2,9	2517	55,60		
80	1	●	8	0,5	1210	17,30	140	1	●	8	1,2	1610	28,40	
	2	●	6	0,6	1210	21,00		2	●	2	1,7	1610	31,70	
	3	●	6	0,7	1210	26,40		3	●	2	2,6	2012	38,60	
	4	●	6	0,8	1210	27,80		4	●	2	2,9	2012	44,40	
	85	1	●	8	0,6	1210		17,70	5	●	2	3,2	2517	51,80
2		●	6	0,5	1610	21,10	6*	●	2	3,5	2517	57,60		
3		●	6	0,6	1610	27,00	8*	●	4	4,0	2517	105,00		
4		●	6	0,9	1610	32,90	150	1	●	8	1,2	1610	29,90	
5		●	6	1,0	1610	39,30		2	●	8	2,0	2012	33,30	
90	1	●	8	0,7	1210	18,10		3	●	2	3,1	2012	40,50	
	2	●	6	0,7	1610	21,70		4	●	2	3,7	2517	47,10	
	3	●	6	0,8	1610	27,60		5	●	2	4,0	2517	54,00	
	4	●	6	1,0	1610	34,80	6*	●	2	4,4	2517	58,30		
	5	●	6	1,2	1610	39,70	8*	●	4	5,1	2517	109,00		
95	1	●	8	0,7	1210	20,10	160	1	●	8	1,3	1610	31,80	
	2	●	6	0,8	1610	22,20		2	●	8	2,5	2012	35,10	
	3	●	6	0,9	1610	27,90		3	●	2	3,6	2012	42,10	
	4	●	6	1,1	1610	35,60		4	●	2	4,4	2517	48,30	
	5	●	6	1,3	1610	40,50		5	●	2	4,8	2517	56,80	
100	1	●	8	0,8	1210	21,10	6*	●	2	5,2	2517	63,00		
	2	●	6	0,9	1610	23,80	8*	●	4	5,6	2517	119,00		
	3	●	6	1,1	1610	29,40	170	1	●	8	1,5	1610	34,20	
	4	●	6	1,1	1610	36,10		2	●	8	2,5	2012	40,10	
	5	●	6	1,3	2012	42,40		3	○	9	4,2	2012	47,10	
	6*	●	6	1,4	2012	44,00		4	●	2	5,3	2517	54,90	
106	1	●	8	0,9	1610	21,50		5	●	2	5,9	2517	80,10	
	2	●	6	1,1	1610	25,40		6*	●	2	6,5	2517	93,70	
	3	●	6	1,3	1610	30,60	180	1	●	8	1,6	1610	34,80	
	4	●	6	1,3	1610	37,50		2	●	8	2,5	2012	41,20	
	5	●	6	1,5	2012	44,00		3	○	9	4,8	2012	47,80	
	6*	●	6	1,6	2012	47,50		4	○	9	6,1	2517	55,60	
112	1	●	8	1,0	1610	23,30		5	○	9	6,3	2517	60,40	
	2	●	6	1,3	1610	26,40		6*	○	9	6,8	2517	67,70	
	3	●	6	1,3	2012	31,70	8*	●	4	7,1	3020	125,00		
	4	●	6	1,5	2012	38,10	190	1	●	8	1,8	1610	36,60	
	5	●	6	1,8	2012	46,70		2	●	8	2,6	2012	44,40	
	6*	●	6	1,9	2012	49,40		3	○	9	4,9	2012	48,30	
▲ nur für Profil 10 only for section 10								4	○	9	5,3	2517	56,80	
								5	○	9	6,3	2517	85,20	
								6*	○	9	6,9	2517	100,00	

Anzahl der Rillen No. of grooves z	1	2	3	4	5	6	8
Kranzbreite Face width b_2 (mm)	16	28	40	52	64	76	100
Taper-Buchse Taper bush	1008	1108	1210	1610	2012	2517	3020
Bohrung d_2 (mm) von ... bis ... Bore d_2 (mm) from ... to ...	10-25	10-28	11-32	14-42	14-50	16-60	25-75
€/Stück each	6,10	7,00	9,20	11,00	13,50	16,90	22,00

- Vollscheibe Solid pulley
 - Bodenscheibe Plate pulley (mit oder ohne Spiegel with or without holes)
 - × Armscheibe Spoked pulley
- Material: EN-GJL 200 – DIN EN 1561
 * Keine Lagerware Non stock items

Bohrungsdurchmesser d_2 siehe Seite 3.
 Bore diameters d_2 see page 3.

Profil Section SPZ/10

Richt- durchmesser Datum d ₂ (mm)	Anzahl der Rillen No. of grooves	Ausführung Type		Gewicht ohne Buchse Weight without bush (= kg)	Taper- Buchse Taper bush	€ Stück ohne Buchse each without bush	Richt- durchmesser Datum d ₂ (mm)	Anzahl der Rillen No. of grooves	Ausführung Type		Gewicht ohne Buchse Weight without bush (= kg)	Taper- Buchse Taper bush	€ Stück ohne Buchse each without bush	
		●	○						x					
200	1	●	8	2,3	2012	37,90	500	2	x	7	9,1	2517	213,00	
	2	●	8	2,8	2012	46,30		3	x	7	11,4	2517	244,00	
	3	○	9	3,5	2012	49,00		4	x	10	14,3	3020	278,00	
	4	○	9	4,7	2517	57,60		5	x	10	17,6	3020	292,00	
	5	○	9	5,5	2517	65,00		6*	x	10	19,9	3020	380,00	
	6*	○	9	6,1	2517	72,30		630	3*	x	7	15,9	2517	363,00
	8*	●	4	9,3	3020	138,00			4*	x	10	20,0	3020	423,00
									5*	x	10	22,7	3020	449,00
224	1	○	5	2,5	2012	44,40		6*	x	7	33,6	3535	509,00	
	2	○	5	3,2	2012	51,80								
	3	○	9	3,9	2012	60,40								
	4	○	9	5,2	2517	71,20								
	5	○	9	6,0	2517	81,80								
	6*	○	9	6,6	2517	91,10								
	8*	●	4	11,8	3020	141,00								
	250	1	x	7	2,8	2012	49,00							
2		x	7	3,5	2012	58,30								
3		x	10	4,3	2012	69,70								
4		x	10	5,7	2517	84,90								
5		x	10	6,4	2517	98,80								
6*		x	10	7,0	2517	102,00								
8*		x	10	10,5	3020	161,00								
280		1	x	7	2,9	2012	62,30							
	2	x	7	4,0	2012	69,70								
	3	x	7	5,3	2517	79,70								
	4	x	10	6,4	2517	98,80								
	5	x	10	7,1	2517	117,00								
	6*	x	10	7,8	2517	121,00								
	8*	x	10	10,8	3020	188,00								
	315	1	x	7	3,1	2012	72,00							
2		x	7	4,2	2012	79,40								
3		x	7	6,1	2517	93,00								
4		x	10	7,6	2517	113,00								
5		x	10	8,6	2517	135,00								
6*		x	10	9,3	2517	209,00								
355	1	x	7	3,5	2012	105,00								
	2	x	7	5,1	2012	118,00								
	3	x	7	7,3	2517	149,00								
	4	x	10	8,9	2517	194,00								
	5	x	10	10,0	2517	219,00								
	6*	x	10	10,7	2517	287,00								
	8*	x	10	16,0	3030	414,00								
	400	1	x	7	6,0	2012	121,00							
2		x	7	6,3	2517	149,00								
3		x	7	8,0	2517	181,00								
4		x	10	10,1	2517	225,00								
5		x	10	11,7	3020	241,00								
6*		x	10	14,5	3020	336,00								
8*		x	10	18,2	3030	449,00								
450		1	x	7	6,1	2517	168,00							
	2	x	7	8,2	2517	194,00								
	3	x	7	9,8	2517	211,00								
	4	x	10	11,8	3020	243,00								
	5	x	10	13,9	3020	266,00								
	6*	x	10	16,9	3030	376,00								
	8*	x	10	24,0	3535	492,00								

Anzahl der Rillen No. of grooves z	1	2	3	4	5	6	8
Kranzbreite Face width b ₂ (mm)	16	28	40	52	64	76	100

Taper-Buchse Taper bush	2012	2517	3020	3030	3535
Bohrung d ₂ (mm) von ... bis ... Bore d ₂ (mm) from ... to ...	14-50	16-60	25-75	35-75	35-90
€/Stück each	13,50	16,90	22,00	28,80	55,50

- Vollscheibe Solid pulley
 - Bodenscheibe Plate pulley
(mit oder ohne Spiegel with or without holes)
 - × Armscheibe Spoked pulley
- Material: EN-GJL 200 – DIN EN 1561
 * Keine Lagerware Non stock items

Bohrungsdurchmesser d₂ siehe Seite 3.
 Bore diameters d₂ see page 3.

Profil Section SPA/13

Richt- durchmesser Datum d ₂ (mm)	Anzahl der Rillen No. of grooves	Ausführung Type		Gewicht ohne Buchse Weight without bush (= kg)	Taper- Buchse Taper bush	€ Stück ohne Buchse each without bush	Richt- durchmesser Datum d ₂ (mm)	Anzahl der Rillen No. of grooves	Ausführung Type		Gewicht ohne Buchse Weight without bush (= kg)	Taper- Buchse Taper bush	€ Stück ohne Buchse each without bush	
63▲	1	●	11	0,6	1108	22,40	140	1	●	8	1,8	1610	33,10	
	2	●	11	0,8	1108	23,80		2	●	2	2,0	2012	36,10	
67▲	1	●	8	0,3	1108	19,40		3	●	2	2,8	2517	44,40	
	2	●	6	0,5	1108	21,10		4	●	2	3,1	2517	51,80	
71▲	1	●	8	0,3	1108	19,90	150	5	●	2	3,4	2517	60,40	
	2	●	6	0,5	1108	21,90		1	●	8	1,4	1610	34,50	
	3	●	6	0,7	1108	27,40		2	●	2	2,4	2012	38,10	
75▲	1	●	8	0,4	1108	20,30		3	●	2	3,5	2517	47,10	
	2	●	6	0,6	1108	23,30		4	●	2	3,8	2517	53,70	
	3	●	6	0,8	1108	38,20		5	●	2	4,2	2517	61,10	
80▲	1	●	8	0,5	1210	20,30	160	1	○	5	1,9	1610	35,40	
	2	●	6	0,6	1210	23,00		2	●	2	2,9	2012	39,00	
	3	●	6	0,9	1210	29,40		3	●	2	3,9	2517	48,30	
85	1	●	8	0,6	1210	20,80		4	●	2	4,4	2517	55,60	
	2	●	6	0,7	1210	24,20		5	●	2	5,1	2517	63,80	
	3	●	6	1,0	1210	30,60		170	1	○	5	2,0	1610	42,10
90	1	●	8	0,7	1210	21,50	2		●	2	3,1	2012	52,90	
	2	●	6	0,7	1610	24,50	3		●	2	4,6	2517	63,50	
	3	●	6	1,0	1610	31,70	4	●	2	5,5	2517	72,30		
95	4	●	6	1,2	1615	38,10		5	●	2	5,9	3020	79,70	
	1	●	8	0,8	1210	22,80		180	1	○	5	2,1	1610	39,00
	2	●	6	0,9	1610	25,80			2	○	9	3,4	2012	45,20
	3	●	6	1,1	1610	33,30			3	●	2	5,1	2517	52,50
4	●	6	1,4	1615	38,60	4	●		2	5,9	2517	59,50		
100	1	●	8	0,8	1610	24,00		5	●	2	6,2	3020	69,20	
	2	●	6	0,9	1610	27,60		190	1	○	5	2,3	1610	52,90
	3	●	2	1,2	1610	34,50			2	○	9	3,8	2012	64,20
	4	●	2	1,7	1610	42,10			3	●	2	5,4	2517	75,40
	5	●	6	1,9	1610	49,40			4	●	2	6,8	2517	87,10
106	1	●	8	0,9	1610	25,60			5	●	2	7,4	3020	95,70
	2	●	6	1,1	1610	28,80		200	1	○	5	2,6	2012	43,20
	3	●	2	1,4	1610	36,10			2	○	5	4,1	2517	50,20
	4	●	6	2,0	2012	42,80			3	○	9	4,9	2517	56,80
	5	●	6	2,0	2012	50,90			4	●	2	7,4	3020	63,50
112	1	●	8	1,0	1610	27,00			5	●	4	8,4	3020	73,50
	2	●	6	1,2	1610	30,60		212	1	○	5	2,7	2012	47,80
	3	●	6	1,3	2012	37,50			2	○	5	4,3	2517	54,50
	4	●	6	1,9	2012	44,00			3	○	9	5,2	2517	62,30
	5	●	6	2,1	2012	53,30			4	●	2	7,3	3020	72,80
118	1	●	8	1,2	1610	28,40			5	●	2	8,2	3020	83,30
	2	●	6	1,4	1610	31,70		224	1	x	7	2,7	2012	52,10
	3	●	2	1,8	2012	38,60			2	○	5	4,4	2517	58,30
	4	●	2	2,0	2012	46,30			3	○	9	5,5	2517	67,30
	5	●	2	2,4	2012	55,60			4	●	2	7,4	3020	81,80
125	1	●	8	1,4	1610	29,90			5	●	2	8,3	3020	93,00
	2	●	2	1,7	1610	33,30		236	1	x	7	2,8	2012	56,10
	3	●	2	2,0	2012	40,50			2	○	5	4,6	2517	64,20
	4	●	2	2,5	2012	47,80			3	○	9	5,7	2517	74,70
	5	●	2	2,7	2012	56,80			4	●	2	7,8	3020	90,20
132	1	●	8	1,6	1610	31,00			5	●	2	8,7	3020	103,00
	2	●	2	1,8	2012	35,10		250	1	x	7	2,9	2012	58,30
	3	●	2	2,3	2012	42,10			2	x	7	4,8	2517	67,30
	4	●	2	2,6	2517	49,00			3	○	9	5,9	2517	79,40
	5	●	2	2,9	2517	57,60			4	○	9	8,0	3020	96,80

▲ nur für Profil 13 only for section 13

Anzahl der Rillen No. of grooves z	1	2	3	4	5
Kranzbreite Face width b ₂ (mm)	20	35	50	65	80

Taper-Buchse Taper bush	1108	1210	1610	1615	2012	2517	3020	3535
Bohrung d ₂ (mm) von ... bis ... Bore d ₂ (mm) from ... to ...	10-28	11-32	14-42	14-42	14-50	16-60	25-75	35-90
€/Stück each	7,00	9,20	11,00	11,50	13,50	16,90	22,00	55,50

- Vollscheibe Solid pulley
 - Bodenscheibe Plate pulley
(mit oder ohne Spiegel with or without holes)
 - × Armscheibe Spoked pulley
- Material: EN-GJL 200 – DIN EN 1561

Bohrungsdurchmesser d₂ siehe Seite 3.
Bore diameters d₂ see page 3.

Profil Section SPA/13

Richt- durchmesser Datum d ₂ (mm)	Anzahl der Rillen No. of grooves	Ausführung Type		Gewicht ohne Buchse Weight without bush (= kg)	Taper- Buchse Taper bush	€ Stück ohne Buchse each without bush	Richt- durchmesser Datum d ₂ (mm)	Anzahl der Rillen No. of grooves	Ausführung Type		Gewicht ohne Buchse Weight without bush (= kg)	Taper- Buchse Taper bush	€ Stück ohne Buchse each without bush
280	1	x	7	3,3	2012	72,00	450	1	x	7	7,0	2012	132,00
	2	x	7	5,4	2517	79,70		2	x	7	10,3	2517	152,00
	3	O	9	6,7	2517	92,20		3	x	7	14,1	3020	188,00
	4	O	9	8,8	3020	113,00		4	x	10	15,5	3020	223,00
	5	O	5	15,5	3535	132,00		5	x	7	24,3	3535	270,00
315	1	x	7	3,6	2012	82,50	500	1	x	7	8,0	2517	147,00
	2	x	7	6,0	2517	90,20		2	x	7	11,6	2517	166,00
	3	O	5	8,3	3020	107,00		3	x	7	16,0	3020	219,00
	4	O	9	9,7	3020	131,00		4	x	10	18,2	3020	254,00
	5	O	5	17,0	3535	153,00		5	x	7	27,3	3535	309,00
355	1	x	7	4,2	2012	97,60	560	1	x	7	11,6	2517	177,00
	2	x	7	6,7	2517	108,00		2	x	7	15,5	3020	219,00
	3	x	7	9,2	3020	131,00		3	x	7	17,8	3020	246,00
	4	x	10	11,0	3020	157,00		4	x	7	26,7	3535	288,00
	5	x	7	18,6	3535	184,00		5	x	7	30,4	3535	350,00
400	1	x	7	4,9	2012	116,00	630	1	x	7	10,1	2517	175,00
	2	x	7	8,1	2517	127,00		2	x	7	16,0	3020	263,00
	3	x	7	11,0	3020	158,00		3	x	7	22,0	3020	280,00
	4	x	10	12,8	3020	186,00		4	x	7	30,8	3535	336,00
	5	x	7	21,0	3535	221,00		5	x	7	33,7	3535	429,00

Anzahl der Rillen No. of grooves z	1	2	3	4	5
Kranzbreite Face width b ₂ (mm)	20	35	50	65	80

Taper-Buchse Taper bush	2012	2517	3020	3535
Bohrung d ₂ (mm) von ... bis ... Bore d ₂ (mm) from ... to ...	14-50	16-60	25-75	35-90
€/Stück each	13,50	16,90	22,00	55,50

- Vollscheibe Solid pulley
 - O Bodenscheibe Plate pulley
(mit oder ohne Spiegel with or without holes)
 - × Armscheibe Spoked pulley
- Material: EN-GJL 200 – DIN EN 1561

Bohrungsdurchmesser d₂ siehe Seite 3.
 Bore diameters d₂ see page 3.

Profil Section SPB/17

Richt-durchmesser Datum diameter d_2 (mm)	Anzahl der Rillen No. of grooves	Ausführung Type		Gewicht ohne Buchse Weight without bush (= kg)	Taper-Buchse Taper bush	€ Stück ohne Buchse each without bush	Richt-durchmesser Datum diameter d_2 (mm)	Anzahl der Rillen No. of grooves	Ausführung Type		Gewicht ohne Buchse Weight without bush (= kg)	Taper-Buchse Taper bush	€ Stück ohne Buchse each without bush	
100▲	1	●	1	0,9	1610	34,50	200	1	●	8	5,0	2012	52,10	
	2	●	6	1,2	1610	36,80		2	●	8	5,4	2517	62,60	
	3	●	6	1,7	1610	42,80		3	●	2	6,5	2517	68,50	
112▲	1	●	1	1,1	1610	35,20	200	4	●	2	8,8	3020	79,40	
	2	●	6	1,5	1610	38,10		5	●	2	9,1	3020	89,10	
	3	●	6	2,0	1610	43,60		6	●	4	10,3	3020	99,90	
								8	●	4	13,5	3535	185,00	
118▲	1	●	1	1,3	1610	36,10	212	1	●	8	4,2	2012	56,80	
	2	●	6	1,7	1610	38,80		2	●	8	4,9	2517	68,50	
	3	●	6	2,3	1610	44,70		3	●	2	6,0	2517	74,30	
125▲	1	●	1	1,5	1610	36,80	212	4	●	2	9,8	3020	84,40	
	2	●	2	1,9	2012	39,70		5	●	2	11,0	3020	93,40	
	3	●	2	2,4	2012	46,30		6	●	4	14,3	3535	117,00	
	4	●	4	3,0	2012	52,90		8	●	4	16,6	3535	205,00	
	5	●	6	3,5	2012	62,30								
132▲	1	●	1	1,8	1610	39,30	224	1	●	8	4,7	2012	61,10	
	2	●	2	2,2	2012	43,20		2	●	8	5,3	2517	70,80	
	3	●	2	2,8	2012	50,60		3	●	2	6,3	2517	81,80	
	4	●	4	3,4	2012	59,50		4	●	2	11,3	3020	97,30	
	5	●	4	3,7	2012	69,20		5	●	2	12,7	3020	112,00	
140	1	●	1	2,3	1610	39,70	224	6	●	4	17,0	3535	135,00	
	2	●	2	2,7	2012	43,60		8	●	4	19,3	3535	221,00	
	3	●	2	3,3	2012	53,70		10	●	4	21,8	3535	278,00	
	4	●	2	3,7	2517	61,40		236	1	●	8	5,0	2012	63,50
	5	●	2	4,5	2517	71,60			2	●	8	5,5	2517	74,30
	6	●	4	4,6	2517	82,10			3	x	10	7,0	2517	88,70
						4	x		10	14,5	3020	107,00		
						5	●		6	16,9	3535	123,00		
						6	●		4	20,0	3535	146,00		
150	1	●	1	2,7	1610	42,10	236	8	●	4	22,3	3535	231,00	
	2	●	2	3,1	2012	45,50		10	●	4	25,3	3535	292,00	
	3	●	2	3,9	2517	56,40		250	1	●	8	5,4	2012	65,40
	4	●	2	4,4	2517	63,50			2	x	7	5,5	2517	80,90
	5	●	4	5,2	2517	73,50			3	●	2	7,7	3020	95,30
	6	●	4	5,6	2517	83,70			4	●	2	19,6	3020	111,00
						5	●		4	21,7	3535	134,00		
						6	●		4	23,3	3535	156,00		
160	1	●	1	2,5	1610	43,20	250	8	●	4	27,5	3535	234,00	
	2	●	2	2,9	2012	47,80		10	●	4	29,3	3535	305,00	
	3	●	2	4,2	2517	59,20		265	1	●	7	6,2	2517	193,00
	4	●	4	4,9	2517	66,90			2	○	9	8,0	3020	293,00
	5	●	4	6,0	2517	76,30			3	○	9	9,5	3020	369,00
	6	●	4	5,4	3020	86,80			4	○	9	16,7	3525	463,00
						6	○		9	24,0	3525	633,00		
						8	○		9	24,0	3525	633,00		
170	1	●	1	2,9	1610	45,20	280	1	x	7	6,1	2012	91,40	
	2	●	2	3,3	2012	52,10		2	x	7	6,8	2517	95,30	
	3	●	2	4,9	2517	60,70		3	x	10	8,6	3020	110,00	
	4	●	4	5,7	2517	69,20		4	○	9	10,1	3020	136,00	
	5	●	4	6,1	3020	79,00		5	○	9	17,8	3535	157,00	
	6	●	4	6,5	3020	89,50		6	○	9	19,6	3535	180,00	
	7	●	4	8,0	3020	99,90		8	○	9	26,7	3535	256,00	
	8	●	4	8,0	3020	99,90		10	○	9	30,5	3535	337,00	
180	1	●	1	4,1	1610	47,80	300	2	x	7	7,3	2517	103,00	
	2	●	8	4,5	2517	56,80		3	x	10	9,2	3020	117,00	
	3	●	2	5,5	2517	65,00		4	○	9	14,3	3020	135,00	
	4	●	4	6,9	2517	71,60		5	○	9	18,2	3535	151,00	
	5	●	4	7,1	3020	82,10		6	○	9	21,9	3535	185,00	
	6	●	4	7,7	3020	92,20		8	○	9	26,2	3535	291,00	
	7	●	4	9,5	3020	117,00								
	8	●	4	9,5	3020	117,00								
190	1	●	8	4,6	2012	49,80								
	2	●	8	5,0	2517	60,40								
	3	●	2	6,3	2517	68,10								
	4	●	4	7,6	2517	75,90								
	5	●	4	8,1	3020	85,20								
	6	●	4	9,2	3020	95,70								
	7	●	4	11,2	3030	179,00								
	8	●	4	11,2	3030	179,00								

▲ nur für Profil 17 only for section 17

Anzahl der Rillen No. of grooves z	1	2	3	4	5	6	8	10
Kranzbreite Face width b_2 (mm)	25	44	63	82	101	120	158	196

Taper-Buchse Taper bush	1610	2012	2517	3020	3030	3535
Bohrung d_2 (mm) von ... bis ... Bore d_2 (mm) from ... to ...	14-42	14-50	16-60	25-75	35-75	35-90
€/Stück each	11,00	13,50	16,90	22,00	28,80	55,50

- Vollscheibe Solid pulley
 - Bodenscheibe Plate pulley (mit oder ohne Spiegel with or without holes)
 - × Armscheibe Spoked pulley
- Material: EN-GJL 200 – DIN EN 1561

Bohrungsdurchmesser d_2 siehe Seite 3.
 Bore diameters d_2 see page 3.

Profil Section SPB/17

Richt- durchmesser Datum d ₂ (mm)	Anzahl der Rillen No. of grooves	Ausführung Type		Gewicht ohne Buchse Weight without bush (= kg)	Taper- Buchse Taper bush	€ Stück ohne Buchse each without bush	Richt- durchmesser Datum d ₂ (mm)	Anzahl der Rillen No. of grooves	Ausführung Type		Gewicht ohne Buchse Weight without bush (= kg)	Taper- Buchse Taper bush	€ Stück ohne Buchse each without bush	
315	1	x	7	7,2	2012	105,00	560	2	x	7	16,5	3030	233,00	
	2	x	7	7,8	2517	109,00		3	x	7	25,9	3535	296,00	
	3	x	10	9,6	3020	127,00		4	x	7	29,0	3535	343,00	
	4	O	5	17,1	3535	156,00		5	x	7	35,3	4040	422,00	
	5	O	9	18,8	3535	183,00		6	x	10	43,1	4040	487,00	
	6	O	9	23,0	3535	226,00		8	x	10	49,0	4545	690,00	
	8	O	9	26,0	3535	290,00		10*	x	10	55,7	4545	790,00	
10	O	9	31,5	3535	379,00	630	2	x	7	18,5	3020	309,00		
335	2	x	7	7,8	2517		119,00	3	x	7	28,9	3535	336,00	
	3	x	10	10,5	3020		140,00	4	x	7	33,3	3535	403,00	
	4	x	7	18,3	3535		162,00	5	x	7	43,1	4040	484,00	
	5	x	10	19,5	3535		190,00	6	x	10	49,2	4040	567,00	
	6	x	10	22,0	3535		248,00	8	x	10	62,0	4545	790,00	
	8	x	10	28,2	3535		331,00	10*	x	10	72,0	4545	911,00	
	10*	x	10	36,0	4040	402,00	710	3	x	7	33,2	3535	394,00	
355	2	x	7	8,7	3020	129,00		4	x	7	39,1	3535	465,00	
	3	x	10	10,8	3020	156,00		5	x	7	50,2	4040	589,00	
	4	x	7	18,6	3535	186,00		6	x	10	62,3	4545	670,00	
	5	x	10	20,8	3535	221,00		8	x	10	71,0	4545	883,00	
	6	O	9	22,8	3535	263,00		10*	x	10	80,0	4545	1.051,00	
	8	x	10	27,0	3535	340,00		800	3	x	7	36,7	3535	546,00
	10*	x	10	38,0	4040	435,00	4		x	7	48,8	4040	620,00	
375	2	x	7	9,5	3020	289,00	5		x	7	56,1	4040	766,00	
	3	x	10	11,5	3020	384,00	6		x	10	71,4	4545	853,00	
	4	x	10	16,5	3525	468,00	8		x	10	90,9	4545	1.075,00	
	6	x	10	25,0	3535	609,00	10*		x	10	102,0	4545	1.240,00	
	8	x	10	28,0	4040	783,00	900		3	x	7	46,8	3535	756,00
	400	2	x	7	10,0	3020		154,00	4	x	7	60,0	4040	828,00
		3	x	7	18,3	3535		190,00	5	x	7	74,8	4545	903,00
4		x	7	20,5	3535	225,00		6	x	10	81,5	4545	1.161,00	
5		x	10	23,4	3535	265,00		8	x	10	110,0	4545	1.320,00	
6		x	10	25,1	3535	312,00		10*	x	10	126,0	5050	1.616,00	
8		x	10	36,5	4040	408,00		1000	3	x	7	56,5	4040	1.006,00
10*		x	10	41,0	4040	529,00	4		x	7	66,5	4040	1.048,00	
425	2	x	7	11,5	3020	326,00	5		x	7	80,5	4545	1.177,00	
	3	x	7	18,0	3535	445,00	6		x	10	90,0	4545	1.390,00	
	4	x	7	19,5	3535	532,00	8		x	10	132,0	5050	1.668,00	
	6	x	10	25,1	4040	786,00	10*		x	10	147,0	5050	1.967,00	
	8	x	10	52,5	4545	962,00	450		2	x	7	12,1	3020	179,00
	450	3	x	7	21,9	3535		227,00	4	x	7	24,5	3535	269,00
		4	x	7	24,5	3535		269,00	5	x	10	27,3	3535	323,00
5		x	10	27,3	3535	323,00		6	x	10	35,5	4040	376,00	
6		x	10	35,5	4040	376,00		8	x	10	40,9	4040	517,00	
8		x	10	40,9	4040	517,00		10*	x	10	53,5	4545	610,00	
10*		x	10	53,5	4545	610,00		500	2	x	7	13,2	3020	201,00
500		3	x	7	23,1	3535	261,00		4	x	7	26,6	3535	303,00
	4	x	7	26,6	3535	303,00	5		x	10	29,9	3535	371,00	
	5	x	10	29,9	3535	371,00	6		x	10	38,9	4040	428,00	
	6	x	10	38,9	4040	428,00	8		x	10	45,5	4040	605,00	
	8	x	10	45,5	4040	605,00	10*		x	10	61,0	4545	690,00	
	10*	x	10	61,0	4545	690,00								

Anzahl der Rillen No. of grooves z	1	2	3	4	5	6	8	10
Kranzbreite Face width b ₂ (mm)	25	44	63	82	101	120	158	196

Taper-Buchse Taper bush	2012	2517	3020	3030	3535	4040	4545	5050
Bohrung d ₂ (mm) von ... bis ... Bore d ₂ (mm) from ... to ...	14-50	16-60	25-75	35-75	35-90	40-100	55-110	70-125
€/Stück each	13,50	16,90	22,00	28,80	55,50	78,00	99,30	159,00

- Vollscheibe Solid pulley
 - O Bodenscheibe Plate pulley
(mit oder ohne Spiegel with or without holes)
 - × Armscheibe Spoked pulley
- Material: EN-GJL 200 – DIN EN 1561
 * Keine Lagerware Non stock items

Bohrungsdurchmesser d₂ siehe Seite 3.
 Bore diameters d₂ see page 3.

Profil Section SPC/22

Richt- durchmesser Datum d _d (mm)	Anzahl der Rillen No. of grooves	Ausführung Type		Gewicht ohne Buchse Weight without bush (= kg)	Taper- Buchse Taper bush	€ Stück ohne Buchse each without bush	Richt- durchmesser Datum d _d (mm)	Anzahl der Rillen No. of grooves	Ausführung Type		Gewicht ohne Buchse Weight without bush (= kg)	Taper- Buchse Taper bush	€ Stück ohne Buchse each without bush	
		●	○						○	○				
200▲	3	●	4	9,0	2517	151,00	355	3	○	5	22,9	3535	296,00	
	4	●	4	10,5	3020	167,00		4	○	9	28,3	3535	335,00	
	5	●	4	14,0	3535	204,00		5	○	9	32,5	3535	382,00	
	6	●	4	17,0	3535	229,00		6	○	9	36,0	3535	444,00	
212▲	3	●	4	10,0	3020	167,00		8	○	9	67,5	4040	583,00	
	4	●	4	12,5	3020	187,00		10*	○	9	121,0	4545	716,00	
	5	●	4	15,0	3535	225,00		375	3	○	5	23,8	3535	321,00
	6	●	4	18,0	3535	251,00			4	○	9	30,0	3535	373,00
224	2	●	4	8,1	3020	182,00			5	○	9	33,0	3535	421,00
	3	●	4	11,0	3020	190,00			6	○	9	45,5	4040	494,00
	4	●	4	14,0	3535	213,00		8	○	9	68,0	4545	637,00	
	5	●	4	16,2	3535	256,00		400	3	x	7	24,1	3535	370,00
6	●	4	19,0	3535	285,00	4			x	10	28,0	3535	416,00	
8	●	4	24,9	3535	351,00	5			x	10	34,0	3535	452,00	
236	3	●	4	12,0	3020	215,00			6	○	9	48,0	4040	530,00
	4	●	4	17,2	3535	259,00		8	○	9	65,0	4545	653,00	
	5	●	4	19,1	3535	280,00	10*	○	9	88,0	5050	798,00		
	6	●	4	20,8	3535	316,00	425	3	x	7	26,0	3535	389,00	
8	●	4	25,5	3535	373,00	4		x	10	31,0	3535	439,00		
250	2	●	4	9,8	3020	209,00		5	○	9	45,0	4040	480,00	
	3	●	4	14,5	3020	217,00		6	○	9	58,0	4545	569,00	
	4	●	4	20,7	3535	243,00	8	○	9	74,0	4545	723,00		
	5	●	4	22,8	3535	271,00	450	3	x	7	28,6	3535	418,00	
6	●	4	26,0	3535	310,00	4		x	10	33,5	3535	479,00		
8	●	4	29,7	3535	404,00	5		x	10	45,0	4040	536,00		
10*	●	4	34,0	4040	542,00	6		○	9	61,1	4545	592,00		
265	3	●	8	21,2	3535	232,00	8	○	9	78,7	5050	745,00		
	4	○	9	24,0	3535	280,00	10*	○	9	101,0	5050	837,00		
	5	○	9	26,2	3535	312,00	475	3	x	7	40,0	3535	438,00	
	6	○	9	29,0	3535	351,00		4	x	10	47,0	3535	486,00	
8	○	9	33,3	3535	430,00	5		x	10	47,2	4040	546,00		
280	3	●	8	24,0	3535	244,00		6	○	9	62,8	4545	624,00	
	4	○	9	29,0	3535	274,00	8	○	9	81,5	5050	796,00		
	5	○	9	31,0	3535	317,00	500	3	x	7	30,9	3535	450,00	
	6	○	9	33,8	3535	361,00		4	x	10	39,0	3535	509,00	
8	○	9	37,5	3535	449,00	5		x	10	48,7	4040	606,00		
10*	○	9	45,0	4040	585,00	6		x	10	60,2	4545	666,00		
300	3	○	5	21,0	3535	271,00	8	○	9	87,4	5050	870,00		
	4	○	9	25,0	3535	301,00	10*	○	9	127,0	5050	996,00		
	5	○	9	28,5	3535	342,00	560	3	x	7	36,0	3535	592,00	
	6	○	9	29,0	3535	375,00		4	x	10	50,0	4040	607,00	
8	●	4	46,5	4040	503,00	5		x	10	63,0	4545	670,00		
10*	○	9	53,5	4545	618,00	6		x	10	77,0	5050	738,00		
315	3	○	5	21,6	3535	271,00	8	x	10	94,0	5050	953,00		
	4	○	9	24,6	3535	299,00	10*	○	9	115,0	5050	1.070,00		
	5	○	9	29,0	3535	335,00	630	3	x	7	48,5	4040	637,00	
	6	○	9	31,4	3535	391,00		4	x	7	61,0	4545	694,00	
8	●	4	50,0	4040	540,00	5		x	10	77,0	5050	769,00		
10*	○	9	58,0	4545	651,00	6		x	10	86,0	5050	862,00		
335	3	○	5	22,5	3535	286,00	8	x	10	105,5	5050	1.050,00		
	4	○	9	26,5	3535	334,00	10*	○	9	130,0	5050	1.239,00		
	5	○	9	30,0	3535	379,00	710	3	x	7	62,5	4040	878,00	
	6	○	9	35,0	3535	437,00		4	x	7	78,6	4545	913,00	
8	○	9	58,0	4040	574,00	5		x	10	89,6	5050	914,00		
								6	x	10	99,4	5050	1.028,00	
							8	x	10	117,5	5050	1.257,00		
							10*	○	9	137,1	5050	1.461,00		

▲ nur für Profil 22 only for section 22

Anzahl der Rillen No. of grooves z	2	3	4	5	6	8	10
Kranzbreite Face width b ₂ (mm)	59,5	85	110,5	136	161,5	212,5	263,5
Taper-Buchse Taper bush	2517	3020	3535	4040	4545	5050	
Bohrung d ₂ (mm) von ... bis ... Bore d ₂ (mm) from ... to ...	16-60	25-75	35-90	40-100	55-110	70-125	
€/Stück each	16,90	22,00	55,50	78,00	99,30	159,00	

- Vollscheibe Solid pulley
 - Bodenscheibe Plate pulley
(mit oder ohne Spiegel with or without holes)
 - × Armscheibe Spoked pulley
- Material: EN-GJL 200 – DIN EN 1561
 * Keine Lagerware Non stock items

Bohrungsdurchmesser d₂ siehe Seite 3.
 Bore diameters d₂ see page 3.

Profil Section SPC/22

Richt- durchmesser Datum d ₂ (mm)	Anzahl der Rillen No. of grooves	Ausführung Type		Gewicht ohne Buchse Weight without bush (= kg)	Taper- Buchse Taper bush	€ Stück ohne Buchse each without bush	Richt- durchmesser Datum d ₂ (mm)	Anzahl der Rillen No. of grooves	Ausführung Type		Gewicht ohne Buchse Weight without bush (= kg)	Taper- Buchse Taper bush	€ Stück ohne Buchse each without bush	
800	3	x	7	72,0	4545	917,00	1250	5	x	10	177,6	5050	1.863,00	
	4	x	7	90,8	5050	923,00		6	x	10	201,4	5050	2.094,00	
	5	x	10	102,5	5050	1.051,00		8	x	10	243,7	5050	2.587,00	
	6	x	10	113,7	5050	1.122,00		10*	O	9	292,1	5050	3.033,00	
	8	x	10	136,6	5050	1.351,00								
	10*	O	9	160,7	5050	1.640,00								
1000	5	x	10	134,0	5050	1.377,00								
	6	x	10	150,0	5050	1.564,00								
	8	x	10	181,4	5050	2.013,00								
	10*	O	9	217,2	5050	2.288,00								

Anzahl der Rillen No. of grooves z	3	4	5	6	8	10
Kranzbreite Face width b ₂ (mm)	85	110,5	136	161,5	212,5	263,5
Taper-Buchse Taper bush	4545			5050		
Bohrung d ₂ (mm) von ... bis ... Bore d ₂ (mm) from ... to ...	55-110			70-125		
€/Stück each	99,30			159,00		

- Vollscheibe Solid pulley
 - O Bodenscheibe Plate pulley
(mit oder ohne Spiegel with or without holes)
 - × Armscheibe Spoked pulley
- Material: EN-GJL 200 – DIN EN 1561
 * Keine Lagerware Non stock items

Bohrungsdurchmesser d₂ siehe Seite 3.
 Bore diameters d₂ see page 3.

Profil Section SPZ/10

Richt- durchmesser Datum d _d (mm)	Anzahl der Rillen No. of grooves	Aus- führung Type	Gewicht Weight (≈ kg)	Fertig- bohrung Finished bore d _{max} (mm)	Naben- länge Hub length l (mm)	€ Stück zentriert each centered	Richt- durchmesser Datum d _d (mm)	Anzahl der Rillen No. of grooves	Aus- führung Type	Gewicht Weight (≈ kg)	Fertig- bohrung Finished bore d _{max} (mm)	Naben- länge Hub length l (mm)	€ Stück zentriert each centered
45▲	1	O	0,2	16	24	7,20	170	1	x	1,7	40	30	21,30
	2	O	0,3	16	35	10,70		2	x	1,9	40	38	31,40
	3	O	0,4	16	35	13,50		3	x	3,0	42	40	42,70
50▲	1	O	0,3	20	24	7,80	180	1	x	2,1	32	30	23,40
	2	O	0,4	20	35	10,70		2	x	3,1	38	38	34,10
	3	O	0,5	20	40	15,00		3	x	3,5	42	40	44,10
56▲	1	O	0,3	20	24	7,80	190	1	x	2,3	35	30	25,60
	2	O	0,5	25	35	10,70		2	x	2,4	35	38	35,50
	3	O	0,7	25	40	15,00		3	x	4,0	35	40	47,00
63	1	O	0,3	25	24	7,80	200	1	x	2,4	32	38	27,10
	2	O	0,6	25	35	10,70		2	x	2,9	38	38	37,70
	3	O	0,9	25	40	15,60		3	x	4,5	42	40	48,40
71	1	O	0,3	25	24	7,80	212	1	x	2,6	35	30	32,00
	2	O	0,6	25	35	11,30		2	x	3,4	35	38	40,60
	3	O	1,0	30	40	16,40		3	x	5,0	38	40	52,60
75	1	O	0,4	24	24	7,80	225	1	x	2,8	32	38	34,10
	2	O	0,6	24	35	12,10		2	x	4,0	38	38	44,80
	3	O	1,1	28	40	18,50		3	x	5,3	42	40	56,90
80	1	O	0,4	25	24	7,80	250	1	x	3,3	32	38	37,00
	2	O	0,7	30	35	12,80		2	x	4,8	38	38	50,50
	3	O	1,1	38	35	19,30		3	x	6,0	42	40	66,10
85	1	O	0,3	25	24	8,60	280	1	x	3,9	35	34	47,00
	2	O	0,7	30	35	15,00		2	x	5,2	42	38	61,20
	3	O	1,1	38	35	20,70		3	x	7,0	48	40	78,20
90	1	O	0,4	25	24	8,60	315	1	x	4,4	35	34	56,20
	2	O	0,8	30	35	15,60		2	x	6,8	42	38	70,40
	3	O	1,2	38	38	21,30		3	x	8,3	48	40	83,90
95	1	O	0,4	28	24	10,00	355	1	x	4,6	35	34	68,30
	2	O	0,8	28	35	16,40		2	x	8,0	42	40	81,80
	3	O	1,2	38	38	22,80		3	x	10,0	48	45	98,90
100	1	O	0,5	28	24	10,70							
	2	O	0,9	30	35	16,40							
	3	O	1,3	38	38	24,20							
106	1	O	0,5	30	24	11,30							
	2	O	1,0	28	35	18,50							
	3	O	1,3	38	38	25,60							
112	1	O	0,5	28	24	12,10							
	2	O	1,0	30	35	19,90							
	3	O	1,4	38	38	27,10							
118	1	O	0,6	28	24	12,80							
	2	O	1,1	38	35	21,30							
	3	O	1,5	38	38	28,50							
125	1	O	0,7	28	24	13,50							
	2	O	1,2	38	35	22,80							
	3	O	1,6	38	40	29,90							
132	1	O	0,8	30	24	15,60							
	2	O	1,3	38	35	23,40							
	3	O	1,6	40	40	31,40							
140	1	O	0,9	28	24	16,40							
	2	O	1,4	38	38	25,60							
	3	O	1,7	38	40	32,00							
150	1	x	1,1	28	24	18,50							
	2	O	1,5	38	38	27,10							
	3	O	1,9	38	40	38,40							
160	1	x	1,2	32	30	20,70							
	2	x	1,6	38	38	29,20							
	3	x	2,4	42	40	42,70							
▲ nur für Profil 10 only for section 10													

Anzahl der Rillen No. of grooves z	1	2	3
Kranzbreite Face width b ₂ (mm)	16	28	40

- Vollscheibe Solid pulley
 - O Bodenscheibe Plate pulley (mit oder ohne Spiegel with or without holes)
 - x Armscheibe Spoked pulley
- Nabenlage: einseitig bündig Hub position: one side flush
 Material: EN-GJL 200 – DIN EN 1561

Profil Section SPA/13

Richt- durchmesser Datum d _d (mm)	Anzahl der Rillen No. of grooves	Aus- führung Type	Gewicht Weight (≈ kg)	Fertig- bohrung Finished bore d _{max} (mm)	Naben- länge Hub length l (mm)	€ Stück zentriert each centered	Richt- durchmesser Datum d _d (mm)	Anzahl der Rillen No. of grooves	Aus- führung Type	Gewicht Weight (≈ kg)	Fertig- bohrung Finished bore d _{max} (mm)	Naben- länge Hub length l (mm)	€ Stück zentriert each centered
50▲	1	O	0,3	18	34	7,80	125	1	O	1,4	32	34	16,40
	2	O	0,5	18	49	11,30		2	O	1,9	38	49	23,40
	3	O	0,6	18	47	16,40		3	O	2,6	42	42	30,60
56▲	1	O	0,4	20	34	7,80		4▽	O	3,5	42	53	40,60
	2	O	0,6	20	49	12,80		5▽	O	4,4	48	65	48,40
	3	O	0,7	20	47	17,10	132	1	O	1,5	32	34	17,10
63▲	1	O	0,5	25	34	7,80		2	O	2,2	38	49	25,60
	2	O	0,8	25	49	12,80		3	O	2,6	42	42	34,10
	3	O	0,9	25	47	17,10		4▽	O	3,6	42	53	41,90
	4▽	O	1,2	25	60	22,80		5▽	O	4,8	48	65	50,50
	5▽	O	1,5	25	70	29,20	140	1	O	1,5	32	34	19,30
71▲	1	O	0,5	25	34	7,80		2	O	2,3	38	49	27,10
	2	O	0,9	28	49	14,20		3	O	2,6	42	42	35,50
	3	O	1,0	32	42	19,30		4▽	O	3,7	42	53	44,80
	4▽	O	1,5	32	60	23,50		5▽	O	5,0	48	65	52,60
	5▽	O	1,8	32	70	29,20	150	1	x	1,6	38	36	20,70
75▲	1	O	0,5	24	34	8,60		2	x	2,6	38	49	29,20
	2	O	1,0	24	49	15,00		3	O	3,0	42	42	36,30
	3	O	1,1	24	42	19,90		4▽	O	4,0	42	53	47,00
	4▽	O	1,8	24	60	26,30		5▽	O	5,2	48	65	55,40
	5▽	O	1,9	28	82	30,60	160	1	x	1,8	38	36	22,80
80▲	1	O	0,6	28	34	9,20		2	x	2,4	38	49	32,00
	2	O	1,0	32	49	15,00		3	x	2,8	42	42	40,60
	3	O	1,2	38	42	21,40		4▽	O	3,6	48	60	49,10
	4▽	O	1,9	38	60	26,30		5▽	O	5,5	48	70	56,90
	5▽	O	2,0	38	55	33,40	170	1	x	2,0	35	36	23,40
85	1	O	0,6	24	34	10,00		2	x	2,9	35	49	34,10
	2	O	1,2	28	49	16,40		3	x	3,2	35	42	42,70
	3	O	1,4	28	42	21,30		4▽	x	4,2	35	60	51,30
	4▽	O	2,0	28	53	27,70		5▽	x	5,8	38	70	64,70
	5▽	O	2,2	32	55	34,90	180	1	x	2,0	38	36	25,60
90	1	O	0,9	28	34	10,70		2	x	3,2	42	49	35,50
	2	O	1,5	32	49	16,40		3	x	3,6	42	42	44,80
	3	O	1,6	38	42	23,40		4▽	x	4,7	48	60	55,40
	4▽	O	2,2	42	53	29,90		5▽	x	6,1	48	70	67,50
	5▽	O	2,5	42	67	36,30	190	1	x	2,0	38	36	27,70
95	1	O	0,8	28	34	11,30		2	x	3,2	42	49	37,00
	2	O	1,6	28	49	18,50		3	x	4,0	42	42	48,40
	3	O	1,9	28	42	24,20		4▽	x	5,2	48	60	59,10
	4▽	O	2,5	32	53	32,00		5▽	x	6,3	48	70	71,20
	5▽	O	2,8	35	67	38,40	200	1	x	2,4	38	36	29,20
100	1	O	0,8	28	34	12,10		2	x	2,9	42	49	39,20
	2	O	1,4	32	49	18,50		3	x	4,2	48	42	49,80
	3	O	2,0	38	42	24,90		4▽	x	5,0	55	60	61,20
	4▽	O	2,7	42	53	32,00		5▽	x	6,5	55	70	73,90
	5▽	O	3,1	42	60	38,40	212	1	x	2,7	40	36	31,40
106	1	O	0,9	28	34	12,10		2	x	3,4	42	49	41,90
	2	O	1,7	28	49	19,90		3	x	4,4	42	42	56,90
	3	O	2,2	32	42	27,10		4▽	x	5,7	42	60	64,70
	4▽	O	3,2	32	53	34,10		5▽	x	6,9	42	70	81,10
	5▽	O	3,9	35	60	41,90	225	1	x	2,8	40	36	34,90
112	1	O	1,1	28	34	13,50		2	x	3,9	42	49	44,80
	2	O	1,8	38	49	21,30		3	x	4,6	42	42	58,30
	3	O	2,4	38	42	27,70		4▽	x	6,5	42	60	69,00
	4▽	O	3,4	42	53	35,50		5▽	x	7,3	42	70	84,60
	5▽	O	4,0	42	60	42,70	236	1	x	3,3	38	36	37,70
118	1	O	1,1	32	34	15,00		2	x	4,1	42	49	49,10
	2	O	1,8	38	49	22,80		3	x	4,9	48	47	64,00
	3	O	2,4	42	42	29,90		4▽	x	6,2	55	60	75,40
	4▽	O	3,4	42	53	37,70		5▽	x	7,5	55	70	91,10
	5▽	O	4,1	48	65	47,00							

▲ nur für Profil 13 only for section 13

▽ d_d + 4 mm

Anzahl der Rillen No. of grooves z	1	2	3	4	5
Kranzbreite Face width b ₂ (mm)	20	35	50	67	82

- Vollscheibe Solid pulley
 - Bodenscheibe Plate pulley (mit oder ohne Spiegel with or without holes)
 - × Armscheibe Spoked pulley
- Nabenlage: einseitig bündig Hub position: one side flush
 Material: EN-GJL 200 – DIN EN 1561

Profil Section SPA/13

Richt- durchmesser Datum d _d (mm)	Anzahl der Rillen No. of grooves	Aus- führung Type	Gewicht Weight (≈ kg)	Fertig- bohrung Finished bore d _{max} (mm)	Naben- länge Hub length l (mm)	€ Stück zentriert each centered	Richt- durchmesser Datum d _d (mm)	Anzahl der Rillen No. of grooves	Aus- führung Type	Gewicht Weight (≈ kg)	Fertig- bohrung Finished bore d _{max} (mm)	Naben- länge Hub length l (mm)	€ Stück zentriert each centered
250	1	x	3,4	42	36	39,20	400	1▽	x	6,9	50	50	90,30
	2	x	4,3	48	49	51,90		2▽	x	8,8	55	53	114,00
	3	x	5,3	48	47	68,30		3▽	x	10,5	60	47	143,00
	4▽	x	7,0	55	60	80,40		4▽	x	12,4	60	67	161,00
	5▽	x	7,9	60	70	96,70		5▽	x	15,9	60	82	186,00
280	1	x	3,9	42	44	49,80	450	1▽	x	7,5	55	50	111,00
	2	x	5,4	48	53	63,30		2▽	x	9,4	55	53	133,00
	3	x	6,5	48	47	80,40		3▽	x	12,2	60	47	158,00
	4▽	x	8,5	55	60	99,60		4▽	x	14,2	65	67	184,00
	5▽	x	9,9	60	70	118,00		5▽	x	18,3	65	82	219,00
300	1	x	4,3	48	44	54,00	500	1▽	x	10,5	55	50	131,00
	2	x	5,9	48	53	70,40		2▽	x	10,7	55	55	152,00
	3	x	7,5	55	47	90,30		3▽	x	13,5	60	60	175,00
	4▽	x	9,8	55	60	108,00		4▽	x	16,3	65	67	217,00
	5▽	x	11,3	60	70	122,00		5▽	x	22,8	65	82	236,00
315	1	x	4,8	48	44	60,50	560	1▽	x	14,0	55	60	153,00
	2	x	6,6	48	53	79,00		2▽	x	13,1	55	60	182,00
	3	x	8,8	55	47	98,10		3▽	x	15,6	60	74	213,00
	4▽	x	11,1	55	60	120,00		4▽	x	19,4	65	67	258,00
	5▽	x	12,5	60	70	127,00		5▽	x	24,5	65	82	266,00
355	1	x	5,5	48	44	69,00							
	2	x	7,7	55	53	91,70							
	3	x	9,6	55	47	118,00							
	4▽	x	11,8	55	60	138,00							
	5▽	x	13,8	60	70	163,00							
▽ d _d + 4 mm													

Anzahl der Rillen No. of grooves z	1	2	3	4	5
Kranzbreite Face width b ₂ (mm)	20	35	50	67	82

- Vollscheibe Solid pulley
 - Bodenscheibe Plate pulley (mit oder ohne Spiegel with or without holes)
 - × Armscheibe Spoked pulley
- Nabenlage: einseitig bündig Hub position: one side flush
 Material: EN-GJL 200 – DIN EN 1561

Profil Section SPB/17

Richt-durchmesser Datum diameter d_d (mm)	Anzahl der Rillen No. of grooves	Aus-führung Type	Gewicht Weight (\approx kg)	Fertig-bohrung Finished bore d_{max} (mm)	Naben-länge Hub length l (mm)	€ Stück zentriert each centered	Richt-durchmesser Datum diameter d_d (mm)	Anzahl der Rillen No. of grooves	Aus-führung Type	Gewicht Weight (\approx kg)	Fertig-bohrung Finished bore d_{max} (mm)	Naben-länge Hub length l (mm)	€ Stück zentriert each centered
56▲	1	O	0,6	20	41	10,00	132▲	1	O	1,9	30	41	19,90
	2	O	1,0	20	60	15,60		2	O	2,6	30	60	31,40
	3	O	1,1	22	62	22,80		3	O	3,5	42	55	42,70
63▲	1	O	0,8	20	41	10,00		4∇	O	6,3	42	70	53,40
	2	O	1,2	20	60	15,60		5∇	O	9,4	42	75	66,90
	3	O	1,2	22	62	23,40		6∇	O	8,5	42	85	84,60
71▲	1	O	0,8	22	41	10,00	140	1	O	2,1	32	41	21,30
	2	O	1,3	22	60	15,60		2	O	2,9	38	60	32,70
	3	O	1,6	22	55	24,90		3	O	3,9	42	55	44,80
75▲	1	O	0,8	25	41	10,70		4∇	O	6,9	42	70	59,70
	2	O	1,4	25	60	17,10		5∇	O	7,6	48	75	73,30
	3	O	1,9	25	62	24,90		6∇	O	11,4	48	85	88,20
80▲	1	O	1,0	28	41	11,30	150	1	O	2,4	32	43	24,90
	2	O	1,7	28	60	18,50		2	O	3,2	38	48	38,40
	3	O	2,1	28	55	26,30		3	O	4,3	42	60	49,10
	4∇	O	2,4	28	70	34,90		4∇	O	6,8	42	70	63,30
	5∇	O	2,7	28	80	41,90		5∇	O	8,4	48	75	76,80
85▲	1	O	1,1	30	41	11,30		6∇	O	12,1	48	85	93,80
	2	O	1,7	30	60	19,30	160	1	x	2,5	38	43	27,10
	3	O	2,2	30	55	28,50		2	x	3,3	42	48	40,60
	4∇	O	2,7	30	70	36,30		3	x	4,6	48	60	51,30
	5∇	O	3,0	30	75	44,10		4∇	O	7,0	48	70	65,50
90▲	1	O	1,2	32	41	12,10		5∇	O	9,4	48	75	81,10
	2	O	1,8	38	60	20,70		6∇	O	12,9	55	85	100,00
	3	O	2,3	38	55	29,90	170	1	x	2,9	42	43	31,40
	4∇	O	3,1	38	70	38,40		2	x	3,4	42	48	42,70
	5∇	O	3,3	38	75	45,50		3	x	4,9	42	60	56,20
95▲	1	O	1,3	35	41	12,80		4∇	O	7,2	48	70	70,40
	2	O	2,0	38	60	21,40		5∇	O	8,9	48	75	86,00
	3	O	2,5	38	67	32,00		6∇	O	13,1	48	85	106,00
	4∇	O	2,9	38	70	39,80	180	1	x	3,1	38	43	32,00
	5∇	O	3,6	38	75	49,10		2	x	3,9	42	48	44,80
100▲	1	O	1,3	32	41	15,00		3	x	5,3	48	60	61,20
	2	O	2,1	38	60	23,40		4∇	x	7,4	48	70	75,40
	3	O	2,9	38	55	33,40		5∇	O	9,1	55	75	92,50
	4∇	O	3,8	38	70	42,70		6∇	O	10,8	60	85	111,00
	5∇	O	4,5	38	75	51,90	190	1	x	3,2	42	43	35,50
	6∇	O	5,2	38	124	68,30		2	x	4,2	42	48	49,80
106▲	1	O	1,5	28	41	15,60		3	x	5,5	42	60	64,70
	2	O	2,0	28	60	24,90		4∇	x	7,7	48	70	81,10
	3	O	3,0	30	55	34,90		5∇	O	9,2	50	75	97,50
	4∇	O	4,3	30	70	44,80		6∇	O	12,0	55	85	119,00
	5∇	O	5,1	32	75	54,00	200	1	x	3,4	38	43	37,70
	6∇	O	6,0	32	124	71,20		2	x	4,5	42	48	52,60
112▲	1	O	1,5	32	41	15,60		3	x	5,9	48	60	69,00
	2	O	2,4	38	60	25,60		4∇	x	8,0	50	60	86,00
	3	O	3,1	38	55	36,30		5∇	O	9,5	55	80	107,00
	4∇	O	4,8	42	67	47,00		6∇	O	12,2	60	90	131,00
	5∇	O	5,6	42	75	58,30	212	1	x	3,8	42	43	41,90
	6∇	O	6,2	42	85	81,80		2	x	4,7	42	48	57,60
118▲	1	O	1,6	32	41	17,10		3	x	6,2	48	60	73,90
	2	O	2,4	38	60	27,70		4∇	x	7,7	50	70	92,50
	3	O	3,2	42	55	38,40		5∇	x	10,3	50	80	111,00
	4∇	O	5,2	42	70	49,10		6∇	O	13,5	55	90	138,00
	5∇	O	7,2	42	75	63,30	225	1	x	4,0	42	43	44,80
	6∇	O	6,6	42	85	79,60		2	x	5,4	42	48	61,20
125▲	1	O	1,7	32	41	18,50		3	x	6,9	48	60	79,00
	2	O	2,6	38	60	29,20		4∇	x	8,6	55	70	100,00
	3	O	3,3	42	55	39,20		5∇	O	11,7	50	90	119,00
	4∇	O	4,7	42	70	50,50		6∇	O	14,8	55	90	152,00
	5∇	O	8,6	42	75	64,70							
	6∇	O	8,0	48	85	82,50							

▲ nur für Profil 17 only for section 17

∇ $d_d + 5,5$ mm

Anzahl der Rillen No. of grooves z	1	2	3	4	5	6
Kranzbreite Face width b_2 (mm)	25	44	63	86	105	124

- Vollscheibe Solid pulley
 - O Bodenscheibe Plate pulley (mit oder ohne Spiegel with or without holes)
 - x Armscheibe Spoked pulley
- Nabenlage: einseitig bündig Hub position: one side flush
 Material: EN-GJL 200 – DIN EN 1561

Profil Section SPB/17

Richt- durchmesser Datum d _d (mm)	Anzahl der Rillen No. of grooves	Aus- führung Type	Gewicht Weight (≈ kg)	Fertig- bohrung Finished bore d _{max} (mm)	Naben- länge Hub length l (mm)	€ Stück zentriert each centered	Richt- durchmesser Datum d _d (mm)	Anzahl der Rillen No. of grooves	Aus- führung Type	Gewicht Weight (≈ kg)	Fertig- bohrung Finished bore d _{max} (mm)	Naben- länge Hub length l (mm)	€ Stück zentriert each centered
250	1	x	4,2	42	43	52,60	400	1▽	x	8,5	50	49	111,00
	2	x	6,1	48	55	71,20		2▽	x	10,0	55	55	141,00
	3	x	8,6	55	60	91,70		3▽	x	14,3	60	67	167,00
	4▽	x	9,8	60	70	116,00		4▽	x	18,5	65	80	230,00
	5▽	x	13,2	65	80	135,00		5▽	x	22,5	70	85	240,00
	6▽	x	17,0	65	90	163,00		6▽	x	28,0	75	90	264,00
280	1	x	5,7	48	49	61,90	450	1▽	x	9,9	50	55	120,00
	2	x	7,0	48	55	83,90		2▽	x	10,9	55	55	167,00
	3	x	9,7	55	60	105,00		3▽	x	15,1	60	67	197,00
	4▽	x	11,5	60	70	127,00		4▽	x	20,5	65	80	260,00
	5▽	x	15,5	65	80	152,00		5▽	x	26,0	70	80	310,00
	6▽	x	18,0	65	90	180,00		6▽	x	28,9	75	90	362,00
300	1	x	5,9	48	49	69,00	500	1▽	x	10,7	50	55	141,00
	2	x	7,5	48	55	92,50		2▽	x	13,7	60	59	184,00
	3	x	10,5	55	67	114,00		3▽	x	15,2	65	67	226,00
	4▽	x	12,4	60	80	138,00		4▽	x	21,3	70	80	300,00
	5▽	x	16,5	65	80	165,00		5▽	x	30,0	75	80	375,00
	6▽	x	18,3	70	90	192,00		6▽	x	33,8	80	90	498,00
315	1	x	6,4	48	49	74,70	560	2▽	x	15,0	60	55	243,00
	2	x	8,2	55	55	93,20		3▽	x	24,2	65	67	314,00
	3	x	12,9	55	67	124,00		4▽	x	26,0	70	80	387,00
	4▽	x	13,0	60	80	150,00		5▽	x	34,4	75	80	455,00
	5▽	x	17,6	65	80	173,00		6▽	x	39,0	80	90	525,00
	6▽	x	20,6	75	90	196,00		630	2▽	x	20,2	60	80
355	1	x	7,0	48	49	88,20	3▽		x	27,0	65	80	353,00
	2	x	9,7	55	55	119,00	4▽		x	30,8	75	86	478,00
	3	x	13,4	55	67	143,00	5▽		x	37,2	80	90	530,00
	4▽	x	18,3	60	80	186,00	6▽		x	44,0	90	100	589,00
	5▽	x	18,8	65	75	197,00							
	6▽	x	19,8	75	90	238,00							

▽ d_d + 5,5 mm

Anzahl der Rillen No. of grooves z	1	2	3	4	5	6
Kranzbreite Face width b ₂ (mm)	25	44	63	86	105	124

- Vollscheibe Solid pulley
 - Bodenscheibe Plate pulley (mit oder ohne Spiegel with or without holes)
 - × Armscheibe Spoked pulley
- Nabenlage: einseitig bündig Hub position: one side flush
 Material: EN-GJL 200 – DIN EN 1561

Profil Section SPC/22 (keine Lagerware non stock items)

Richt- durchmesser Datum d _d (mm)	Anzahl der Rillen No. of grooves	Aus- führung Type	Gewicht Weight (≈ kg)	Fertig- bohrung Finished bore d _{max} (mm)	Naben- länge Hub length l (mm)	€ Stück zentriert each centered	Richt- durchmesser Datum d _d (mm)	Anzahl der Rillen No. of grooves	Aus- führung Type	Gewicht Weight (≈ kg)	Fertig- bohrung Finished bore d _{max} (mm)	Naben- länge Hub length l (mm)	€ Stück zentriert each centered	
180	1	O	4,2	40	54	66,90	335	2	x	14,0	55	74	156,00	
	2	O	7,2	50	64	76,80		3	x	18,3	55	90	199,00	
	3	O	10,4	55	90	96,70		4	x	22,4	60	95	254,00	
	4	O	10,5	55	95	152,00		5	x	28,3	65	100	316,00	
	5	O	18,0	60	100	173,00		6	x	34,4	75	115	371,00	
	6	O	23,6	65	115	197,00								
200	1	O	4,8	40	54	75,40	355	2	x	15,2	60	74	151,00	
	2	O	7,8	50	64	84,60		3	x	19,2	70	90	203,00	
	3	O	8,8	55	90	107,00		4	x	25,8	70	95	257,00	
	4	O	11,2	60	95	177,00		5	x	32,0	75	100	305,00	
	5	O	15,4	65	100	200,00		6	x	36,2	75	115	353,00	
	6	O	27,0	70	125	223,00								
225	1	x	5,5	48	54	86,00	400	3	x	20,6	70	90	233,00	
	2	x	7,8	52	64	113,00		4	x	28,0	70	105	256,00	
	3	x	10,6	52	90	118,00		5	x	32,0	75	100	391,00	
	4	x	13,1	55	95	202,00	450	2	x	21,1	70	80	197,00	
	5	x	16,7	60	100	211,00		3	x	26,3	75	90	279,00	
	6	x	35,0	60	115	239,00		4	x	31,1	75	105	310,00	
250	1	x	7,3	52	54	93,20	500	5	x	42,2	80	110	421,00	
	2	x	8,8	52	64	123,00		6	x	48,5	80	120	469,00	
	3	x	11,0	65	90	143,00		560	3	x	31,1	75	90	370,00
	4	x	15,3	70	95	219,00			4	x	39,0	75	105	424,00
	5	x	19,0	75	100	224,00			5	x	54,1	80	110	566,00
	6	x	23,7	60	115	247,00		6	x	61,5	85	120	728,00	
280	1	x	8,7	52	54	108,00	630	3	x	38,5	80	90	438,00	
	2	x	10,9	55	64	134,00		4	x	48,1	80	105	576,00	
	3	x	15,6	70	90	167,00		5	x	62,2	85	110	659,00	
	4	x	17,5	75	95	239,00		6	x	73,2	85	120	924,00	
	5	x	20,5	75	100	270,00								
315	1	x	9,1	52	54	116,00								
	2	x	13,0	55	74	143,00								
	3	x	17,1	70	90	195,00								
	4	x	20,0	75	95	251,00								
	5	x	24,7	80	100	286,00								
	6	x	31,2	85	115	338,00								

Anzahl der Rillen No. of grooves z	1	2	3	4	5	6
Kranzbreite Face width b ₂ (mm)	38	64	90	116	142	168

- Vollscheibe Solid pulley
 - O Bodenscheibe Plate pulley
(mit oder ohne Spiegel with or without holes)
 - x Armscheibe Spoked pulley
- Nabenlage: einseitig bündig Hub position: one side flush
 Material: EN-GJL 200 – DIN EN 1561

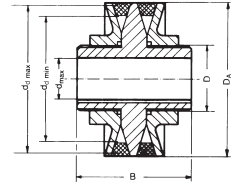
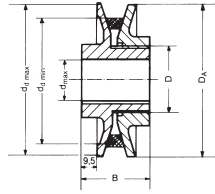

Regelscheiben für zylindrische Bohrung Variable speed pulleys for plain boring										Material: GG
Bezeichnung Part Number	D _A (mm)	D (mm)	Fertigbohrung Finished bore d _{max} (mm)	B (mm)	Profil Section	d _{d min} (mm)	d _{d max} (mm)	Regel- faktor Variance factor	Gewicht Weight (= kg)	€ Stück zentriert each centered
R 083-1	83	40	26	48	SPZ Z/10	63 57	79 77	1,25 1,35	0,90	53,80
R 093-1	93	45	28	48	SPZ SPA Z/10 A/13	67 66 61 60	89 87 87 85	1,33 1,32 1,43 1,42	1,03	59,60
R 108-1	108	50	28	48	SPZ SPA Z/10 A/13	79 81 73 75	94 102 93 100	1,19 1,26 1,27 1,33	1,65	63,20
R 121-1	121	55	28	48	SPZ SPA Z/10 A/13	92 94 86 88	107 115 106 113	1,16 1,22 1,23 1,28	1,75	70,20
R 138-1	138	55	38	48	SPZ SPA SPB Z/10 A/13 B/17	109 111 116 103 105 109	124 132 131 123 130 128	1,14 1,19 1,13 1,19 1,24 1,17	2,60	82,80
R 160-1	160	80	52	48	SPZ SPA SPB Z/10 A/13 B/17	119 121 126 113 115 119	134 143 153 133 141 150	1,13 1,18 1,21 1,18 1,23 1,26	4,50	101,00
R 180-1	180	80	52	48	SPA SPB A/13 B/17	141 146 135 139	163 173 161 170	1,16 1,18 1,19 1,22	5,40	128,00

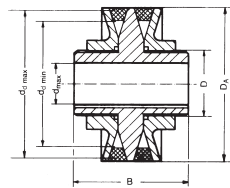
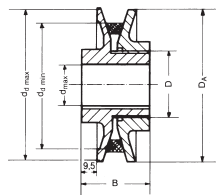

Regelscheiben für zylindrische Bohrung Variable speed pulleys for plain boring Material: GG

Bezeichnung Part Number	D _A (mm)	D (mm)	Fertigbohrung Finished bore d _{max} (mm)	B (mm)	Profil Section	d _{d min} (mm)	d _{d max} (mm)	Regel- faktor Variance factor	Gewicht Weight (= kg)	€ Stück zentriert each centered
R 083-2	83	40	26	76	SPZ Z/10	63 57	79 77	1,25 1,35	1,50	91,70
R 093-2	93	45	28	76	SPZ SPA Z/10 A/13	67 66 61 60	89 87 87 85	1,33 1,32 1,43 1,42	1,75	101,00
R 108-2	108	50	28	76	SPZ SPA Z/10 A/13	79 81 73 75	94 102 93 100	1,19 1,26 1,27 1,33	2,15	107,00
R 121-2	121	55	28	76	SPZ SPA Z/10 A/13	92 94 86 88	107 115 106 113	1,16 1,22 1,23 1,28	2,70	128,00
R 138-2	138	55	38	76	SPZ SPA SPB Z/10 A/13 B/17	109 111 116 103 105 109	124 132 131 123 130 128	1,14 1,19 1,13 1,19 1,24 1,17	4,50	139,00
R 160-2	160	80	52	90	SPZ SPA SPB Z/10 A/13 B/17	119 121 126 113 115 119	134 143 153 133 141 150	1,13 1,18 1,21 1,18 1,23 1,26	7,50	182,00
R 180-2	180	80	52	90	SPA SPB A/13 B/17	141 146 135 139	163 173 161 170	1,16 1,18 1,19 1,22	9,20	224,00

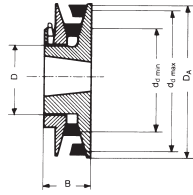

Regelscheiben für Taper-Buchsen Variable speed pulleys for taper bushes											Material: GG
Bezeichnung Part Number	D _A (mm)	D (mm)	Fertigbohrung Finished bore d _{d max} (mm)	B (mm)	Profil Section	d _{d min} (mm)	d _{d max} (mm)	Regel- faktor Variance factor	Gewicht ohne Buchse Weight without bush (= kg)	Taper- Buchse Taper bush	€ Stück ohne Buchse each without bush
TB-R 092-1	92	46	25	31	SPZ Z/10	60 55	89 88	1,48 1,60	0,85	1008	57,40
TB-R 108-1	108	50	28	35	SPZ SPA Z/10 A/13 B/17	75 76 68 70 87	93 102 92 100 97	1,24 1,34 1,35 1,43 1,11	1,20	1108	63,10
TB-R 120-1	120	55	28	35	SPZ SPA Z/10 A/13 B/17	87 88 80 82 98	105 114 104 112 108	1,20 1,29 1,30 1,36 1,10	1,50	1108	71,40
TB-R 138-1	138	65	32	38	SPZ SPA Z/10 A/13 B/17	105 106 98 100 116	123 132 122 130 126	1,17 1,24 1,24 1,30 1,09	2,20	1215	89,40
TB-R 159-1	159	75	42	39	SPZ SPA Z/10 A/13 B/17	126 128 122 128 125	144 154 152 152 148	1,14 1,20 1,24 1,18 1,18	3,50	1615	111,00
TB-R 180-1	180	75	42	45	SPZ SPA SPB Z/10 A/13 B/17	133 134 137 128 128 132	151 160 173 151 158 170	1,14 1,19 1,26 1,17 1,23 1,29	4,20	1615	139,00

Taper-Buchse Taper bush	1008	1108	1215	1615
Bohrung d ₂ (mm) von ... bis ... Bore d ₂ (mm) from ... to ...	10-25	10-28	11-32	14-42
€/Stück each	6,10	7,00	11,50	11,50

GG = Grauguss Cast iron
Fertigungstechnische Änderungen vorbehalten. We reserve the right to technical changes.
Bohrungsdurchmesser d₂ siehe Seite 3.
Bore diameters d₂ see page 3.

optibelt *RBS* Keilrippenscheiben für Taper-Buchsen, Profil PJ

Ribbed belt pulleys for taper bushes, section PJ

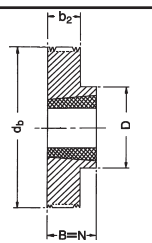

Ausf. Type 1

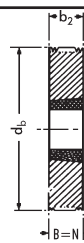

Ausf. Type 4

Bezeichnung Part Number	Anzahl der Rillen No. of ribs	Aus- führung Type	Material	d _b (mm)	b ₂ (mm)	B (mm)	N (mm)	D (mm)	Taper- Buchse Taper bush	€ Stück ohne Buchse each without bush
TB 4 PJ 47,5	4	1	GG	47,5	13	23	23	47,5	1008	46,30
TB 4 PJ 52,5	4	1	GG	52,5	13	23	23	47,5	1008	46,80
TB 4 PJ 57,5	4	1	GG	57,5	13	23	23	54,0	1108	47,20
TB 4 PJ 62,5	4	1	GG	62,5	13	23	23	54,0	1108	47,60
TB 4 PJ 67,5	4	1	GG	67,5	13	23	23	54,0	1108	47,90
TB 4 PJ 72,5	4	1	GG	72,5	13	23	23	54,0	1108	48,60
TB 4 PJ 77,5	4	1	GG	77,5	13	26	26	70,0	1210	49,40
TB 4 PJ 82,5	4	1	GG	82,5	13	26	26	78,0	1210	50,10
TB 4 PJ 87,5	4	1	GG	87,5	13	26	26	78,0	1210	50,70
TB 4 PJ 92,5	4	1	GG	92,5	13	26	26	78,0	1210	51,80
TB 4 PJ 97,5	4	1	GG	97,5	13	26	26	78,0	1210	52,30
TB 4 PJ 102,5	4	1	GG	102,5	13	26	26	85,0	1610	57,40
TB 4 PJ 107,5	4	1	GG	107,5	13	26	26	85,0	1610	66,10
TB 4 PJ 112,5	4	1	GG	112,5	13	26	26	85,0	1610	67,30
TB 4 PJ 117,5	4	1	GG	117,5	13	26	26	85,0	1610	67,80
TB 4 PJ 122,5	4	1	GG	122,5	13	26	26	85,0	1610	68,90
TB 4 PJ 127,5	4	1	GG	127,5	13	26	26	85,0	1610	69,40
TB 4 PJ 137,5	4	1	GG	137,5	13	26	26	85,0	1610	71,70
TB 4 PJ 152,5	4	1	GG	152,5	13	26	26	85,0	1610	75,00
TB 4 PJ 162,5	4	1	GG	162,5	13	26	26	85,0	1610	77,20
TB 4 PJ 172,5	4	1	GG	172,5	13	26	26	85,0	1610	79,90
TB 4 PJ 182,5	4	1	GG	182,5	13	26	26	85,0	1610	82,70
TB 4 PJ 192,5	4	1	GG	192,5	13	26	26	85,0	1610	85,00
TB 4 PJ 202,5	4	1	GG	202,5	13	33	33	100,0	2012	95,40
TB 4 PJ 222,5	4	1	GG	222,5	13	33	33	100,0	2012	101,00
TB 8 PJ 47,5	8	4	GG	47,5	23	23	23	—	1008	47,30
TB 8 PJ 52,5	8	4	GG	52,5	23	23	23	—	1008	47,70
TB 8 PJ 57,5	8	4	GG	57,5	23	23	23	—	1108	48,00
TB 8 PJ 62,5	8	4	GG	62,5	23	23	23	—	1108	48,60
TB 8 PJ 67,5	8	4	GG	67,5	23	23	23	—	1108	48,90
TB 8 PJ 72,5	8	4	GG	72,5	23	23	23	—	1108	49,70
TB 8 PJ 77,5	8	1	GG	77,5	23	26	26	70,0	1210	50,50
TB 8 PJ 82,5	8	1	GG	82,5	23	26	26	78,0	1210	51,20
TB 8 PJ 87,5	8	1	GG	87,5	23	26	26	78,0	1210	51,70
TB 8 PJ 92,5	8	1	GG	92,5	23	26	26	78,0	1210	53,00
TB 8 PJ 97,5	8	1	GG	97,5	23	26	26	78,0	1210	53,50
TB 8 PJ 102,5	8	1	GG	102,5	23	26	26	85,0	1610	58,40
TB 8 PJ 107,5	8	1	GG	107,5	23	26	26	85,0	1610	67,80
TB 8 PJ 112,5	8	1	GG	112,5	23	26	26	85,0	1610	68,40
TB 8 PJ 117,5	8	1	GG	117,5	23	26	26	85,0	1610	69,40
TB 8 PJ 122,5	8	1	GG	122,5	23	26	26	85,0	1610	70,00
TB 8 PJ 127,5	8	1	GG	127,5	23	26	26	85,0	1610	71,20
TB 8 PJ 137,5	8	1	GG	137,5	23	26	26	85,0	1610	73,30
TB 8 PJ 152,5	8	1	GG	152,5	23	26	26	85,0	1610	76,60
TB 8 PJ 162,5	8	1	GG	162,5	23	26	26	85,0	1610	80,50
TB 8 PJ 172,5	8	1	GG	172,5	23	26	26	85,0	1610	83,80
TB 8 PJ 182,5	8	1	GG	182,5	23	26	26	85,0	1610	86,60
TB 8 PJ 192,5	8	1	GG	192,5	23	26	26	85,0	1610	89,40
TB 8 PJ 202,5	8	1	GG	202,5	23	33	33	100,0	2012	99,80
TB 8 PJ 222,5	8	1	GG	222,5	23	33	33	100,0	2012	106,00

Taper-Buchse Taper bush	1008	1108	1210	1610	2012
Bohrung d ₂ (mm) von ... bis ... Bore d ₂ (mm) from ... to ...	10-25	10-28	11-32	14-42	14-50
€/Stück each	6,10	7,00	9,20	11,00	13,50

GG = Grauguss Cast iron
 Weitere Abmessungen auf Anfrage.
 Further sizes on request.
 Fertigungstechnische Änderungen vorbehalten.
 We reserve the right to make technical changes.
 Bohrungsdurchmesser d₂ siehe Seite 3.
 Bore diameters d₂ see page 3.

optibelt *RBS* Keilrippenscheiben für Taper-Buchsen, Profil PJ
Ribbed belt pulleys for taper bushes, section PJ

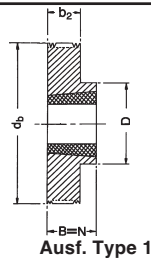

Ausf. Type 1

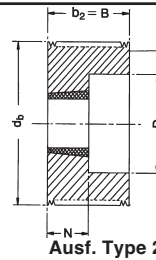

Ausf. Type 2

Bezeichnung Part Number	Anzahl der Rillen No. of ribs	Aus- führung Type	Material	d _b (mm)	b ₂ (mm)	B (mm)	N (mm)	D (mm)	Taper- Buchse Taper bush	€ Stück ohne Buchse each without bush
TB 12 PJ 62,5	12	2	GG	62,5	32	32	23	50,0	1108	49,50
TB 12 PJ 67,5	12	2	GG	67,5	32	32	23	50,0	1108	50,00
TB 12 PJ 72,5	12	2	GG	72,5	32	32	23	50,0	1108	50,70
TB 12 PJ 77,5	12	2	GG	77,5	32	32	26	62,0	1210	51,60
TB 12 PJ 82,5	12	2	GG	82,5	32	32	26	62,0	1210	52,20
TB 12 PJ 87,5	12	2	GG	87,5	32	32	26	70,0	1610	57,40
TB 12 PJ 92,5	12	2	GG	92,5	32	32	26	70,0	1610	58,40
TB 12 PJ 97,5	12	2	GG	97,5	32	32	26	70,0	1610	59,00
TB 12 PJ 102,5	12	2	GG	102,5	32	32	26	70,0	1610	60,10
TB 12 PJ 107,5	12	2	GG	107,5	32	32	26	70,0	1610	68,90
TB 12 PJ 112,5	12	2	GG	112,5	32	32	26	70,0	1610	70,00
TB 12 PJ 117,5	12	2	GG	117,5	32	32	26	70,0	1610	71,20
TB 12 PJ 122,5	12	2	GG	122,5	32	32	26	70,0	1610	71,70
TB 12 PJ 127,5	12	1	GG	127,5	32	32	33	100,0	2012	79,90
TB 12 PJ 137,5	12	1	GG	137,5	32	32	33	100,0	2012	82,20
TB 12 PJ 152,5	12	1	GG	152,5	32	32	33	100,0	2012	85,50
TB 12 PJ 162,5	12	1	GG	162,5	32	32	33	100,0	2012	89,90
TB 12 PJ 172,5	12	1	GG	172,5	32	32	33	100,0	2012	92,70
TB 12 PJ 182,5	12	1	GG	182,5	32	46	46	110,0	2517	103,00
TB 12 PJ 192,5	12	1	GG	192,5	32	46	46	110,0	2517	106,00
TB 12 PJ 202,5	12	1	GG	202,5	32	46	46	110,0	2517	110,00
TB 12 PJ 222,5	12	1	GG	222,5	32	46	46	110,0	2517	117,00
TB 16 PJ 62,5	16	2	GG	62,5	41	41	23	50,0	1108	50,90
TB 16 PJ 67,5	16	2	GG	67,5	41	41	23	50,0	1108	51,40
TB 16 PJ 72,5	16	2	GG	72,5	41	41	26	62,0	1210	52,10
TB 16 PJ 77,5	16	2	GG	77,5	41	41	26	62,0	1210	52,80
TB 16 PJ 82,5	16	2	GG	82,5	41	41	26	62,0	1210	53,40
TB 16 PJ 87,5	16	2	GG	87,5	41	41	26	70,0	1610	58,40
TB 16 PJ 92,5	16	2	GG	92,5	41	41	26	70,0	1610	59,60
TB 16 PJ 97,5	16	2	GG	97,5	41	41	26	70,0	1610	60,10
TB 16 PJ 102,5	16	2	GG	102,5	41	41	26	70,0	1610	61,20
TB 16 PJ 107,5	16	2	GG	107,5	41	41	26	70,0	1610	77,80
TB 16 PJ 112,5	16	2	GG	112,5	41	41	33	85,0	2012	78,90
TB 16 PJ 117,5	16	2	GG	117,5	41	41	33	85,0	2012	79,40
TB 16 PJ 122,5	16	2	GG	122,5	41	41	33	85,0	2012	80,50
TB 16 PJ 127,5	16	2	GG	127,5	41	41	33	85,0	2012	81,60
TB 16 PJ 137,5	16	2	GG	137,5	41	41	33	85,0	2012	83,80
TB 16 PJ 152,5	16	2	GG	152,5	41	41	33	85,0	2012	87,60
TB 16 PJ 162,5	16	2	GG	162,5	41	41	33	85,0	2012	93,70
TB 16 PJ 172,5	16	2	GG	172,5	41	41	33	85,0	2012	97,10
TB 16 PJ 182,5	16	1	GG	182,5	41	46	46	110,0	2517	108,00
TB 16 PJ 192,5	16	1	GG	192,5	41	46	46	110,0	2517	111,00
TB 16 PJ 202,5	16	1	GG	202,5	41	46	46	110,0	2517	114,00
TB 16 PJ 222,5	16	1	GG	222,5	41	46	46	110,0	2517	122,00

Taper-Buchse Taper bush	1108	1210	1610	2012	2517
Bohrung d ₂ (mm) von ... bis ... Bore d ₂ (mm) from ... to ...	10-28	11-32	14-42	14-50	16-60
€/Stück each	7,00	9,20	11,00	13,50	16,90

GG = Grauguss Cast iron
 Weitere Abmessungen auf Anfrage.
 Further sizes on request.
 Fertigungstechnische Änderungen vorbehalten.
 We reserve the right to make technical changes.
 Bohrungsdurchmesser d₂ siehe Seite 3.
 Bore diameters d₂ see page 3.

optibelt RB5 Keilrippenscheiben für Taper-Buchsen, Profil PL (keine Lagerware)
Ribbed belt pulleys for taper bushes, section PL (non stock items)

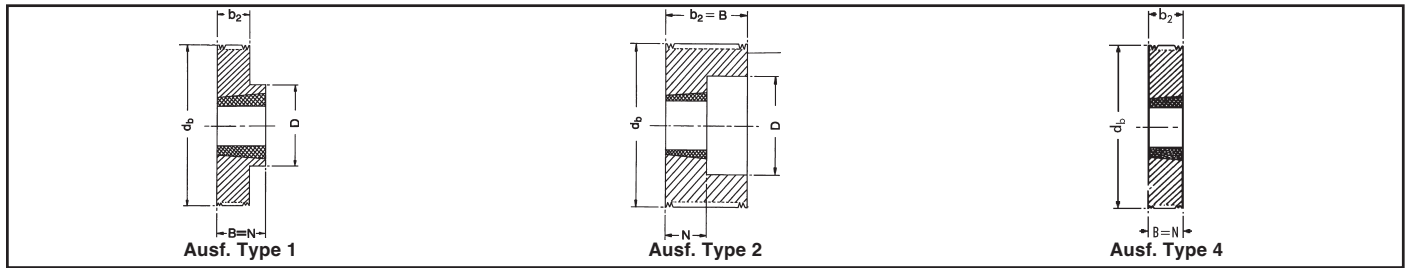

Bezeichnung Part Number	Anzahl der Rillen No. of ribs	Aus- führung Type	Material	d _b (mm)	b ₂ (mm)	B (mm)	N (mm)	D (mm)	Taper- Buchse Taper bush	€ Stück ohne Buchse each without bush
TB 6 PL 78	6	2	GG	78	33	33	26	62,0	1210	59,00
TB 6 PL 83	6	2	GG	83	33	33	26	62,0	1210	64,50
TB 6 PL 88	6	2	GG	88	33	33	26	70,0	1610	65,60
TB 6 PL 93	6	2	GG	93	33	33	26	70,0	1610	66,80
TB 6 PL 98	6	2	GG	98	33	33	26	70,0	1610	67,30
TB 6 PL 103	6	2	GG	103	33	33	26	70,0	1610	78,90
TB 6 PL 108	6	2	GG	108	33	33	26	70,0	1610	79,90
TB 6 PL 113	6	2	GG	113	33	33	26	70,0	1610	80,50
TB 6 PL 118	6	2	GG	118	33	33	26	70,0	1610	81,60
TB 6 PL 123	6	4	GG	123	33	33	33	—	2012	90,40
TB 6 PL 133	6	4	GG	133	33	33	33	—	2012	92,70
TB 6 PL 148	6	4	GG	148	33	33	33	—	2012	97,10
TB 6 PL 158	6	4	GG	158	33	33	33	—	2012	102,00
TB 6 PL 168	6	4	GG	168	33	33	33	—	2012	106,00
TB 6 PL 178	6	1	GG	178	33	46	46	110,0	2517	117,00
TB 6 PL 188	6	1	GG	188	33	46	46	110,0	2517	120,00
TB 6 PL 198	6	1	GG	198	33	46	46	110,0	2517	124,00
TB 6 PL 218	6	1	GG	218	33	46	46	110,0	2517	133,00
TB 6 PL 238	6	1	GG	238	33	46	46	110,0	2517	261,00
TB 6 PL 258	6	1	GG	258	33	46	46	110,0	2517	273,00
TB 6 PL 278	6	1	GG	278	33	46	46	110,0	2517	285,00
TB 6 PL 298	6	1	GG	298	33	46	46	110,0	2517	299,00
TB 6 PL 318	6	1	GG	318	33	46	46	110,0	2517	331,00
TB 6 PL 348	6	1	GG	348	33	46	46	110,0	2517	356,00
TB 6 PL 388	6	1	GG	388	33	46	46	110,0	2517	398,00
TB 8 PL 78	8	2	GG	78	42	42	26	62,0	1210	62,30
TB 8 PL 83	8	2	GG	83	42	42	26	62,0	1210	62,80
TB 8 PL 88	8	2	GG	88	42	42	26	70,0	1610	68,90
TB 8 PL 93	8	2	GG	93	42	42	26	70,0	1610	70,00
TB 8 PL 98	8	2	GG	98	42	42	26	70,0	1610	70,60
TB 8 PL 103	8	2	GG	103	42	42	33	85,0	2012	89,90
TB 8 PL 108	8	2	GG	108	42	42	33	85,0	2012	91,50
TB 8 PL 113	8	2	GG	113	42	42	33	85,0	2012	92,10
TB 8 PL 118	8	2	GG	118	42	42	33	85,0	2012	93,70
TB 8 PL 123	8	2	GG	123	42	42	33	85,0	2012	94,80
TB 8 PL 133	8	2	GG	133	42	42	33	85,0	2012	97,60
TB 8 PL 148	8	2	GG	148	42	42	33	85,0	2012	102,00
TB 8 PL 158	8	2	GG	158	42	42	33	85,0	2012	108,00
TB 8 PL 168	8	2	GG	168	42	42	33	85,0	2012	112,00
TB 8 PL 178	8	1	GG	178	42	46	46	110,0	2517	123,00
TB 8 PL 188	8	1	GG	188	42	46	46	110,0	2517	127,00
TB 8 PL 198	8	1	GG	198	42	46	46	110,0	2517	132,00
TB 8 PL 218	8	1	GG	218	42	46	46	110,0	2517	140,00
TB 8 PL 238	8	1	GG	238	42	46	46	110,0	2517	279,00
TB 8 PL 258	8	1	GG	258	42	46	46	110,0	2517	291,00
TB 8 PL 278	8	1	GG	278	42	46	46	110,0	2517	304,00
TB 8 PL 298	8	1	GG	298	42	46	46	110,0	2517	320,00
TB 8 PL 318	8	1	GG	318	42	46	46	110,0	2517	353,00
TB 8 PL 348	8	1	GG	348	42	46	46	110,0	2517	382,00
TB 8 PL 388	8	1	GG	388	42	46	46	110,0	2517	427,00

Taper-Buchse Taper bush	1210	1610	2012	2517
Bohrung d ₂ (mm) von ... bis ... Bore d ₂ (mm) from ... to ...	11-32	14-42	14-50	16-60
€/Stück each	9,20	11,00	13,50	16,90

GG = Grauguss Cast iron
 Weitere Abmessungen auf Anfrage.
 Further sizes on request.
 Fertigungstechnische Änderungen vorbehalten.
 We reserve the right to make technical changes.
 Bohrungsdurchmesser d₂ siehe Seite 3.
 Bore diameters d₂ see page 3.

optibelt RBS Keilrippenscheiben für Taper-Buchsen, Profil PL (keine Lagerware)
Ribbed belt pulleys for taper bushes, section PL (non stock items)

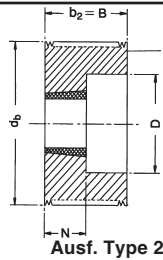

Ausf. Type 2

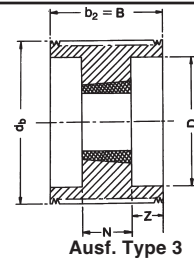

Ausf. Type 3

Bezeichnung Part Number	Anzahl der Rillen No. of ribs	Aus- führung Type	Material	d_b (mm)	b_2 (mm)	B (mm)	N (mm)	D (mm)	Taper- Buchse Taper bush	€ Stück ohne Buchse each without bush
TB 10 PL 88	10	3	GG	88	53	53	26	70,0	1610	90,40
TB 10 PL 93	10	3	GG	93	53	53	26	70,0	1610	91,50
TB 10 PL 98	10	3	GG	98	53	53	26	70,0	1610	92,70
TB 10 PL 103	10	2	GG	103	53	53	33	85,0	2012	118,00
TB 10 PL 108	10	2	GG	108	53	53	33	85,0	2012	120,00
TB 10 PL 113	10	2	GG	113	53	53	33	85,0	2012	121,00
TB 10 PL 118	10	2	GG	118	53	53	33	85,0	2012	123,00
TB 10 PL 123	10	2	GG	123	53	53	33	85,0	2012	125,00
TB 10 PL 133	10	2	GG	133	53	53	33	85,0	2012	128,00
TB 10 PL 148	10	2	GG	148	53	53	33	85,0	2012	135,00
TB 10 PL 158	10	2	GG	158	53	53	33	85,0	2012	141,00
TB 10 PL 168	10	2	GG	168	53	53	33	85,0	2012	148,00
TB 10 PL 178	10	2	GG	178	53	53	46	105,0	2517	162,00
TB 10 PL 188	10	2	GG	188	53	53	46	105,0	2517	167,00
TB 10 PL 198	10	2	GG	198	53	53	46	105,0	2517	172,00
TB 10 PL 218	10	2	GG	218	53	53	46	105,0	2517	185,00
TB 10 PL 238	10	2	GG	238	53	53	46	105,0	2517	296,00
TB 10 PL 258	10	2	GG	258	53	53	46	105,0	2517	310,00
TB 10 PL 278	10	2	GG	278	53	53	46	105,0	2517	324,00
TB 10 PL 298	10	2	GG	298	53	53	46	105,0	2517	341,00
TB 10 PL 318	10	2	GG	318	53	53	46	105,0	2517	378,00
TB 10 PL 348	10	2	GG	348	53	53	46	105,0	2517	408,00
TB 10 PL 388	10	2	GG	388	53	53	46	105,0	2517	456,00
TB 12 PL 88	12	3	GG	88	62	62	26	70,0	1610	92,70
TB 12 PL 93	12	3	GG	93	62	62	26	70,0	1610	94,30
TB 12 PL 98	12	3	GG	98	62	62	26	70,0	1610	95,40
TB 12 PL 103	12	3	GG	103	62	62	33	85,0	2012	121,00
TB 12 PL 108	12	3	GG	108	62	62	33	85,0	2012	122,00
TB 12 PL 113	12	3	GG	113	62	62	33	85,0	2012	124,00
TB 12 PL 118	12	3	GG	118	62	62	33	85,0	2012	126,00
TB 12 PL 123	12	3	GG	123	62	62	33	85,0	2012	128,00
TB 12 PL 133	12	3	GG	133	62	62	33	85,0	2012	132,00
TB 12 PL 148	12	2	GG	148	62	62	46	105,0	2517	148,00
TB 12 PL 158	12	2	GG	158	62	62	46	105,0	2517	154,00
TB 12 PL 168	12	2	GG	168	62	62	46	105,0	2517	161,00
TB 12 PL 178	12	2	GG	178	62	62	46	105,0	2517	166,00
TB 12 PL 188	12	2	GG	188	62	62	46	105,0	2517	171,00
TB 12 PL 198	12	2	GG	198	62	62	46	105,0	2517	177,00
TB 12 PL 218	12	2	GG	218	62	62	46	105,0	2517	189,00
TB 12 PL 238	12	2	GG	238	62	62	52	130,0	3020	401,00
TB 12 PL 258	12	2	GG	258	62	62	52	130,0	3020	495,00
TB 12 PL 278	12	2	GG	278	62	62	52	130,0	3020	510,00
TB 12 PL 298	12	2	GG	298	62	62	52	130,0	3020	528,00
TB 12 PL 318	12	2	GG	318	62	62	52	130,0	3020	565,00
TB 12 PL 348	12	2	GG	348	62	62	52	130,0	3020	597,00
TB 12 PL 388	12	2	GG	388	62	62	52	130,0	3020	646,00

Taper-Buchse Taper bush	1610	2012	2517	3020
Bohrung d_2 (mm) von ... bis ... Bore d_2 (mm) from ... to ...	14-42	14-50	16-60	25-75
€/Stück each	11,00	13,50	16,90	22,00

GG = Grauguss Cast iron
 Weitere Abmessungen auf Anfrage.
 Further sizes on request.
 Fertigungstechnische Änderungen vorbehalten.
 We reserve the right to make technical changes.
 Bohrungsdurchmesser d_2 siehe Seite 3.
 Bore diameters d_2 see page 3.

optibelt RBS Keilrippenscheiben für Taper-Buchsen, Profil PL (keine Lagerware)
Ribbed belt pulleys for taper bushes, section PL (non stock items)

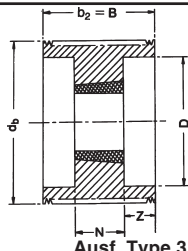

Ausf. Type 3

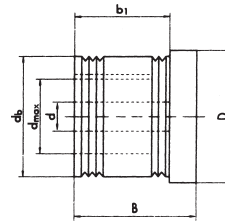

Ausf. Type VB (für zyl. Bohrung for plain boring)

Bezeichnung Part Number	Anzahl der Rillen No. of ribs	Aus- führung Type	Material	d_b (mm)	b_2 (mm)	B (mm)	N (mm)	D (mm)	Taper- Buchse Taper bush	€ Stück ohne Buchse each without bush
TB 16 PL 103	16	3	GG	103	80	80	33	85,0	2012	125,00
TB 16 PL 108	16	3	GG	108	80	80	33	85,0	2012	127,00
TB 16 PL 113	16	3	GG	113	80	80	33	85,0	2012	128,00
TB 16 PL 118	16	3	GG	118	80	80	33	85,0	2012	131,00
TB 16 PL 123	16	3	GG	123	80	80	33	85,0	2012	133,00
TB 16 PL 133	16	3	GG	133	80	80	33	85,0	2012	136,00
TB 16 PL 148	16	3	GG	148	80	80	46	105,0	2517	152,00
TB 16 PL 158	16	3	GG	158	80	80	46	105,0	2517	164,00
TB 16 PL 168	16	3	GG	168	80	80	46	105,0	2517	170,00
TB 16 PL 178	16	3	GG	178	80	80	46	105,0	2517	175,00
TB 16 PL 188	16	3	GG	188	80	80	46	105,0	2517	182,00
TB 16 PL 198	16	3	GG	198	80	80	46	105,0	2517	187,00
TB 16 PL 218	16	3	GG	218	80	80	46	105,0	2517	201,00
TB 16 PL 238	16	3	GG	238	80	80	52	130,0	3020	416,00
TB 16 PL 258	16	3	GG	258	80	80	52	130,0	3020	428,00
TB 16 PL 278	16	3	GG	278	80	80	52	130,0	3020	441,00
TB 16 PL 298	16	3	GG	298	80	80	52	130,0	3020	457,00
TB 16 PL 318	16	3	GG	318	80	80	52	130,0	3020	490,00
TB 16 PL 348	16	3	GG	348	80	80	52	130,0	3020	518,00
TB 16 PL 388	16	3	GG	388	80	80	52	130,0	3020	562,00

Taper-Buchse Taper bush	2012	2517	3020
Bohrung d_2 (mm) von ... bis ... Bore d_2 (mm) from ... to ...	14-50	16-60	25-75
€/Stück each	13,50	16,90	22,00

Bohrungsdurchmesser d_2 siehe Seite 3.
Bore diameters d_2 see page 3.

optibelt RBS Keilrippenscheiben mit zylindrischer Bohrung, Profil PJ
Ribbed belt pulleys for plain boring, section PJ

Bezeichnung Part Number	Anzahl der Rillen No. of ribs	Aus- führung Type	Material	d_b (mm)	b_1 (mm)	B (mm)	D (mm)	Vorbereitung Pilot bore d (mm)	Fertig- bohrung Finish bore d_{max} (mm)	Gewicht Weight (≈ kg)	€ Stück each
4 PJ 22,5	4	VB	GG	22,5	13	20	25	8	12,0	0,045	18,20
4 PJ 27,5	4	VB	GG	27,5	13	20	30	8	14,0	0,070	19,30
4 PJ 32,5	4	VB	GG	32,5	13	20	35	8	18,0	0,100	20,40
4 PJ 37,5	4	VB	GG	37,5	13	20	40	8	20,0	0,135	21,50
4 PJ 42,5	4	VB	GG	42,5	13	20	45	8	22,0	0,180	23,80
8 PJ 22,5	8	VB	GG	22,5	23	30	25	8	12,0	0,063	19,30
8 PJ 27,5	8	VB	GG	27,5	23	30	30	8	14,0	0,100	20,40
8 PJ 32,5	8	VB	GG	32,5	23	30	35	8	18,0	0,150	22,00
8 PJ 37,5	8	VB	GG	37,5	23	30	40	8	20,0	0,200	24,30
8 PJ 42,5	8	VB	GG	42,5	23	30	45	8	22,0	0,265	26,40
12 PJ 22,5	12	VB	GG	22,5	32	40	25	8	12,0	0,086	21,00
12 PJ 27,5	12	VB	GG	27,5	32	40	30	8	14,0	0,140	22,60
12 PJ 32,5	12	VB	GG	32,5	32	40	35	8	18,0	0,200	24,30
12 PJ 37,5	12	VB	GG	37,5	32	40	40	8	20,0	0,280	25,90
12 PJ 42,5	12	VB	GG	42,5	32	40	45	8	22,0	0,360	28,70

GG = Grauguss Cast iron

Weitere Abmessungen auf Anfrage. Further sizes on request.

Fertigungstechnische Änderungen vorbehalten. We reserve the right to make technical changes.



Außendurchmesser x Breite Outside diameter x width (mm)	Taper-Buchse Taper bush	€ Stück ohne Buchse each without bush	Außendurchmesser x Breite Outside diameter x width (mm)	Taper-Buchse Taper bush	€ Stück ohne Buchse each without bush
63 x 50	1108	42,30	224 x 50	2517	112,00
80 x 50	1210	47,60	224 x 80	2517	169,00
80 x 80	1615	58,40	224 x 100	3020	195,00
90 x 50	1615	63,00	224 x 125	3030	223,00
90 x 80	1615	66,00	224 x 160	3030	258,00
90 x 100	1615	75,30	250 x 80	2517	187,00
100 x 50	1615	69,90	250 x 100	3020	216,00
100 x 80	1615	79,90	250 x 125	3030	253,00
100 x 100	1615	92,10	250 x 160	3030	292,00
125 x 50	2012	82,20	280 x 100	3020	245,00
125 x 80	2517	98,30	280 x 125	3030	287,00
125 x 100	2517	113,00	280 x 160	3535	337,00
125 x 125	2517	118,00	280 x 200	4040	399,00
140 x 50	2012	94,50	315 x 100	3020	272,00
140 x 80	2517	105,00	315 x 125	3030	343,00
140 x 100	3020	125,00	315 x 160	3535	391,00
140 x 125	3030	132,00	315 x 200	4040	467,00
150 x 50	2012	99,80	355 x 100	3030	314,00
150 x 80	2517	113,00	355 x 125	3030	382,00
150 x 100	3020	133,00	355 x 160	3535	456,00
150 x 125	3030	138,00	355 x 200	4040	539,00
150 x 160	3030	154,00	400 x 100	3535	402,00
160 x 50	2012	105,00	400 x 125	3535	456,00
160 x 80	2517	121,00	400 x 160	3535	528,00
160 x 100	3020	140,00	400 x 200	4040	624,00
160 x 125	3030	143,00	450 x 160	3535	614,00
160 x 160	3030	171,00	450 x 200	4040	725,00
180 x 80	2517	136,00	500 x 160	4040	701,00
180 x 100	3020	158,00	500 x 200	4545	826,00
180 x 125	3030	168,00	560 x 160	4040	872,00
180 x 160	3030	198,00	560 x 200	4545	1.012,00
200 x 80	2517	150,00	630 x 160	4545	953,00
200 x 100	3020	173,00	630 x 200	5050	1.124,00
200 x 125	3030	194,00			
200 x 160	3030	223,00			

Taper-Buchse Taper bush	1108	1210	1615	2012	2517	3020	3030	3535	4040	4545	5050
Bohrung d ₂ (mm) von ... bis ... Bore d ₂ (mm) from ... to ...	10-28	11-32	14-42	14-50	16-60	25-75	35-75	35-90	40-100	55-110	70-125
€/Stück each	7,00	9,20	11,50	13,50	16,90	22,00	28,80	55,50	78,00	99,30	159,00

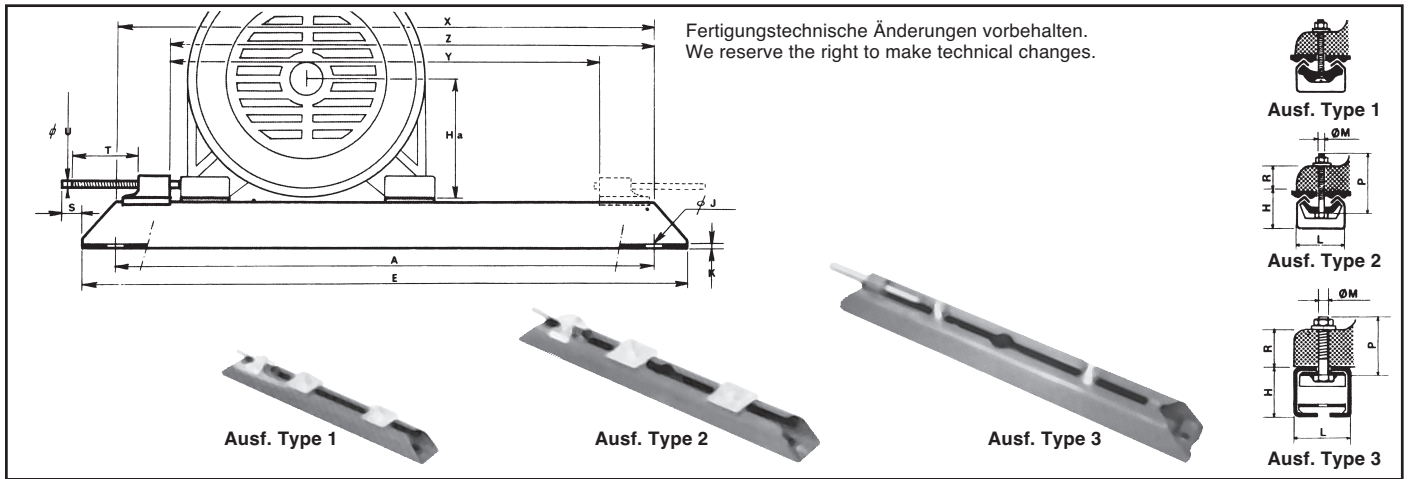

Bezeichnung Part number	S71/6VS	N300/6VS	S100/8VS	N400/8VS	S132/10VS	N600/10VS	S180/12VS	S225/16GS	S280/20GS	S355/24GS
Ausführung Type	1	1	2	2	2	2	2	3	3	3
Motorachshöhe Motor shaft centre height Ha (mm)	56/63/71	80	80/90/100	100/112	100/112/132	160	160/180	200/225	250/280	315/355
Abmessungen Dimensions	A (mm)	280,0	343,0	355,0	455,0	480,0	580,0	630,0	800,0	1000,0
	E (mm)	312,0	375,0	395,0	495,0	530,0	630,0	686,0	864,0	1072,0
	H (mm)	28,0	28,0	40,0	40,0	49,5	49,5	60,5	75,0	100,0
	Ø J (mm)	10,5	10,5	13,0	13,0	15,0	15,0	19,0	24,0	30,0
	K (mm)	1,5	1,5	2,5	2,5	7,0	7,0	7,0	28,5	35,0
	L (mm)	40,2	40,2	50,0	50,0	60,0	60,0	75,0	90,0	112,0
	Ø M (mm)	6,0	6,0	8,0	8,0	10,0	10,0	12,0	16,0	20,0
	P (mm)	35,0	35,0	45,0	45,0	55,0	55,0	70,0	70,0	80,0
	R (mm)	13,0	13,0	18,5	18,5	23,5	23,5	34,0	41,0	48,0
	S (mm)	20,0	20,0	30,0	32,0	37,0	37,0	50,0	167,0	200,0
	T (mm)	75,0	75,0	97,0	97,0	119,0	119,0	154,0	300,0	360,0
□ U (mm)	6,0	6,0	8,0	8,0	9,0	9,0	12,0	16,0	19,0	
Nutzlänge Working length	X (mm)	262,0	325,0	324,0	424,0	442,0	542,0	—	—	—
	Y (mm)	206,0	265,0	264,0	354,0	368,0	473,0	623,0	764,0	946,0
	Z (mm)	234,0	295,0	294,0	394,0	405,0	502,5	698,0	864,0	1064,0
Gewicht je Paar Weight per pair (= kg)	1,120	1,300	2,970	3,500	6,100	6,500	10,650	16,200	36,100	59,500
€/Satz set	67,80	83,40	97,10	113,00	144,00	157,00	225,00	479,00	758,00	1.129,00

Vorteile der Optibelt MS Motorspannschienen

- Sie sind unzerbrechlich, weil sie ganz aus Stahl hergestellt sind.
- Die genormten Motorbefestigungsschrauben sind leicht auswechselbar, z. B. bei starken Motorfüßen oder bei zu befestigenden Zusatzteilen.
- Leichtes Aufsetzen des Motors:
Nach dem Einstecken der Motorbefestigungsschrauben in die Motorfüße wird das Ganze mit den Spezialmuttern in die Stahlspannschienen eingeschoben.
- Alle Einzelteile sind bestens gegen Korrosion durch entsprechende Oberflächenbehandlung geschützt.
- Stahlspannschienen: phosphatiert und grün einbrennlackiert.
- Spannschrauben: elektro-verzinkt.
- Motorbefestigungsschrauben:
für S 71 bis S 180 elektro-verzinkt,
für S 225 bis S 355 phosphatiert und mit Rostschutz versehen.

Die mit „S“ gekennzeichneten Abmessungen (z. B. S 71) entsprechen der französischen Norm U.T.E. C-51106.
Die Zahlen 71, 100, 132, 180, 225, 280 und 355 bezeichnen die maximalen Motorachshöhen in mm für den jeweiligen Spannschienen-Typ.
Die Zahlen hinter dem Schrägstrich (6, 8, 10, 12, 16, 20, 24) geben den Gewindedurchmesser der entsprechenden Befestigungsschrauben an (6 = M6).
Die Buchstaben VS bzw. GS bezeichnen die Ausführung der Spannkloben:
VS = verschiebbarer Spannkloben
GS = geschweißter Spannkloben

Die Typen N 300, N 400 und N 600 sind nicht genormt. Es handelt sich jeweils um die verlängerte Ausführung der genormten Schiene, sodass hierfür die gleichen Ersatzteile verwendet werden können.
Ein Satz Spannschienen besteht aus 2 Schienen inklusive aller Befestigungsteile.

Advantages of Optibelt MS Motor slide rails

- Rugged all steel construction.
- The standard motor fixing bolts are easily replaced, e. g. for heavier motor feet or for the mounting of auxiliary equipment.
- Easy motor mounting. After inserting the motor mounting bolts into the motor feet, the whole unit is pushed into the rails.
- All parts are fully corrosion protected.
- The adjusting bolts are zinc plated.
- The motor mounting bolts:
for S 71 up to S 180 are zinc plated,
for S 225 up to S 355 are phosphated and rust protected.

The sizes marked with "S" (e. g. S 71) correspond to the French standard U.T.E. C-51106.

The numbers 71, 100, 132, 180, 225, 280, and 355 indicate the max. motor shaft height in mm for the individual rail types.

The numbers following the slash (6, 8, 10, 12, 16, 20, 24) indicate the thread diameters of the fixing bolts (6 = M6).

The letters VS and GS indicate the design of the adjusting screw bracket:

VS = sliding bracket

GS = fixed bracket

Slide rail part number N 300, N 400, and N 600 are not standardised. They are longer than the standard slide rails but all of the same spare parts can be used.

One set of slide rails consists of 2 rails with all fixing parts.

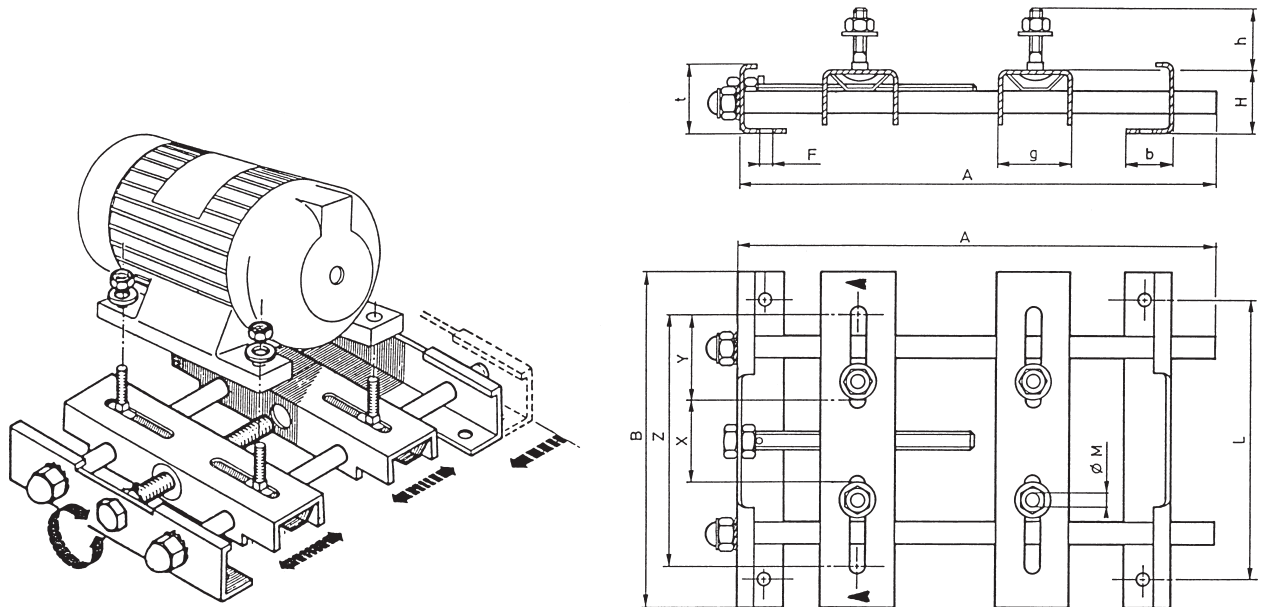

Fertigungstechnische Änderungen vorbehalten. We reserve the right to make technical changes.

Bezeichnung Part number	MS 100	MS 132
Motorachshöhe Motor shaft height Ha (mm)	100,0	132,0
A (mm)	300,0	450,0
B (mm)	180,0	265,0
F (mm)	10,0	13,0
H (mm)	35,0	50,0
L (mm)	150,0	225,0
M	M 8 x 35	M 10 x 40
b (mm)	30,0	45,0
g (mm)	40,0	55,0
h (mm)	35,0	40,0
t (mm)	40,0	55,0
u (mm)	25,0	35,0
v (mm)	20,0	25,0
w (mm)	9,0	18,0
x (mm)	46,0	105,0
y (mm)	50,0	50,0
z (mm)	145,0	204,0
Gewicht Weight (≈ kg)	2,180	4,520
€/Stück each	107,00	171,00

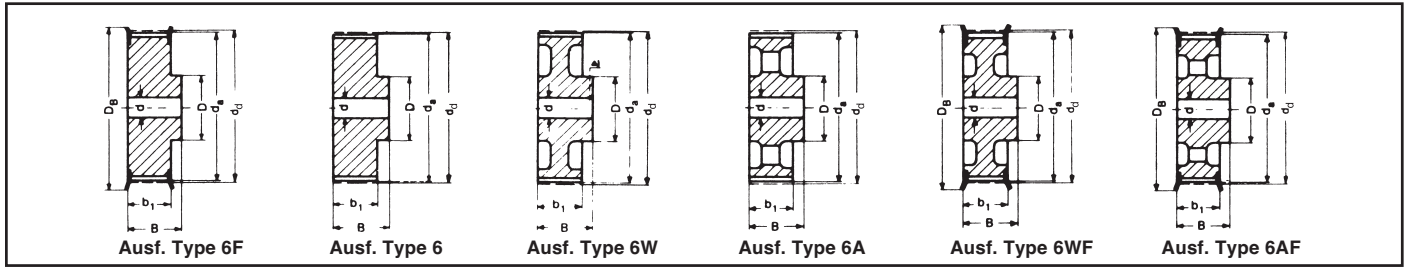

Type XL – Teilung Pitch 5,08 mm für Riemenbreite for belt width 025, 031, 037

Bezeichnung Part No.	Anzahl der Zähne No. of teeth	Aus- führung Type	Material	d _d (mm)	d _a (mm)	D _B (mm)	b ₁ (mm)	B (mm)	D (mm)	Vor- bohrung Pilot bore d (mm)	Fertig- bohrung Finished bore d _{max} (mm)	Stell- schraube Grub screw	Gewicht Weight (= kg)	€ Stück each
10 XL 037	10	6F	St	16,17	15,66	23	14,3	19,8	9,5	5,0	6,4	M3	0,02	8,70
11 XL 037	11	6F	St	17,79	17,28	23	14,3	19,8	9,5	5,0	6,4	M3	0,02	9,00
12 XL 037	12	6F	St	19,40	18,89	25	14,3	19,8	12,7	5,0	7,9	M3	0,03	9,30
14 XL 037	14	6F	St	22,64	22,13	28	14,3	19,8	14,3	6,0	9,5	M4	0,04	9,60
15 XL 037	15	6F	St	24,26	23,75	28	14,3	19,8	15,9	6,0	11,1	M4	0,04	10,00
16 XL 037	16	6F	St	25,87	25,36	32	14,3	19,8	17,5	6,0	12,7	M4	0,05	10,30
18 XL 037	18	6F	St	29,11	28,60	36	14,3	19,8	19,0	6,0	14,3	M4	0,06	10,60
20 XL 037	20	6F	St	32,34	31,83	38	14,3	22,2	23,8	6,0	17,5	M4	0,08	10,90
21 XL 037	21	6F	St	33,96	33,45	38	14,3	22,2	23,8	6,0	17,5	M4	0,09	11,20
22 XL 037	22	6F	St	35,57	35,06	42	14,3	22,2	25,4	6,0	19,1	M4	0,10	11,60
24 XL 037	24	6F	St	38,81	38,30	44	14,3	22,2	27,0	6,0	20,6	M4	0,12	12,80
26 XL 037	26	6F	St	42,04	41,53	48	14,3	22,2	30,0	6,0	23,0	M4	0,14	13,50
28 XL 037	28	6F	St	45,28	44,77	51	14,3	22,2	30,2	6,0	23,0	M4	0,16	13,80
30 XL 037	30	6F	St	48,51	48,00	54	14,3	22,2	34,9	6,0	23,0	M4	0,19	14,10
32 XL 037	32	6	Al	51,74	51,23	—	14,3	25,4	38,0	8,0	23,0	M4	0,11	15,40
36 XL 037	36	6	Al	58,21	57,70	—	14,3	25,4	38,0	8,0	23,0	M4	0,13	16,70
40 XL 037	40	6	Al	64,68	64,17	—	14,3	25,4	38,0	8,0	23,0	M4	0,17	18,00
42 XL 037	42	6W	Al	67,91	67,40	—	14,3	25,4	38,0	8,0	23,0	M4	0,13	21,50
44 XL 037	44	6W	Al	71,15	70,64	—	14,3	25,4	38,0	8,0	23,0	M4	0,15	22,80
48 XL 037	48	6W	Al	77,62	77,11	—	14,3	25,4	38,0	8,0	23,0	M4	0,16	24,10
60 XL 037	60	6A	Al	97,02	96,51	—	14,3	25,4	38,0	8,0	23,0	M4	0,18	27,00
72 XL 037	72	6A	Al	116,43	115,92	—	14,3	25,4	38,0	8,0	23,0	M4	0,23	31,80

Type L – Teilung Pitch 9,525 mm für Riemenbreite for belt width 050

10 L 050	10	6F	St	30,32	29,56	36	19	26	22	6,0	13,0	—	0,11	9,60
12 L 050	12	6F	St	36,38	35,62	42	19	26	28	6,0	17,0	—	0,19	10,60
13 L 050	13	6F	St	39,41	38,65	44	19	26	30	6,0	19,0	—	0,21	10,90
14 L 050	14	6F	St	42,45	41,68	48	19	26	33	8,0	20,0	—	0,25	11,60
15 L 050	15	6F	St	45,48	44,72	51	19	26	36	8,0	23,0	—	0,30	12,80
16 L 050	16	6F	St	48,51	47,75	54	19	26	38	8,0	23,0	—	0,33	13,50
17 L 050	17	6F	St	51,54	50,78	57	19	26	40	10,0	24,0	—	0,36	14,10
18 L 050	18	6F	St	54,57	53,81	60	19	26	40	10,0	24,0	—	0,41	15,10
19 L 050	19	6F	St	57,61	56,84	60	19	26	40	10,0	24,0	—	0,45	15,70
20 L 050	20	6F	St	60,64	59,88	66	19	26	46	10,0	28,0	—	0,50	16,40
21 L 050	21	6F	St	63,67	62,91	71	19	26	46	10,0	28,0	—	0,55	16,70
22 L 050	22	6F	St	66,70	65,94	75	19	26	50	10,0	30,0	—	0,62	17,00
24 L 050	24	6F	St	72,77	72,00	79	19	26	50	12,0	30,0	—	0,68	18,00
26 L 050	26	6F	St	78,83	78,07	87	19	26	50	12,0	30,0	—	0,82	20,50
28 L 050	28	6F	St	84,89	84,13	91	19	26	50	12,0	30,0	—	0,92	21,80
30 L 050	30	6F	St	90,96	90,20	97	19	26	50	12,0	30,0	—	1,10	22,80
32 L 050	32	6F	St	97,02	96,26	103	19	26	50	12,0	30,0	—	1,20	24,70
36 L 050	36	6WF	GG	109,15	108,38	115	19	26	50	12,0	30,0	—	1,00	28,90
40 L 050	40	6WF	GG	121,28	120,51	127	19	26	50	12,0	30,0	—	1,10	32,40
44 L 050	44	6AF	GG	133,40	132,64	140	19	26	50	12,0	30,0	—	1,20	35,60
48 L 050	48	6AF	GG	145,53	144,77	152	19	26	50	12,0	30,0	—	1,30	39,20
60 L 050	60	6A	GG	181,91	181,15	—	19	28	50	15,0	30,0	—	1,30	40,50
72 L 050	72	6A	GG	218,30	217,53	—	19	28	50	15,0	30,0	—	1,70	46,60
84 L 050	84	6A	GG	254,68	253,92	—	19	28	50	15,0	30,0	—	1,90	52,60

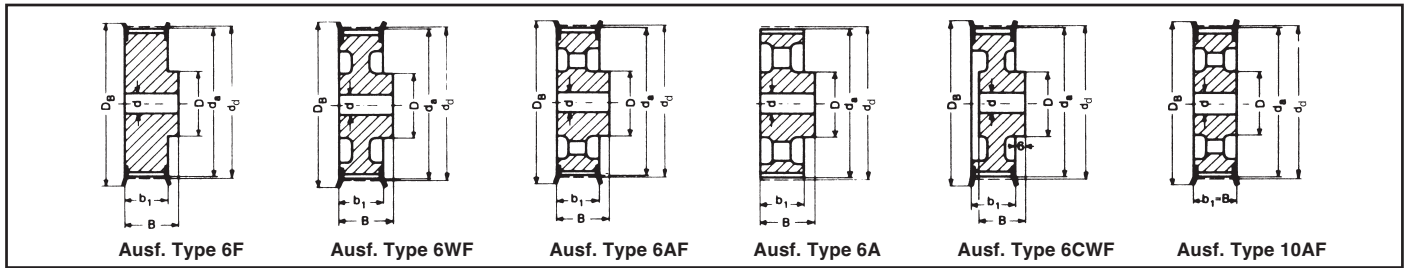

Type L – Teilung Pitch 9,525 mm für Riemenbreite for belt width 075

Bezeichnung Part No.	Anzahl der Zähne No. of teeth	Aus- führung Type	Material	d _g (mm)	d _a (mm)	D _B (mm)	b ₁ (mm)	B (mm)	D (mm)	Vor- bohrung Pilot bore d (mm)	Fertig- bohrung Finished bore d _{max} (mm)	Gewicht Weight (= kg)	€ Stück each
10 L 075	10	6F	St	30,32	29,56	36	25	32	22	6	13	0,15	10,60
12 L 075	12	6F	St	36,38	35,62	42	25	32	28	8	17	0,23	11,20
13 L 075	13	6F	St	39,41	38,65	44	25	32	30	8	19	0,26	12,20
14 L 075	14	6F	St	42,45	41,68	48	25	32	33	8	20	0,32	13,50
15 L 075	15	6F	St	45,48	44,72	51	25	32	36	8	23	0,35	14,10
16 L 075	16	6F	St	48,51	47,75	54	25	32	38	8	23	0,42	14,80
17 L 075	17	6F	St	51,54	50,78	57	25	32	40	10	24	0,45	15,70
18 L 075	18	6F	St	54,57	53,81	60	25	32	40	10	24	0,51	16,70
19 L 075	19	6F	St	57,61	56,84	60	25	32	40	10	24	0,57	17,30
20 L 075	20	6F	St	60,64	59,88	66	25	32	46	10	28	0,63	18,00
21 L 075	21	6F	St	63,67	62,91	71	25	32	46	10	28	0,70	18,30
22 L 075	22	6F	St	66,70	65,94	75	25	32	50	10	30	0,75	18,60
24 L 075	24	6F	St	72,77	72,00	79	25	32	50	12	30	0,85	20,50
26 L 075	26	6F	St	78,83	78,07	87	25	32	50	12	30	1,00	22,50
28 L 075	28	6F	St	84,89	84,13	91	25	32	50	12	30	1,20	23,10
30 L 075	30	6F	St	90,96	90,20	97	25	32	50	12	30	1,40	25,70
32 L 075	32	6F	St	97,02	96,26	103	25	32	50	12	30	1,50	27,00
36 L 075	36	6WF	GG	109,15	108,38	115	25	32	55	12	32	1,30	32,40
40 L 075	40	6WF	GG	121,28	120,51	127	25	32	60	12	35	1,60	38,20
44 L 075	44	6AF	GG	133,40	132,64	140	25	32	60	12	35	1,70	42,10
48 L 075	48	6AF	GG	145,53	144,77	152	25	32	60	12	35	1,90	46,60
60 L 075	60	6A	GG	181,91	181,15	—	26	35	60	15	35	1,80	49,10
72 L 075	72	6A	GG	218,30	217,53	—	26	35	60	15	35	2,30	54,60
84 L 075	84	6A	GG	254,68	253,92	—	26	35	60	15	35	2,50	62,90

Type L – Teilung Pitch 9,525 mm für Riemenbreite for belt width 100

10 L 100	10	6F	St	30,32	29,56	36	31	38	22	6	13	0,81	11,60
12 L 100	12	6F	St	36,38	35,62	42	31	38	28	8	17	0,29	12,20
13 L 100	13	6F	St	39,41	38,65	44	31	38	30	8	19	0,30	13,50
14 L 100	14	6F	St	42,45	41,68	48	31	38	33	8	20	0,38	14,50
15 L 100	15	6F	St	45,48	44,72	51	31	38	36	8	23	0,40	15,10
16 L 100	16	6F	St	48,51	47,75	54	31	38	38	8	23	0,51	15,70
17 L 100	17	6F	St	51,54	50,78	57	31	38	40	10	24	0,54	16,70
18 L 100	18	6F	St	54,57	53,81	60	31	38	40	10	24	0,62	17,30
19 L 100	19	6F	St	57,61	56,84	60	31	38	40	10	24	0,69	18,30
20 L 100	20	6F	St	60,64	59,88	66	31	38	46	10	28	0,76	18,90
21 L 100	21	6F	St	63,67	62,91	71	31	38	46	10	28	0,82	20,20
22 L 100	22	6F	St	66,70	65,94	75	31	38	50	10	30	0,92	21,50
24 L 100	24	6F	St	72,77	72,00	79	31	38	50	12	30	1,10	22,80
26 L 100	26	6F	St	78,83	78,07	87	31	38	50	12	30	1,30	24,10
28 L 100	28	6F	St	84,89	84,13	91	31	38	50	12	30	1,40	26,00
30 L 100	30	6F	St	90,96	90,20	97	31	38	50	12	30	1,70	27,90
32 L 100	32	6F	St	97,02	96,26	103	31	38	50	12	30	1,80	29,90
36 L 100	36	6CWF	GG	109,15	108,38	115	32	32	55	12	32	1,50	35,60
40 L 100	40	6CWF	GG	121,28	120,51	127	32	32	60	12	35	1,80	39,20
44 L 100	44	10AF	GG	133,40	132,64	140	32	32	60	12	35	1,90	47,20
48 L 100	48	10AF	GG	145,53	144,77	152	32	32	60	12	35	2,10	49,80
60 L 100	60	6A	GG	181,91	181,15	—	32	35	60	15	35	2,00	51,00
72 L 100	72	6A	GG	218,30	217,53	—	32	35	60	15	35	2,50	58,70
84 L 100	84	6A	GG	254,68	253,92	—	32	35	60	15	35	2,70	66,10

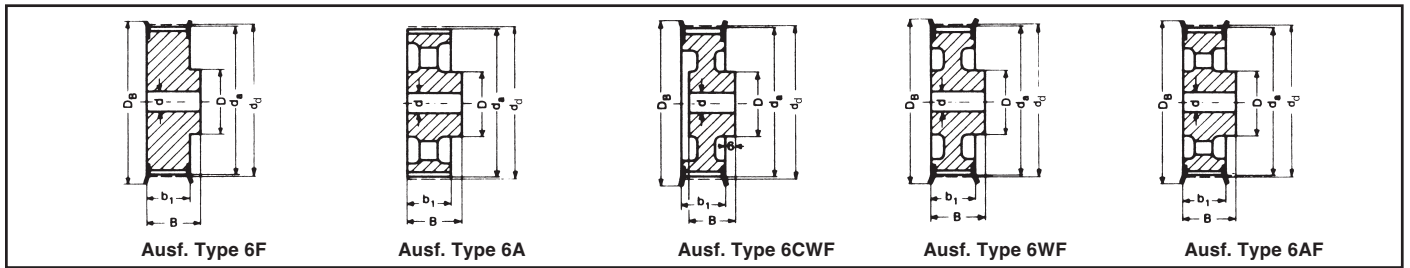

Type H – Teilung Pitch 12,7 mm für Riemenbreite for belt width 075

Bezeichnung Part No.	Anzahl der Zähne No. of teeth	Aus- führung Type	Material	d _d (mm)	d _a (mm)	D _B (mm)	b ₁ (mm)	B (mm)	D (mm)	Vor- bohrung Pilot bore d (mm)	Fertig- bohrung Finished bore d _{max} (mm)	Gewicht Weight (= kg)	€ Stück each
14 H 075	14	6F	St	56,60	55,22	64,0	26,4	40	40	10	24	0,50	17,30
16 H 075	16	6F	St	64,67	63,31	70,0	26,4	40	46	10	26	0,60	18,60
18 H 075	18	6F	St	72,77	71,39	79,0	26,4	40	54	12	32	0,80	20,20
19 H 075	19	6F	St	76,81	75,44	82,5	26,4	40	58	12	35	1,00	21,50
20 H 075	20	6F	St	80,85	79,48	87,0	26,4	40	62	12	35	1,10	22,80
21 H 075	21	6F	St	84,89	83,52	91,0	26,4	40	67	12	38	1,20	23,40
22 H 075	22	6F	St	88,94	87,56	94,0	26,4	40	70	12	38	1,40	24,40
24 H 075	24	6F	St	97,02	95,65	102,0	26,4	40	75	12	42	1,60	27,30
26 H 075	26	6F	St	105,11	103,73	112,0	26,4	40	80	15	45	1,80	30,80
28 H 075	28	6F	GG	113,19	111,82	120,0	26,4	40	80	15	45	2,00	32,70
30 H 075	30	6F	GG	121,28	119,90	128,0	26,4	40	80	15	45	2,10	34,40
32 H 075	32	6F	GG	129,36	127,99	135,0	26,4	40	70	15	45	2,20	39,50
36 H 075	36	6F	GG	145,53	144,16	152,0	26,4	40	80	20	45	2,40	43,70
40 H 075	40	6F	GG	161,70	160,33	168,0	26,4	40	80	20	45	2,80	49,40
44 H 075	44	6AF	GG	177,87	176,50	184,0	26,4	40	80	20	45	2,70	52,30
48 H 075	48	6AF	GG	194,04	192,67	200,0	26,4	40	90	20	50	3,00	55,20

Type H – Teilung Pitch 12,7 mm für Riemenbreite for belt width 100

14 H 100	14	6F	St	56,60	55,22	63	31	41	40	10	24	0,65	19,60
16 H 100	16	6F	St	64,68	63,31	71	31	41	46	10	28	0,85	21,50
18 H 100	18	6F	St	72,77	71,39	79	31	41	54	12	32	1,10	23,10
19 H 100	19	6F	St	76,81	75,44	83	31	41	58	12	34	1,20	24,40
20 H 100	20	6F	St	80,85	79,48	87	31	41	62	12	35	1,40	25,70
21 H 100	21	6F	St	84,89	83,52	91	31	41	67	12	38	1,60	26,60
22 H 100	22	6F	St	88,94	87,56	93	31	41	70	12	41	1,70	27,60
24 H 100	24	6F	St	97,02	95,65	103	31	41	75	12	45	2,00	31,10
26 H 100	26	6CWF	GG	105,11	103,73	111	32	32	55	15	32	1,40	35,00
28 H 100	28	6CWF	GG	113,19	111,82	119	32	32	60	15	35	1,60	36,90
30 H 100	30	6CWF	GG	121,28	119,90	127	32	32	60	15	35	1,70	39,20
32 H 100	32	6WF	GG	129,36	127,99	135	32	40	70	20	40	2,20	44,60
36 H 100	36	6WF	GG	145,53	144,16	152	32	40	80	20	45	3,00	49,80
40 H 100	40	6AF	GG	161,70	160,33	168	32	40	80	20	45	2,80	56,20
44 H 100	44	6AF	GG	177,87	176,50	184	32	40	80	20	45	3,10	59,40
48 H 100	48	6AF	GG	194,04	192,67	200	32	40	80	20	45	3,30	62,90
60 H 100	60	6A	GG	242,55	241,18	—	34	45	80	20	45	5,50	77,70
72 H 100	72	6A	GG	291,06	289,69	—	34	45	80	20	45	7,10	104,00
84 H 100*	84	6A	GG	339,57	338,20	—	34	45	80	20	45	8,20	125,00
96 H 100*	96	6A	GG	388,08	386,71	—	34	45	80	20	45	9,90	149,00
120 H 100*	120	6A	GG	485,10	483,73	—	34	50	90	20	50	13,10	205,00

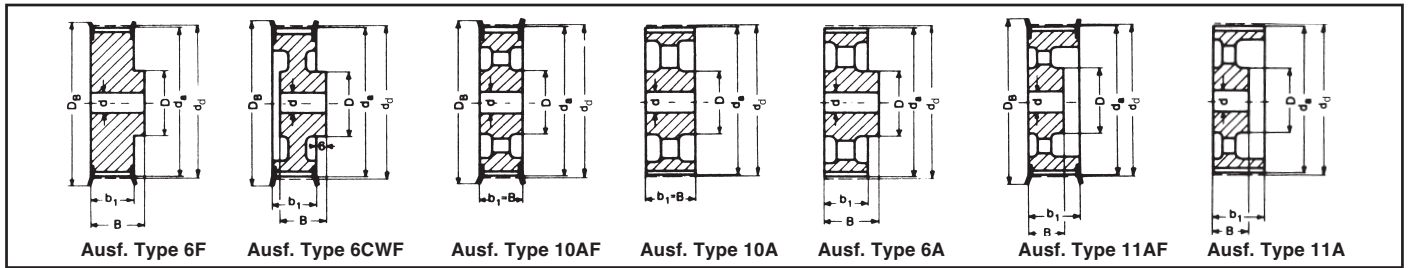

Type H – Teilung Pitch 12,7 mm für Riemenbreite for belt width 150

Bezeichnung Part No.	Anzahl der Zähne No. of teeth	Aus- führung Type	Material	d _g (mm)	d _a (mm)	D _B (mm)	b ₁ (mm)	B (mm)	D (mm)	Vor- bohrung Pilot bore d (mm)	Fertig- bohrung Finished bore d _{max} (mm)	Gewicht Weight (= kg)	€ Stück each
14 H 150	14	6F	St	56,60	55,22	63	44	54	40	12	24	0,82	23,10
16 H 150	16	6F	St	64,68	63,31	71	44	54	46	12	28	1,10	25,40
18 H 150	18	6F	St	72,77	71,39	79	44	54	54	12	32	1,50	27,60
19 H 150	19	6F	St	76,81	75,44	83	44	54	58	12	34	1,70	29,90
20 H 150	20	6F	St	80,85	79,48	87	44	54	62	12	35	1,80	31,50
21 H 150	21	6F	St	84,89	83,52	91	44	54	67	12	38	2,20	33,40
22 H 150	22	6F	St	88,94	87,56	93	44	54	70	12	41	2,30	35,60
24 H 150	24	6F	St	97,02	95,65	103	44	54	75	12	45	2,60	37,90
26 H 150	26	6CWF	GG	105,11	103,73	111	45	35	55	15	32	1,70	39,80
28 H 150	28	6CWF	GG	113,19	111,82	119	45	35	60	15	35	1,90	42,40
30 H 150	30	6CWF	GG	121,28	119,90	127	45	35	60	15	35	2,10	44,90
32 H 150	32	6CWF	GG	129,36	127,99	135	45	45	70	20	40	2,60	50,10
36 H 150	36	6CWF	GG	145,53	144,16	152	45	45	80	20	45	3,20	56,80
40 H 150	40	10AF	GG	161,70	160,33	168	45	45	80	20	45	3,80	66,80
44 H 150	44	10AF	GG	177,87	176,50	184	45	45	80	20	45	3,70	70,60
48 H 150	48	10AF	GG	194,04	192,67	200	45	45	80	20	45	4,00	73,80
60 H 150	60	10A	GG	242,55	241,18	—	46	46	85	20	48	5,10	96,90
72 H 150	72	10A	GG	291,06	289,69	—	46	46	85	20	48	7,90	117,00
84 H 150*	84	10A	GG	339,57	338,20	—	46	46	85	20	48	8,90	146,00
96 H 150*	96	10A	GG	388,08	386,71	—	46	46	85	20	48	10,10	167,00
120 H 150*	120	6A	GG	485,10	483,73	—	46	55	95	24	55	17,20	239,00

Type H – Teilung Pitch 12,7 mm für Riemenbreite for belt width 200

14 H 200	14	6F	St	56,60	55,22	63	58	68	40	12	24	1,1	26,30
16 H 200	16	6F	St	64,68	63,31	71	58	68	46	15	28	1,4	29,90
18 H 200	18	6F	St	72,77	71,39	79	58	68	54	15	32	1,8	32,40
19 H 200	19	6F	St	76,81	75,44	83	58	68	58	15	34	2,1	34,40
20 H 200	20	6F	St	80,85	79,48	87	58	68	62	15	35	2,3	35,60
21 H 200	21	6F	St	84,89	83,52	91	58	68	67	15	38	2,6	37,90
22 H 200	22	6F	St	88,94	87,56	93	58	68	70	15	41	2,8	39,80
24 H 200	24	6F	St	97,02	95,65	103	58	68	75	15	45	3,4	43,70
26 H 200	26	6CWF	GG	105,11	103,73	111	58	42	60	15	35	2,3	45,60
28 H 200	28	6CWF	GG	113,19	111,82	119	58	42	60	15	35	2,5	49,10
30 H 200	30	6CWF	GG	121,28	119,90	127	58	42	70	15	40	2,9	52,30
32 H 200	32	6CWF	GG	129,36	127,99	135	58	47	70	20	40	3,2	54,60
36 H 200	36	6CWF	GG	145,53	144,16	152	58	47	80	20	45	3,8	63,60
40 H 200	40	11AF	GG	161,70	160,33	168	58	45	80	20	45	4,1	77,70
44 H 200	44	11AF	GG	177,87	176,50	184	58	45	80	20	45	4,4	84,10
48 H 200	48	11AF	GG	194,04	192,67	200	58	45	85	20	48	5,1	89,20
60 H 200	60	11A	GG	242,55	241,18	—	60	50	90	20	50	7,1	114,00
72 H 200	72	11A	GG	291,06	289,69	—	60	50	90	20	50	8,0	150,00
84 H 200*	84	11A	GG	339,57	338,20	—	60	50	90	20	50	12,0	178,00
96 H 200*	96	11A	GG	388,08	386,71	—	60	50	90	20	50	13,6	203,00
120 H 200*	120	10A	GG	485,10	483,73	—	60	60	100	24	57	16,6	286,00

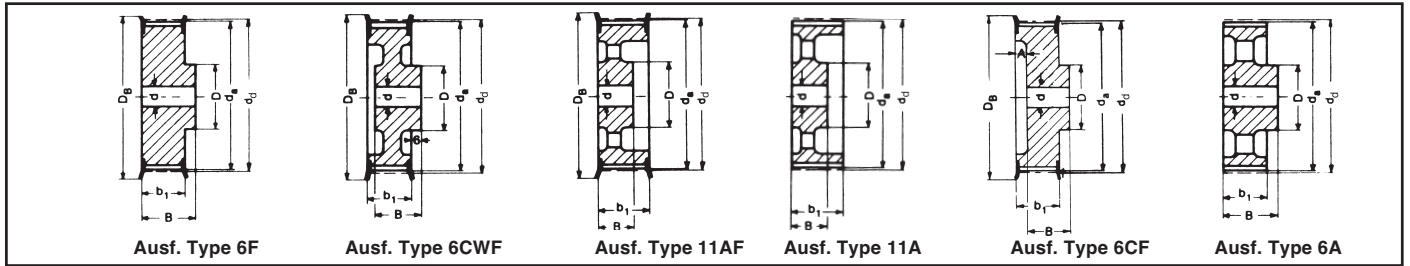

Type H – Teilung Pitch 12,7 mm für Riemenbreite for belt width 300

Bezeichnung Part No.	Anzahl der Zähne No. of teeth	Aus- führung Type	Material	d _d (mm)	d _a (mm)	D _B (mm)	b ₁ (mm)	B (mm)	D (mm)	A (mm)	Vor- bohrung Pilot bore d (mm)	Fertig- bohrung Finished bore d _{max} (mm)	Gewicht Weight (= kg)	€ Stück each
16 H 300	16	6F	St	64,68	63,31	71	84	94	46	—	15	28	2,0	36,30
18 H 300	18	6F	St	72,77	71,39	79	84	94	54	—	15	32	2,6	39,80
19 H 300	19	6F	St	76,81	75,44	83	84	94	58	—	15	34	2,9	42,10
20 H 300	20	6F	St	80,85	79,48	87	84	94	62	—	15	35	3,2	44,00
21 H 300	21	6F	St	84,89	83,52	91	84	94	67	—	15	38	3,6	46,90
22 H 300	22	6F	St	88,94	87,56	93	84	94	70	—	15	41	4,0	49,40
24 H 300	24	6F	St	97,02	95,65	103	84	94	75	—	15	45	4,7	54,60
26 H 300	26	6CWF	GG	105,11	103,73	111	84	57	60	—	15	35	3,3	69,30
28 H 300	28	6CWF	GG	113,19	111,82	119	84	57	60	—	15	35	3,6	76,10
30 H 300	30	6CWF	GG	121,28	119,90	127	84	57	70	—	15	40	4,2	84,10
32 H 300	32	6CWF	GG	129,36	127,99	135	84	57	70	—	20	40	4,3	90,80
36 H 300	36	6CWF	GG	145,53	144,16	152	84	57	80	—	20	45	5,2	101,00
40 H 300	40	11AF	GG	161,70	160,33	168	84	55	80	—	20	45	5,6	107,00
44 H 300	44	11AF	GG	177,87	176,50	184	84	55	80	—	20	45	5,9	114,00
48 H 300	48	11AF	GG	194,04	192,67	200	84	55	85	—	20	48	6,6	122,00
60 H 300	60	11A	GG	242,55	241,18	—	86	55	100	—	20	57	9,9	154,00
72 H 300	72	11A	GG	291,06	289,69	—	86	55	100	—	20	57	13,0	199,00
84 H 300*	84	11A	GG	339,57	338,20	—	86	55	100	—	20	57	15,1	227,00
96 H 300*	96	11A	GG	388,08	386,71	—	86	55	100	—	20	57	18,2	264,00
120 H 300*	120	11A	GG	485,10	483,73	—	86	65	110	—	24	62	26,0	364,00

Type XH – Teilung Pitch 22,25 mm für Riemenbreite for belt width 200

18 XH 200*	18	6CF	GG	127,34	124,55	142	64,4	60	85	18	20	50	5,0	146,00
20 XH 200*	20	6CF	GG	141,49	138,69	155	64,4	60	95	18	20	55	6,0	154,00
22 XH 200*	22	6CF	GG	155,64	152,84	170	64,4	60	110	18	20	65	7,2	166,00
24 XH 200*	24	6CF	GG	169,79	166,69	184	64,4	60	125	18	25	70	8,6	186,00
26 XH 200*	26	6CF	GG	183,94	181,14	198	64,4	60	140	18	25	80	10,1	213,00
28 XH 200*	28	6CWF	GG	198,08	195,29	212	64,4	60	120	18	25	70	9,6	253,00
30 XH 200*	30	6CWF	GG	212,23	209,44	227	64,4	60	120	18	25	70	10,4	275,00
32 XH 200*	32	6CWF	GG	226,38	223,59	240	64,4	60	130	18	25	75	11,2	297,00
40 XH 200*	40	6CWF	GG	282,98	280,18	297	64,4	60	140	18	25	80	16,0	407,00
48 XH 200*	48	6A	GG	339,57	336,78	—	65,0	80	150	—	30	85	18,4	469,00
60 XH 200*	60	6A	GG	424,47	421,67	—	65,0	80	150	—	30	85	24,3	556,00
72 XH 200*	72	6A	GG	509,36	506,57	—	65,0	80	150	—	40	85	28,1	778,00
84 XH 200*	84	6A	GG	594,25	591,46	—	65,0	80	160	—	40	90	31,9	1.087,00
96 XH 200*	96	6A	GG	679,15	676,35	—	65,0	80	160	—	40	90	37,0	1.411,00

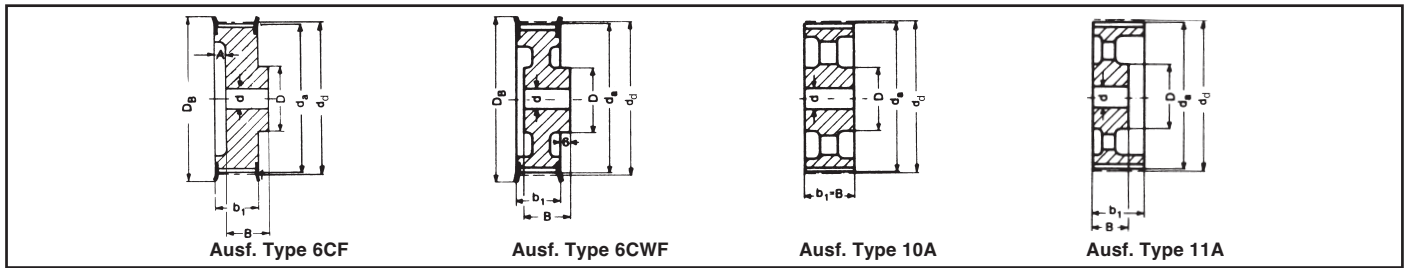

Type XH – Teilung Pitch 22,225 mm für Riemenbreite for belt width 300

Bezeichnung Part No.	Anzahl der Zähne No. of teeth	Aus- führung Type	Material	d _d (mm)	d _a (mm)	D _B (mm)	b ₁ (mm)	B (mm)	D (mm)	A (mm)	Vor- bohrung Pilot bore d (mm)	Fertig- bohrung Finished bore d _{max} (mm)	Gewicht Weight (≈ kg)	€ Stück each
18 XH 300*	18	6CF	GG	127,34	124,55	142	91,4	70	85	35	20	50	6,8	189,00
20 XH 300*	20	6CF	GG	141,49	138,69	155	91,4	70	95	35	20	55	7,4	199,00
22 XH 300*	22	6CF	GG	155,64	152,84	170	91,4	70	110	35	20	65	9,0	225,00
24 XH 300*	24	6CF	GG	169,79	166,69	184	91,4	70	125	35	25	70	10,6	258,00
26 XH 300*	26	6CF	GG	183,94	181,14	198	91,4	70	140	35	25	80	13,0	292,00
28 XH 300*	28	6CWF	GG	198,08	195,29	212	91,4	70	120	35	25	70	12,0	332,00
30 XH 300*	30	6CWF	GG	212,23	209,44	227	91,4	70	120	35	25	70	13,0	363,00
32 XH 300*	32	6CWF	GG	226,38	223,59	240	91,4	70	130	35	25	75	14,7	396,00
40 XH 300*	40	6CWF	GG	282,98	280,18	297	91,4	70	140	35	25	80	19,9	556,00
48 XH 300*	48	10A	GG	339,57	336,78	—	92,0	92	150	—	30	85	22,5	621,00
60 XH 300*	60	10A	GG	424,47	421,67	—	92,0	92	150	—	30	85	31,5	754,00
72 XH 300*	72	10A	GG	509,36	506,57	—	92,0	92	150	—	40	85	36,4	952,00
84 XH 300*	84	10A	GG	594,25	591,46	—	92,0	92	160	—	40	90	43,4	1.295,00
96 XH 300*	96	10A	GG	679,15	676,35	—	92,0	92	160	—	40	90	48,5	1.802,00

Type XH – Teilung Pitch 22,225 mm für Riemenbreite for belt width 400

18 XH 400*	18	6CF	GG	127,34	124,55	142	118,4	85	85	47	20	50	8,5	234,00
20 XH 400*	20	6CF	GG	141,49	138,69	155	118,4	85	95	47	20	55	9,4	259,00
22 XH 400*	22	6CF	GG	155,64	152,84	170	118,4	85	110	47	20	65	11,5	284,00
24 XH 400*	24	6CF	GG	169,79	166,69	184	118,4	85	125	47	25	70	13,4	334,00
26 XH 400*	26	6CF	GG	183,94	181,14	198	118,4	85	140	47	25	80	15,6	392,00
28 XH 400*	28	6CWF	GG	198,08	195,29	212	118,4	85	120	47	25	70	14,5	428,00
30 XH 400*	30	6CWF	GG	212,23	209,44	227	118,4	85	120	47	25	70	16,0	452,00
32 XH 400*	32	6CWF	GG	226,38	223,59	240	118,4	85	130	47	25	75	18,0	496,00
40 XH 400*	40	6CWF	GG	282,98	280,18	297	118,4	85	140	47	25	80	24,0	685,00
48 XH 400*	48	11A	GG	339,57	336,78	—	119,0	92	150	—	30	85	30,8	789,00
60 XH 400*	60	11A	GG	424,47	421,67	—	119,0	92	150	—	30	85	36,2	916,00
72 XH 400*	72	11A	GG	509,36	506,57	—	119,0	92	150	—	40	85	42,7	1.190,00
84 XH 400*	84	11A	GG	594,25	591,46	—	119,0	92	160	—	40	90	49,7	1.607,00
96 XH 400*	96	11A	GG	679,15	676,35	—	119,0	92	160	—	40	90	59,9	2.317,00

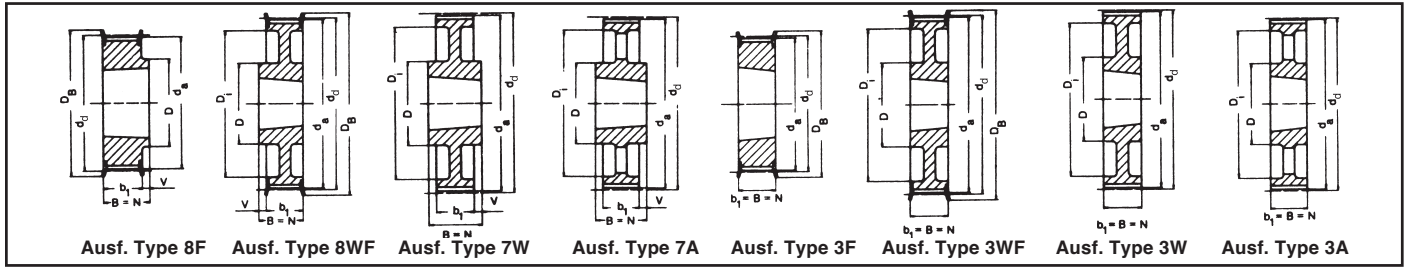

Type L – Teilung Pitch 9,525 mm für Riemenbreite for belt width 050

Bezeichnung Part No.	Anzahl der Zähne No. of teeth	Aus- führung Type	Mate- rial	d _d (mm)	d _a (mm)	D _B (mm)	b ₁ (mm)	B (mm)	N (mm)	V (mm)	Z (mm)	D (mm)	D ₁ (mm)	Taper- Buchse Taper bush	Gewicht ohne Buchse Weight without bush (= kg)	€ Stück ohne Buchse each without bush
TB 18 L 050	18	8F	St	54,57	53,81	60	19,0	22,0	22,0	3,0	—	44	—	1108	0,2	20,50
TB 19 L 050	19	8F	St	57,61	56,84	60	19,0	22,0	22,0	3,0	—	44	—	1108	0,2	21,20
TB 20 L 050	20	8F	St	60,64	59,88	66	19,0	22,0	22,0	3,0	—	48	—	1108	0,2	21,50
TB 21 L 050	21	8F	St	63,67	62,91	71	19,0	22,0	22,0	3,0	—	48	—	1108	0,3	22,50
TB 22 L 050	22	8F	St	66,70	65,94	75	19,0	22,0	22,0	3,0	—	51	—	1108	0,3	23,10
TB 23 L 050	23	8F	GG	69,73	68,97	79	19,0	22,0	22,0	3,0	—	54	—	1108	0,4	23,80
TB 24 L 050	24	8F	GG	72,77	72,00	79	19,0	22,0	22,0	3,0	—	54	—	1108	0,4	24,40
TB 25 L 050	25	8F	GG	75,80	75,04	83	19,0	22,0	22,0	3,0	—	56	—	1108	0,5	25,00
TB 26 L 050	26	8F	GG	78,83	78,07	87	19,0	22,0	22,0	3,0	—	60	—	1108	0,5	25,70
TB 27 L 050	27	8F	GG	81,86	81,10	87	19,0	22,0	22,0	3,0	—	65	—	1108	0,6	26,30
TB 28 L 050	28	8F	GG	84,89	84,13	91	19,0	22,0	22,0	3,0	—	65	—	1108	0,6	27,00
TB 30 L 050	30	8F	GG	90,96	90,20	97	19,0	22,0	22,0	3,0	—	70	—	1108	0,8	28,90
TB 32 L 050	32	8F	GG	97,02	96,26	103	19,0	22,0	22,0	3,0	—	74	—	1108	0,9	31,10
TB 36 L 050	36	8F	GG	109,15	108,39	115	19,0	22,0	22,0	3,0	—	87	—	1108	1,2	33,40
TB 40 L 050	40	8F	GG	121,28	120,51	127	19,0	25,0	25,0	6,0	—	97	—	1610	1,5	39,20
TB 48 L 050	48	8WF	GG	145,53	144,77	152	19,0	25,0	25,0	6,0	—	88	124	1610	2,3	49,80
TB 60 L 050	60	7W	GG	181,91	181,15	—	19,0	25,0	25,0	3,0	—	92	166	1610	2,0	57,80
TB 72 L 050	72	7A	GG	218,30	217,53	—	19,0	25,0	25,0	3,0	—	92	202	1610	3,0	67,70
TB 84 L 050	84	7A	GG	254,68	253,90	—	19,0	25,0	25,0	3,0	—	92	236	1610	4,0	79,60
TB 96 L 050	96	7A	GG	291,06	290,30	—	19,0	32,0	32,0	6,5	—	106	270	2012	5,5	102,00
TB 120 L 050	120	7A	GG	363,83	363,07	—	19,0	32,0	32,0	6,5	—	106	343	2012	6,8	131,00

Type L – Teilung Pitch 9,525 mm für Riemenbreite for belt width 075

TB 18 L 075	18	3F	St	54,57	53,81	60	25,0	25,0	25,0	—	—	—	—	1108	0,2	22,80
TB 19 L 075	19	3F	St	57,61	56,84	60	25,0	25,0	25,0	—	—	—	—	1108	0,3	23,80
TB 20 L 075	20	3F	St	60,64	59,88	66	25,0	25,0	25,0	—	—	—	—	1108	0,3	24,10
TB 21 L 075	21	3F	St	63,67	62,91	71	25,0	25,0	25,0	—	—	—	—	1108	0,4	25,00
TB 22 L 075	22	3F	St	66,70	65,94	75	25,0	25,0	25,0	—	—	—	—	1108	0,4	25,70
TB 23 L 075	23	3F	GG	69,73	68,97	79	25,0	25,0	25,0	—	—	—	—	1108	0,4	26,60
TB 24 L 075	24	3F	GG	72,77	72,00	79	25,0	25,0	25,0	—	—	—	—	1108	0,5	27,60
TB 25 L 075	25	3F	GG	75,80	75,04	83	25,0	25,0	25,0	—	—	—	—	1108	0,6	28,30
TB 26 L 075	26	3F	GG	78,83	78,07	87	25,0	25,0	25,0	—	—	—	—	1108	0,6	28,90
TB 27 L 075	27	3F	GG	81,86	81,10	87	25,0	25,0	25,0	—	—	—	—	1108	0,7	30,80
TB 28 L 075	28	3F	GG	84,89	84,13	91	25,0	25,0	25,0	—	—	—	—	1108	0,7	32,10
TB 30 L 075	30	3F	GG	90,96	90,20	97	25,0	25,0	25,0	—	—	—	—	1108	0,9	33,10
TB 32 L 075	32	3F	GG	97,02	96,26	103	25,0	25,0	25,0	—	—	—	—	1108	1,0	35,60
TB 36 L 075	36	3F	GG	109,15	108,39	115	25,0	25,0	25,0	—	—	—	—	1610	1,2	39,50
TB 40 L 075	40	3F	GG	121,28	120,51	127	25,0	25,0	25,0	—	—	—	—	1610	1,7	43,70
TB 48 L 075	48	3WF	GG	145,53	144,77	152	25,0	25,0	25,0	—	—	92	124	1610	2,5	51,70
TB 60 L 075	60	3W	GG	181,91	181,15	—	25,0	25,0	25,0	—	—	92	166	1610	3,0	61,30
TB 72 L 075	72	3A	GG	218,30	217,53	—	25,0	25,0	25,0	—	—	92	202	1610	4,0	76,10
TB 84 L 075	84	7A	GG	254,68	253,90	—	25,0	32,0	32,0	3,5	—	106	236	2012	5,2	92,50
TB 96 L 075	96	7A	GG	291,06	290,30	—	25,0	32,0	32,0	3,5	—	106	270	2012	6,5	114,00
TB 120 L 075	120	7A	GG	363,83	363,07	—	25,0	32,0	32,0	3,5	—	106	343	2012	7,6	142,00

Taper-Buchse Taper bush	1108	1610	2012
Bohrung d ₂ (mm) von ... bis ... Bore d ₂ (mm) from ... to ...	10-28	14-42	14-50
€/Stück each	7,00	11,00	13,50

St = Stahl Steel
GG = Grauguss Cast iron
Fertigungstechnische Änderungen vorbehalten.
We reserve the right to make technical changes.
Bohrungsdurchmesser d₂ siehe Seite 3.
Bore diameters d₂ see page 3.

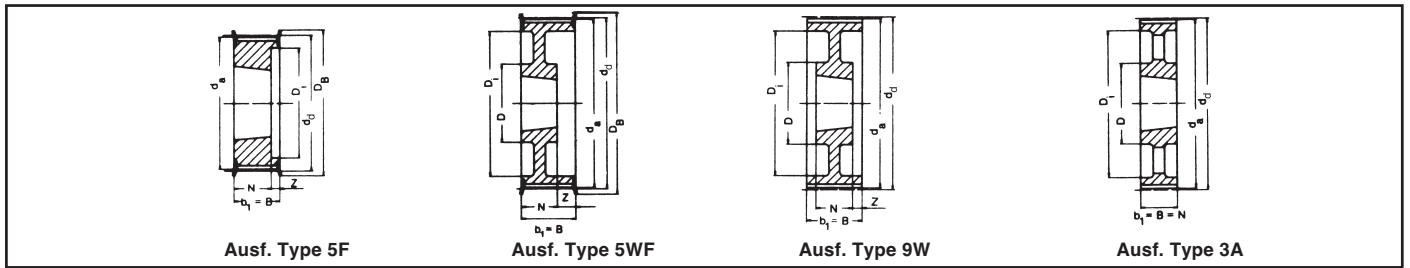

Type L – Teilung Pitch 9,525 mm für Riemenbreite for belt width 100

Bezeichnung Part No.	Anzahl der Zähne No. of teeth	Aus- führung Type	Mate- rial	d _d (mm)	d _a (mm)	D _B (mm)	b ₁ (mm)	B (mm)	N (mm)	V (mm)	Z (mm)	D (mm)	D ₁ (mm)	Taper- Buchse Taper bush	Gewicht ohne Buchse Weight without bush (= kg)	€ Stück ohne Buchse each without bush
TB 18 L 100	18	5F	St	54,57	53,81	60	31,0	31,0	22,0	—	9,0	—	38	1108	0,2	24,70
TB 19 L 100	19	5F	St	57,61	56,84	60	31,0	31,0	22,0	—	9,0	—	38	1108	0,3	25,70
TB 20 L 100	20	5F	St	60,64	59,88	66	31,0	31,0	22,0	—	9,0	—	45	1108	0,4	26,30
TB 21 L 100	21	5F	St	63,67	62,91	71	31,0	31,0	22,0	—	9,0	—	47	1108	0,4	27,30
TB 22 L 100	22	5F	St	66,70	65,94	75	31,0	31,0	22,0	—	9,0	—	51	1108	0,4	27,90
TB 23 L 100	23	5F	GG	69,73	68,97	79	32,0	32,0	22,0	—	10,0	—	54	1108	0,5	29,90
TB 24 L 100	24	5F	GG	72,77	72,00	79	32,0	32,0	22,0	—	10,0	—	54	1108	0,6	31,10
TB 25 L 100	25	5F	GG	75,80	75,04	83	32,0	32,0	22,0	—	10,0	—	56	1108	0,6	32,40
TB 26 L 100	26	5F	GG	78,83	78,07	87	32,0	32,0	22,0	—	10,0	—	60	1108	0,7	33,10
TB 27 L 100	27	5F	GG	81,86	81,10	87	32,0	32,0	22,0	—	10,0	—	62	1108	0,8	34,00
TB 28 L 100	28	5F	GG	84,89	84,13	91	32,0	32,0	22,0	—	10,0	—	65	1108	0,8	35,30
TB 30 L 100	30	5F	GG	90,96	90,20	97	32,0	32,0	25,0	—	7,0	—	71	1210	0,9	36,30
TB 32 L 100	32	5F	GG	97,02	96,26	103	32,0	32,0	25,0	—	7,0	—	75	1210	1,0	39,80
TB 36 L 100	36	5F	GG	109,15	108,39	115	32,0	32,0	25,0	—	7,0	—	89	1610	1,4	43,00
TB 40 L 100	40	5F	GG	121,28	120,51	127	32,0	32,0	25,0	—	7,0	—	101	1610	1,7	46,60
TB 48 L 100	48	5WF	GG	145,53	144,77	152	32,0	32,0	25,0	—	7,0	92	124	1610	2,7	57,10
TB 60 L 100	60	9W	GG	181,91	181,15	—	32,0	32,0	25,0	—	3,5	92	166	1610	2,4	67,70
TB 72 L 100	72	3A	GG	218,30	217,53	—	32,0	32,0	32,0	—	—	106	202	2012	4,4	84,70
TB 84 L 100	84	3A	GG	254,68	253,90	—	32,0	32,0	32,0	—	—	106	236	2012	6,0	99,20
TB 96 L 100	96	3A	GG	291,06	290,30	—	32,0	32,0	32,0	—	—	106	270	2012	7,1	121,00
TB 120 L 100	120	3A	GG	363,83	363,07	—	32,0	32,0	32,0	—	—	106	343	2012	8,5	154,00

Taper-Buchse Taper bush	1108	1210	1610	2012
Bohrung d ₂ (mm) von ... bis ... Bore d ₂ (mm) from ... to ...	10-28	11-32	14-42	14-50
€/Stück each	7,00	9,20	11,00	13,50

St = Stahl Steel
GG = Grauguss Cast iron
Fertigungstechnische Änderungen vorbehalten.
We reserve the right to make technical changes.
Bohrungsdurchmesser d₂ siehe Seite 3.
Bore diameters d₂ see page 3.

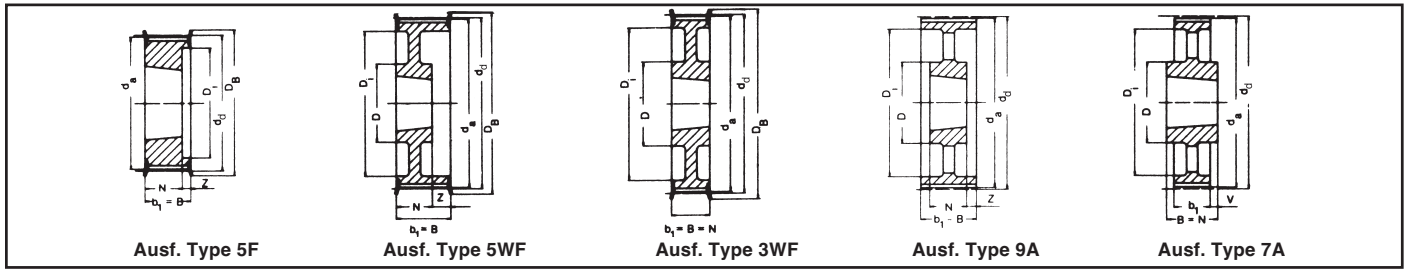

Type H – Teilung Pitch 12,7 mm für Riemenbreite for belt width 100

Bezeichnung Part No.	Anzahl der Zähne No. of teeth	Aus- führung Type	Mate- rial	d _d (mm)	d _a (mm)	D _B (mm)	b ₁ (mm)	B (mm)	N (mm)	V (mm)	Z (mm)	D (mm)	D ₁ (mm)	Taper- Buchse Taper bush	Gewicht ohne Buchse Weight without bush (= kg)	€ Stück ohne Buchse each without bush
TB 16 H 100	16	5F	St	64,68	63,31	71	31,0	31,0	22,0	—	9,0	—	45	1108	0,4	24,70
TB 18 H 100	18	5F	St	72,77	71,39	79	31,0	31,0	25,0	—	6,0	—	52	1210	0,5	28,60
TB 19 H 100	19	5F	St	76,81	75,44	83	31,0	31,0	25,0	—	6,0	—	56	1210	0,6	30,20
TB 20 H 100	20	5F	St	80,55	79,48	87	31,0	31,0	25,0	—	6,0	—	60	1210	0,7	31,50
TB 21 H 100	21	5F	GG	84,89	83,52	91	32,0	32,0	25,0	—	7,0	—	63	1210	0,8	33,10
TB 22 H 100	22	5F	GG	88,94	87,56	93	32,0	32,0	25,0	—	7,0	—	67	1210	0,9	34,70
TB 23 H 100	23	5F	GG	92,98	91,61	97	32,0	32,0	25,0	—	7,0	—	71	1610	0,9	36,00
TB 24 H 100	24	5F	GG	97,02	95,65	103	32,0	32,0	25,0	—	7,0	—	75	1610	1,0	37,20
TB 25 H 100	25	5F	GG	101,06	99,69	106	32,0	32,0	25,0	—	7,0	—	79	1610	1,0	39,20
TB 26 H 100	26	5F	GG	105,11	103,73	111	32,0	32,0	25,0	—	7,0	—	83	1610	1,2	40,50
TB 27 H 100	27	5F	GG	109,15	107,78	115	32,0	32,0	25,0	—	7,0	—	87	1610	1,3	42,10
TB 28 H 100	28	5F	GG	113,19	111,82	119	32,0	32,0	25,0	—	7,0	—	91	1610	1,5	43,70
TB 30 H 100	30	5F	GG	121,28	119,90	127	32,0	32,0	25,0	—	7,0	—	99	1610	1,7	46,60
TB 32 H 100	32	5WF	GG	129,36	127,99	135	32,0	32,0	25,0	—	7,0	92	108	1610	2,0	51,00
TB 36 H 100	36	5WF	GG	145,53	144,16	152	32,0	32,0	25,0	—	7,0	92	124	1610	2,7	57,80
TB 40 H 100	40	5WF	GG	161,70	160,33	168	32,0	32,0	25,0	—	7,0	92	140	1610	3,6	64,50
TB 44 H 100	44	3WF	GG	177,87	176,50	184	32,0	32,0	32,0	—	—	106	153	2012	3,8	72,20
TB 48 H 100	48	3WF	GG	194,04	192,67	200	32,0	32,0	32,0	—	—	106	169	2012	3,2	82,80
TB 60 H 100	60	9A	GG	242,55	241,18	—	34,0	34,0	32,0	—	1,0	106	223	2012	4,8	97,60
TB 72 H 100	72	9A	GG	291,06	289,69	—	34,0	34,0	32,0	—	1,0	106	270	2012	5,7	114,00
TB 84 H 100*	84	9A	GG	339,57	338,20	—	34,0	34,0	32,0	—	1,0	106	318	2012	6,8	136,00
TB 96 H 100*	96	7A	GG	388,08	386,71	—	34,0	45,0	45,0	5,5	—	119	366	2517	8,2	166,00
TB 120 H 100*	120	7A	GG	485,10	483,73	—	34,0	45,0	45,0	5,5	—	119	462	2517	12,1	224,00

Type H – Teilung Pitch 12,7 mm für Riemenbreite for belt width 150

TB 18 H 150	18	5F	St	72,77	71,39	79	45,0	45,0	25,0	—	20,0	—	53	1210	0,6	34,70
TB 19 H 150	19	5F	St	76,81	75,44	83	45,0	45,0	25,0	—	20,0	—	56	1210	0,7	36,00
TB 20 H 150	20	5F	St	80,55	79,48	87	45,0	45,0	25,0	—	20,0	—	60	1210	0,8	37,20
TB 21 H 150	21	5F	GG	84,89	83,52	91	45,0	45,0	25,0	—	20,0	—	64	1210	1,0	38,50
TB 22 H 150	22	5F	GG	88,94	87,56	93	45,0	45,0	25,0	—	20,0	—	68	1210	1,2	39,80
TB 23 H 150	23	5F	GG	92,98	91,61	97	45,0	45,0	25,0	—	20,0	—	71	1610	1,3	40,80
TB 24 H 150	24	5F	GG	97,02	95,65	103	45,0	45,0	25,0	—	20,0	—	74	1610	1,2	41,70
TB 25 H 150	25	5F	GG	101,06	99,69	106	45,0	45,0	25,0	—	20,0	—	78	1610	1,2	44,30
TB 26 H 150	26	5F	GG	105,11	103,73	111	45,0	45,0	25,0	—	20,0	—	82	1610	1,4	46,90
TB 27 H 150	27	5F	GG	109,15	107,78	115	45,0	45,0	25,0	—	20,0	—	87	1610	1,6	49,10
TB 28 H 150	28	5F	GG	113,19	111,82	119	45,0	45,0	25,0	—	20,0	—	91	1610	1,8	51,00
TB 30 H 150	30	5F	GG	121,28	119,90	127	45,0	45,0	25,0	—	20,0	—	99	1610	2,0	55,50
TB 32 H 150	32	5WF	GG	129,36	127,99	135	45,0	45,0	25,0	—	20,0	92	108	1610	2,3	61,00
TB 36 H 150	36	5WF	GG	145,53	144,16	152	45,0	45,0	25,0	—	20,0	92	124	1610	3,1	71,30
TB 40 H 150	40	5WF	GG	161,70	160,33	168	45,0	45,0	25,0	—	20,0	92	140	1610	4,0	78,00
TB 44 H 150	44	5WF	GG	177,87	176,50	184	45,0	45,0	32,0	—	13,0	106	153	2012	4,4	90,80
TB 48 H 150	48	5WF	GG	194,04	192,67	200	45,0	45,0	32,0	—	13,0	106	169	2012	4,8	100,00
TB 60 H 150	60	9A	GG	242,55	241,18	—	46,0	46,0	32,0	—	7,0	106	223	2012	5,4	108,00
TB 72 H 150	72	9A	GG	291,06	289,69	—	46,0	46,0	32,0	—	7,0	106	270	2012	6,5	124,00
TB 84 H 150*	84	9A	GG	339,57	338,20	—	46,0	46,0	32,0	—	7,0	106	320	2012	8,4	146,00
TB 96 H 150*	96	9A	GG	388,08	386,71	—	46,0	46,0	45,0	—	0,5	119	366	2517	11,0	192,00
TB 120 H 150*	120	9A	GG	485,10	483,73	—	46,0	46,0	45,0	—	0,5	119	462	2517	14,8	240,00

Taper-Buchse Taper bush	1108	1210	1610	2012	2517
Bohrung d ₂ (mm) von ... bis ... Bore d ₂ (mm) from ... to ...	10-28	11-32	14-42	14-50	16-60
€/Stück each	7,00	9,20	11,00	13,50	16,90

St = Stahl Steel – GG = Grauguss Cast iron
Fertigungstechnische Änderungen vorbehalten.
We reserve the right to make technical changes.

* Keine Lagerware Non stock items

Bohrungsdurchmesser d₂ siehe Seite 3.
Bore diameters d₂ see page 3.

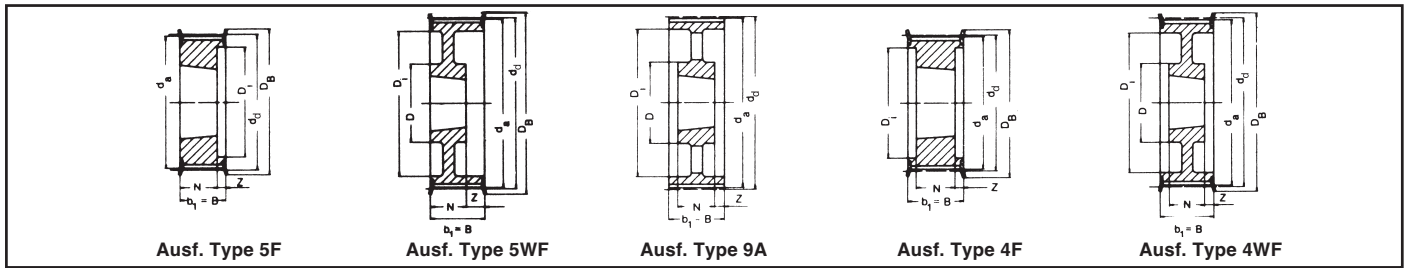

Type H – Teilung Pitch 12,7 mm für Riemenbreite for belt width 200

Bezeichnung Part No.	Anzahl der Zähne No. of teeth	Aus- führung Type	Mate- rial	d _d (mm)	d _a (mm)	D _B (mm)	b ₁ (mm)	B (mm)	N (mm)	V (mm)	Z (mm)	D (mm)	D ₁ (mm)	Taper- Buchse Taper bush	Gewicht ohne Buchse Weight without bush (= kg)	€ Stück ohne Buchse each without bush
TB 18 H 200	18	5F	St	72,77	71,39	79	58,0	58,0	25,0	—	33,0	—	52	1210	0,8	38,20
TB 19 H 200	19	5F	St	76,81	75,44	83	58,0	58,0	25,0	—	33,0	—	56	1610	0,9	40,50
TB 20 H 200	20	5F	St	80,55	79,48	87	58,0	58,0	25,0	—	33,0	—	60	1610	1,0	43,00
TB 21 H 200	21	5F	GG	84,89	83,52	91	58,0	58,0	25,0	—	33,0	—	64	1610	1,7	44,60
TB 22 H 200	22	5F	GG	88,94	87,56	93	58,0	58,0	25,0	—	33,0	—	68	1610	1,5	46,60
TB 23 H 200	23	5F	GG	92,98	91,61	97	58,0	58,0	25,0	—	33,0	—	71	1610	1,8	48,20
TB 24 H 200	24	5F	GG	97,02	95,65	103	58,0	58,0	25,0	—	33,0	—	74	1610	1,5	49,80
TB 25 H 200	25	5F	GG	101,06	99,69	106	58,0	58,0	25,0	—	33,0	—	78	1610	1,5	52,00
TB 26 H 200	26	5F	GG	105,11	103,73	111	58,0	58,0	25,0	—	33,0	—	82	1610	1,8	54,90
TB 27 H 200	27	5F	GG	109,15	107,78	115	58,0	58,0	25,0	—	33,0	—	87	1610	1,9	57,50
TB 28 H 200	28	5F	GG	113,19	111,82	119	58,0	58,0	25,0	—	33,0	—	91	1610	1,9	60,40
TB 30 H 200	30	5F	GG	121,28	119,90	127	58,0	58,0	25,0	—	33,0	—	99	1610	2,3	66,10
TB 32 H 200	32	5F	GG	129,36	127,99	135	58,0	58,0	32,0	—	26,0	—	107	2012	3,0	72,90
TB 36 H 200	36	5WF	GG	145,53	144,16	152	58,0	58,0	32,0	—	26,0	102	124	2012	3,0	85,70
TB 40 H 200	40	5WF	GG	161,70	160,33	168	58,0	58,0	32,0	—	26,0	106	140	2012	3,6	97,60
TB 44 H 200	44	5WF	GG	177,87	176,50	184	58,0	58,0	32,0	—	26,0	106	153	2012	4,5	104,00
TB 48 H 200	48	5WF	GG	194,04	192,67	200	58,0	58,0	45,0	—	13,0	119	169	2517	4,6	119,00
TB 60 H 200	60	9A	GG	242,55	241,18	—	60,0	60,0	45,0	—	7,5	119	223	2517	7,0	133,00
TB 72 H 200	72	9A	GG	291,06	289,69	—	60,0	60,0	45,0	—	7,5	119	270	2517	8,0	149,00
TB 84 H 200*	84	9A	GG	339,57	338,20	—	60,0	60,0	45,0	—	7,5	119	320	2517	9,0	169,00
TB 96 H 200*	96	9A	GG	388,08	386,71	—	60,0	60,0	45,0	—	7,5	119	366	2517	11,5	211,00
TB 120 H 200*	120	9A	GG	485,10	483,73	—	60,0	60,0	45,0	—	7,5	119	462	2517	15,4	286,00

Type H – Teilung Pitch 12,7 mm für Riemenbreite for belt width 300

TB 20 H 300	20	4F	St	80,55	79,48	87	84,0	84,0	38,0	—	23,0	—	65	1615	1,5	57,80
TB 21 H 300	21	4F	GG	84,89	83,52	91	84,0	84,0	38,0	—	23,0	—	66	1615	1,2	59,10
TB 22 H 300	22	4F	GG	88,94	87,56	93	84,0	84,0	38,0	—	23,0	—	67	1615	1,6	60,40
TB 23 H 300	23	4F	GG	92,98	91,61	97	84,0	84,0	38,0	—	23,0	—	71	1615	1,8	61,60
TB 24 H 300	24	4F	GG	97,02	95,65	103	84,0	84,0	38,0	—	23,0	—	75	1615	2,1	63,20
TB 25 H 300	25	4F	GG	101,06	99,69	106	84,0	84,0	38,0	—	23,0	—	79	1615	2,0	66,80
TB 26 H 300	26	4F	GG	105,11	103,73	111	84,0	84,0	38,0	—	23,0	—	83	1615	2,7	70,30
TB 27 H 300	27	4F	GG	109,15	107,78	115	84,0	84,0	32,0	—	26,0	—	87	2012	3,0	74,20
TB 28 H 300	28	4F	GG	113,19	111,82	119	84,0	84,0	32,0	—	26,0	—	91	2012	2,4	77,70
TB 30 H 300	30	4F	GG	121,28	119,90	127	84,0	84,0	32,0	—	26,0	—	99	2012	2,9	84,10
TB 32 H 300	32	4F	GG	129,36	127,99	135	84,0	84,0	45,0	—	19,5	—	107	2517	3,3	94,10
TB 36 H 300	36	4F	GG	145,53	144,16	152	84,0	84,0	45,0	—	19,5	—	124	2517	4,5	108,00
TB 40 H 300	40	4F	GG	161,70	160,33	168	84,0	84,0	45,0	—	19,5	—	137	2517	6,0	119,00
TB 44 H 300	44	4WF	GG	177,87	176,50	184	86,0	86,0	45,0	—	20,5	119	153	2517	6,6	137,00
TB 48 H 300	48	4WF	GG	194,04	192,67	200	86,0	86,0	45,0	—	20,5	119	169	2517	7,6	149,00
TB 60 H 300	60	9A	GG	242,55	241,18	—	86,0	86,0	45,0	—	20,5	119	223	2517	8,4	175,00
TB 72 H 300	72	9A	GG	291,06	289,69	—	86,0	86,0	45,0	—	20,5	119	270	2517	10,4	200,00
TB 84 H 300*	84	9A	GG	339,57	338,20	—	86,0	86,0	45,0	—	20,5	119	320	2517	12,5	240,00
TB 96 H 300*	96	9A	GG	388,08	386,71	—	86,0	86,0	76,0	—	5,0	150	362	3030	14,2	339,00
TB 120 H 300*	120	9A	GG	485,10	483,73	—	86,0	86,0	76,0	—	5,0	150	460	3030	18,8	430,00

Taper-Buchse Taper bush	1210	1610	1615	2012	2517	3030
Bohrung d ₂ (mm) von ... bis ... Bore d ₂ (mm) from ... to ...	11-32	14-42	14-42	14-50	16-60	35-75
€/Stück each	9,20	11,00	11,50	13,50	16,90	28,80

St = Stahl Steel – GG = Grauguss Cast iron
Fertigungstechnische Änderungen vorbehalten.
We reserve the right to make technical changes.
* Keine Lagerware Non stock items
Bohrungsdurchmesser d₂ siehe Seite 3.
Bore diameters d₂ see page 3.

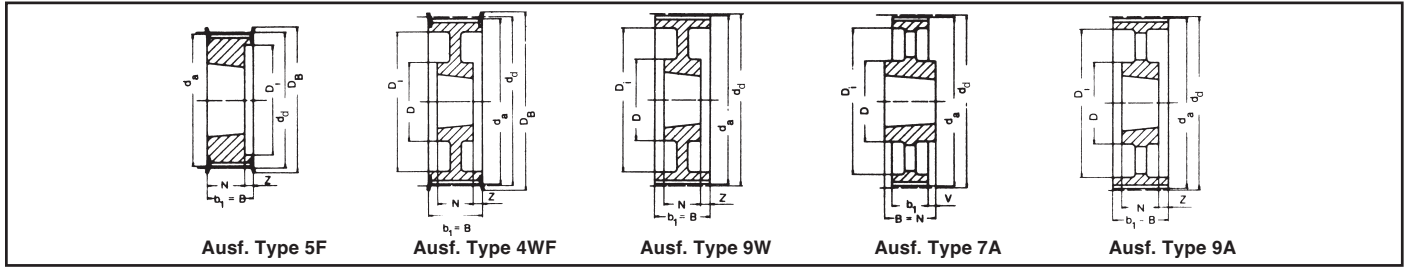

Type XH – Teilung Pitch 22,225 mm für Riemenbreite for belt width 200

Bezeichnung Part No.	Anzahl der Zähne No. of teeth	Aus- führung Type	Mate- rial	d _d (mm)	d _a (mm)	D _B (mm)	b ₁ (mm)	B (mm)	N (mm)	V (mm)	Z (mm)	D (mm)	D ₁ (mm)	Taper- Buchse Taper bush	Gewicht ohne Buchse Weight without bush (= kg)	€ Stück ohne Buchse each without bush
TB 18 XH 200*	18	5F	GG	127,34	124,55	138	64	64	45	—	20,0	—	95	2517	2,6	332,00
TB 20 XH 200*	20	5F	GG	141,49	138,69	154	64	64	45	—	20,0	—	110	2517	3,6	360,00
TB 22 XH 200*	22	5F	GG	155,64	152,84	168	64	64	45	—	20,0	—	120	2517	4,8	383,00
TB 24 XH 200*	24	5F	GG	169,79	166,69	183	64	64	45	—	20,0	—	135	2517	6,1	433,00
TB 26 XH 200*	26	5F	GG	183,94	181,14	198	64	64	45	—	20,0	—	150	2517	7,4	462,00
TB 28 XH 200*	28	4WF	GG	198,08	195,29	211	64	64	45	—	10,0	120	165	2517	9,0	501,00
TB 30 XH 200*	30	4WF	GG	212,23	209,44	226	64	64	45	—	10,0	120	180	2517	8,6	554,00
TB 32 XH 200*	32	4WF	GG	226,38	223,59	240	64	64	45	—	10,0	120	195	2517	9,8	583,00
TB 40 XH 200*	40	4WF	GG	282,98	280,18	296	64	64	51	—	6,5	160	245	3020	13,3	799,00
TB 48 XH 200*	48	9W	GG	339,57	336,78	—	64	64	51	—	6,5	160	300	3020	19,0	1.083,00

Type XH – Teilung Pitch 22,225 mm für Riemenbreite for belt width 300

TB 18 XH 300*	18	5F	GG	127,34	124,55	138	90	90	45	—	45,0	—	95	2517	3,7	427,00
TB 20 XH 300*	20	5F	GG	141,49	138,69	154	90	90	45	—	45,0	—	110	2517	4,7	482,00
TB 22 XH 300*	22	5F	GG	155,64	152,84	168	90	90	45	—	45,0	—	120	2517	6,0	504,00
TB 24 XH 300*	24	5F	GG	169,79	166,69	183	90	90	45	—	45,0	—	135	2517	7,6	565,00
TB 26 XH 300*	26	5F	GG	183,94	181,14	198	90	90	45	—	45,0	—	150	2517	9,8	607,00
TB 28 XH 300*	28	5F	GG	198,08	195,29	211	90	90	51	—	39,0	—	165	3020	11,6	677,00
TB 30 XH 300*	30	5F	GG	212,23	209,44	226	90	90	51	—	39,0	—	180	3020	11,9	744,00
TB 32 XH 300*	32	5F	GG	226,38	223,59	240	90	90	51	—	39,0	—	195	3020	13,8	774,00
TB 40 XH 300*	40	4WF	GG	282,98	280,18	296	90	90	51	—	19,5	160	245	3020	19,5	1.014,00
TB 48 XH 300*	48	9W	GG	339,57	336,78	—	90	90	51	—	19,5	160	300	3020	27,0	1.178,00

Taper-Buchse Taper bush	2517	3020	3535	4040
Bohrung d ₂ (mm) von ... bis ... Bore d ₂ (mm) from ... to ...	16-60	25-75	35-90	40-100
€/Stück each	16,90	22,00	55,50	78,00

GG = Grauguss Cast iron
Fertigungstechnische Änderungen vorbehalten.
We reserve the right to make technical changes.
* Keine Lagerware Non stock items
Bohrungsdurchmesser d₂ siehe Seite 3.
Bore diameters d₂ see page 3.

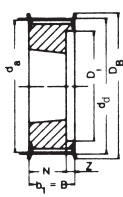

Ausf. Type 5F

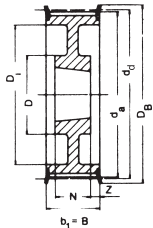

Ausf. Type 4WF

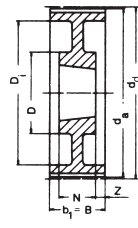

Ausf. Type 9W

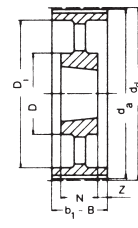

Ausf. Type 9A

Type XH – Teilung Pitch 22,225 mm für Riemenbreite for belt width 400

Bezeichnung Part No.	Anzahl der Zähne No. of teeth	Aus- führung Type	Mate- rial	d _d (mm)	d _a (mm)	D _B (mm)	b ₁ (mm)	B (mm)	N (mm)	V (mm)	Z (mm)	D (mm)	D ₁ (mm)	Taper- Buchse Taper bush	Gewicht ohne Buchse Weight without bush (= kg)	€ Stück ohne Buchse each without bush
TB 20 XH 400*	20	5F	GG	141,49	138,69	154	119	119	45	—	74,0	—	110	2517	6,0	520,00
TB 22 XH 400*	22	5F	GG	155,64	152,84	168	119	119	45	—	74,0	—	120	2517	7,2	576,00
TB 24 XH 400*	24	5F	GG	169,79	166,69	183	119	119	51	—	68,0	—	135	3020	8,4	615,00
TB 26 XH 400*	26	5F	GG	183,94	181,14	198	119	119	51	—	68,0	—	150	3020	10,3	718,00
TB 28 XH 400*	28	5F	GG	198,08	195,29	211	119	119	51	—	68,0	—	165	3020	12,3	768,00
TB 30 XH 400*	30	5F	GG	212,23	209,44	226	119	119	51	—	68,0	—	180	3020	14,3	817,00
TB 32 XH 400*	32	5F	GG	226,38	223,59	240	119	119	51	—	68,0	—	195	3020	19,9	893,00
TB 40 XH 400*	40	4WF	GG	282,98	280,18	296	119	119	89	—	15,0	190	245	3535	24,6	953,00
TB 48 XH 400*	48	9W	GG	339,57	336,78	—	119	119	89	—	15,0	190	300	3535	30,0	1.221,00

Taper-Buchse Taper bush	2517	3020	3535	4040
Bohrung d ₂ (mm) von ... bis ... Bore d ₂ (mm) from ... to ...	16-60	25-75	35-90	40-100
€/Stück each	16,90	22,00	55,50	78,00

GG = Grauguss Cast iron
Fertigungstechnische Änderungen vorbehalten.
We reserve the right to make technical changes.
* Keine Lagerware Non stock items
Bohrungsdurchmesser d₂ siehe Seite 3.
Bore diameters d₂ see page 3.

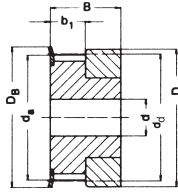

Ausf. Type 1F

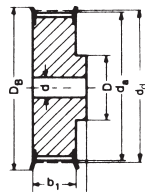

Ausf. Type 6F

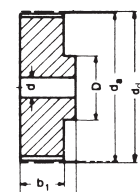

Ausf. Type 6

Type 3M – Teilung Pitch 3 mm für Riemenbreite for belt width 6 mm

Keine Lagerware
 Non stock items

Bezeichnung Part No.	Anzahl der Zähne No. of teeth	Aus- führung Type	Material	d _d (mm)	d _a (mm)	D _B (mm)	b ₁ (mm)	B (mm)	D (mm)	Vor- bohrung Pilot bore d (mm)	Fertig- bohrung Finished bore d _{max} (mm)	Gewicht Weight (= kg)	€ Stück each
10-3M-6	10	1F	Al	9,55	8,79	13,0	7,2	14,5	13,0	—	3		auf Anfrage on request
12-3M-6	12	1F	Al	11,46	10,70	15,0	7,2	14,5	15,0	—	5		
14-3M-6	14	1F	Al	13,37	12,61	16,0	7,2	14,5	16,0	—	6		
15-3M-6	15	1F	Al	14,32	13,56	17,5	7,2	14,5	17,5	—	6		
16-3M-6	16	6F	Al	15,28	14,52	18,0	9,8	17,5	10,0	4	7		
18-3M-6	18	6F	Al	17,19	16,43	19,5	9,8	17,5	11,0	6	8		
20-3M-6	20	6F	Al	19,10	18,34	23,0	9,8	17,5	13,0	6	9		
21-3M-6	21	6F	Al	20,05	19,29	25,0	9,8	17,5	14,0	6	9		
22-3M-6	22	6F	Al	21,01	20,25	25,0	9,8	17,5	14,0	6	9		
24-3M-6	24	6F	Al	22,92	22,16	25,0	9,8	17,5	14,0	6	9		
26-3M-6	26	6F	Al	24,83	24,07	28,0	9,8	17,5	16,0	6	11		
28-3M-6	28	6F	Al	26,74	25,98	32,0	9,8	17,5	18,0	6	12		
30-3M-6	30	6F	Al	28,65	27,89	32,0	9,8	17,5	20,0	6	14		
32-3M-6	32	6F	Al	30,56	29,80	36,0	9,8	17,5	22,0	6	15		
36-3M-6	36	6F	Al	34,38	33,62	38,0	10,3	18,0	26,0	6	16		
40-3M-6	40	6F	Al	38,20	37,44	42,0	10,3	18,0	28,0	6	18		
44-3M-6	44	6F	Al	42,02	41,26	48,0	10,3	18,0	33,0	6	20		
48-3M-6	48	6	Al	45,84	45,08	—	10,3	18,6	33,0	8	20		
60-3M-6	60	6	Al	57,30	56,54	—	10,3	18,6	33,0	8	20		
72-3M-6	72	6	Al	68,75	67,99	—	10,3	18,6	33,0	8	20		

Type 3M – Teilung Pitch 3 mm für Riemenbreite for belt width 9 mm

10-3M-9	10	1F	Al	9,55	8,79	13,0	10,2	17,5	13,0	—	3	0,004	8,70
12-3M-9	12	1F	Al	11,46	10,70	15,0	10,2	17,5	15,0	—	5	0,006	9,00
14-3M-9	14	1F	Al	13,37	12,61	16,0	10,2	17,5	16,0	—	6	0,007	9,30
15-3M-9	15	1F	Al	14,32	13,56	17,5	10,2	17,5	17,5	—	6	0,008	9,60
16-3M-9	16	6F	Al	15,28	14,52	18,0	12,8	20,6	10,0	4	7	0,007	10,30
18-3M-9	18	6F	Al	17,19	16,43	19,5	12,8	20,6	11,0	6	8	0,008	11,60
20-3M-9	20	6F	Al	19,10	18,34	23,0	12,8	20,6	13,0	6	9	0,010	11,90
21-3M-9	21	6F	Al	20,05	19,29	25,0	12,8	20,6	14,0	6	9	0,013	12,20
22-3M-9	22	6F	Al	21,01	20,25	25,0	12,8	20,6	14,0	6	9	0,014	13,20
24-3M-9	24	6F	Al	22,92	22,16	25,0	12,8	20,6	14,0	6	9	0,016	13,50
26-3M-9	26	6F	Al	24,83	24,07	28,0	12,8	20,6	16,0	6	11	0,018	14,50
28-3M-9	28	6F	Al	26,74	25,98	32,0	12,8	20,6	18,0	6	12	0,024	15,10
30-3M-9	30	6F	Al	28,65	27,89	32,0	12,8	20,6	20,0	6	14	0,028	15,70
32-3M-9	32	6F	Al	30,56	29,80	36,0	12,8	20,6	22,0	6	15	0,032	16,40
36-3M-9	36	6F	Al	34,38	33,62	38,0	13,4	22,2	26,0	6	16	0,045	18,00
40-3M-9	40	6F	Al	38,20	37,44	42,0	13,4	22,2	28,0	6	18	0,055	18,30
44-3M-9	44	6F	Al	42,02	41,26	48,0	13,4	22,2	33,0	6	20	0,074	22,20
48-3M-9	48	6	Al	45,84	45,08	—	13,4	22,2	33,0	8	20	0,074	23,80
60-3M-9	60	6	Al	57,30	56,54	—	13,4	22,2	33,0	8	20	0,106	28,60
72-3M-9	72	6	Al	68,75	67,99	—	13,4	22,2	33,0	8	20	0,145	36,00

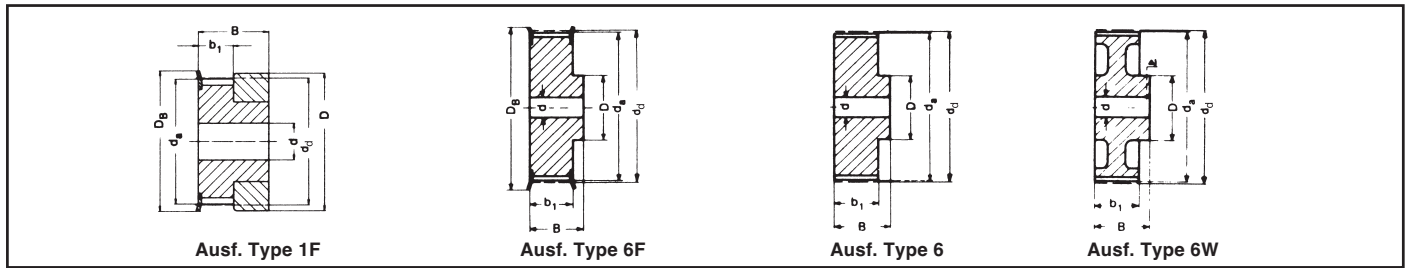

Type 3M – Teilung Pitch 3 mm für Riemenbreite for belt width 15 mm

Bezeichnung Part No.	Anzahl der Zähne No. of teeth	Aus- führung Type	Material	d _d (mm)	d _a (mm)	D _B (mm)	b ₁ (mm)	B (mm)	D (mm)	Vor- bohrung Pilot bore d (mm)	Fertig- bohrung Finished bore d _{max} (mm)	Gewicht Weight (= kg)	€ Stück each
10-3M-15	10	1F	Al	9,55	8,79	13,0	17,0	26	13,0	—	3	0,006	9,60
12-3M-15	12	1F	Al	11,46	10,70	15,0	17,0	26	15,0	—	5	0,008	10,00
14-3M-15	14	1F	Al	13,37	12,61	16,0	17,0	26	16,0	—	6	0,010	10,90
15-3M-15	15	1F	Al	14,32	13,56	17,5	17,0	26	17,5	—	6	0,012	11,20
16-3M-15	16	6F	Al	15,28	14,52	18,0	19,5	26	10,0	4	7	0,010	11,90
18-3M-15	18	6F	Al	17,19	16,43	19,5	19,5	26	11,0	6	8	0,012	12,20
20-3M-15	20	6F	Al	19,10	18,34	23,0	19,5	26	13,0	6	9	0,014	12,80
21-3M-15	21	6F	Al	20,05	19,29	25,0	19,5	26	14,0	6	9	0,016	13,20
22-3M-15	22	6F	Al	21,01	20,25	25,0	19,5	26	14,0	6	9	0,018	14,50
24-3M-15	24	6F	Al	22,92	22,16	25,0	19,5	26	14,0	6	9	0,020	15,10
26-3M-15	26	6F	Al	24,83	24,07	28,0	19,5	26	16,0	6	11	0,027	15,70
28-3M-15	28	6F	Al	26,74	25,98	32,0	19,5	26	18,0	6	12	0,030	16,10
30-3M-15	30	6F	Al	28,65	27,89	32,0	19,5	26	20,0	6	14	0,035	17,30
32-3M-15	32	6F	Al	30,56	29,80	36,0	19,5	26	22,0	6	15	0,042	18,60
36-3M-15	36	6F	Al	34,38	33,62	38,0	20,0	30	26,0	6	16	0,060	21,50
40-3M-15	40	6F	Al	38,20	37,44	42,0	20,0	30	28,0	6	18	0,075	21,80
44-3M-15	44	6F	Al	42,02	41,26	48,0	20,0	30	33,0	6	20	0,100	25,70
48-3M-15	48	6	Al	45,84	45,08	—	20,0	30	33,0	8	20	0,103	28,30
60-3M-15	60	6	Al	57,30	56,54	—	20,0	30	33,0	8	20	0,150	34,70
72-3M-15	72	6	Al	68,75	67,99	—	20,0	30	33,0	8	20	0,212	41,70

Type 5M – Teilung Pitch 5 mm für Riemenbreite for belt width 9 mm

12-5M-9	12	6F	St	19,10	17,96	23	14,5	20,0	13,0	4	7	0,028	9,30
14-5M-9	14	6F	St	22,28	21,14	25	14,5	20,0	14,0	6	8	0,034	10,00
15-5M-9	15	6F	St	23,87	22,73	28	14,5	20,0	16,0	6	10	0,042	10,30
16-5M-9	16	6F	St	25,46	24,32	28	14,5	20,0	16,5	6	10	0,050	10,90
18-5M-9	18	6F	St	28,65	27,51	32	14,5	20,0	20,0	6	12	0,070	11,90
20-5M-9	20	6F	St	31,83	30,69	36	14,5	22,5	23,0	6	14	0,094	12,80
21-5M-9	21	6F	St	33,42	32,28	38	14,5	22,5	24,0	6	14	0,110	13,50
22-5M-9	22	6F	St	35,01	33,87	38	14,5	22,5	25,5	6	14	0,118	14,10
24-5M-9	24	6F	St	38,20	37,06	42	14,5	22,5	27,0	6	16	0,145	14,80
26-5M-9	26	6F	St	41,38	40,24	44	14,5	22,5	30,0	6	18	0,170	15,40
28-5M-9	28	6F	St	44,56	43,42	48	14,5	22,5	30,5	6	18	0,200	16,10
30-5M-9	30	6F	St	47,75	46,61	51	14,5	22,5	35,0	6	20	0,236	16,70
32-5M-9	32	6F	St	50,93	49,79	54	14,5	22,5	38,0	8	22	0,270	18,00
36-5M-9	36	6F	St	57,30	56,16	60	14,5	22,5	38,0	8	22	0,324	19,60
40-5M-9	40	6F	St	63,66	62,52	71	14,5	22,5	38,0	8	22	0,400	20,50
44-5M-9	44	6W	Al	70,03	68,89	—	14,5	25,5	38,0	8	22	0,170	24,40
48-5M-9	48	6W	Al	76,39	75,25	—	14,5	25,5	45,0	8	25	0,182	26,30
60-5M-9	60	6W	Al	95,49	94,35	—	14,5	25,5	45,0	8	25	0,230	33,10
72-5M-9	72	6W	Al	114,59	113,45	—	14,5	25,5	45,0	8	25	0,270	39,80

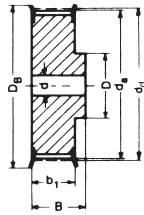

Ausf. Type 6F

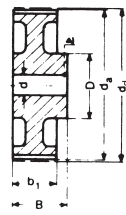

Ausf. Type 6W

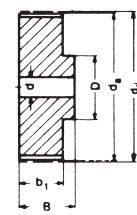

Ausf. Type 6

Type 5M – Teilung Pitch 5 mm für Riemenbreite for belt width 15 mm

Bezeichnung Part No.	Anzahl der Zähne No. of teeth	Aus- führung Type	Material	d _d (mm)	d _a (mm)	D _B (mm)	b ₁ (mm)	B (mm)	D (mm)	Vor- bohrung Pilot bore d (mm)	Fertig- bohrung Finished bore d _{max} (mm)	Gewicht Weight (= kg)	€ Stück each
12-5M-15	12	6F	St	19,10	17,96	25	20,5	26	13,0	4	7	0,034	10,60
14-5M-15	14	6F	St	22,28	21,14	25	20,5	26	14,0	6	8	0,046	11,20
15-5M-15	15	6F	St	23,87	22,73	28	20,5	26	16,0	6	10	0,056	11,90
16-5M-15	16	6F	St	25,46	24,32	28	20,5	26	16,5	6	10	0,064	12,80
18-5M-15	18	6F	St	28,65	27,51	32	20,5	26	20,0	6	12	0,086	13,50
20-5M-15	20	6F	St	31,83	30,69	36	20,5	26	23,0	6	14	0,112	14,10
21-5M-15	21	6F	St	33,42	32,28	38	20,5	26	24,0	6	14	0,130	15,10
22-5M-15	22	6F	St	35,01	33,87	38	20,5	26	25,5	6	14	0,140	15,70
24-5M-15	24	6F	St	38,20	37,06	42	20,5	28	27,0	6	16	0,180	16,70
26-5M-15	26	6F	St	41,38	40,24	44	20,5	28	30,0	6	18	0,220	17,00
28-5M-15	28	6F	St	44,56	43,42	48	20,5	28	30,5	6	18	0,250	18,00
30-5M-15	30	6F	St	47,75	46,61	51	20,5	28	35,0	6	20	0,300	19,60
32-5M-15	32	6F	St	50,93	49,79	54	20,5	28	38,0	8	22	0,350	21,20
36-5M-15	36	6F	St	57,30	56,16	60	20,5	28	38,0	8	22	0,426	22,50
40-5M-15	40	6F	St	63,66	62,52	71	20,5	28	38,0	8	22	0,520	24,10
44-5M-15	44	6W	Al	70,03	68,89	—	20,5	30	38,0	8	22	0,225	28,30
48-5M-15	48	6W	Al	76,39	75,25	—	20,5	30	38,0	8	25	0,187	31,50
60-5M-15	60	6W	Al	95,49	94,35	—	20,5	30	50,0	8	25	0,305	38,80
72-5M-15	72	6W	Al	114,59	113,45	—	20,5	30	50,0	8	25	0,375	46,60

Type 5M – Teilung Pitch 5 mm für Riemenbreite for belt width 25 mm

12-5M-25	12	6F	St	19,10	17,96	25	30	36	13,0	4	7	0,050	13,20
14-5M-25	14	6F	St	22,28	21,14	25	30	36	14,0	6	8	0,070	14,10
15-5M-25	15	6F	St	23,87	22,73	28	30	36	16,0	6	10	0,080	14,80
16-5M-25	16	6F	St	25,46	24,32	28	30	36	16,5	6	10	0,100	15,40
18-5M-25	18	6F	St	28,65	27,51	32	30	36	20,0	6	12	0,120	16,10
20-5M-25	20	6F	St	31,83	30,69	36	30	36	23,0	6	14	0,160	16,70
21-5M-25	21	6F	St	33,42	32,28	38	30	38	24,0	6	14	0,190	17,70
22-5M-25	22	6F	St	35,01	33,87	38	30	38	25,5	6	14	0,210	18,60
24-5M-25	24	6F	St	38,20	37,06	42	30	38	27,0	6	16	0,250	20,20
26-5M-25	26	6F	St	41,38	40,24	44	30	38	30,0	6	18	0,300	21,80
28-5M-25	28	6F	St	44,56	43,42	48	30	38	30,5	6	18	0,350	23,10
30-5M-25	30	6F	St	47,75	46,61	51	30	38	35,0	6	20	0,420	25,40
32-5M-25	32	6F	St	50,93	49,79	54	30	38	38,0	8	22	0,480	27,30
36-5M-25	36	6F	St	57,30	56,16	60	30	38	38,0	8	22	0,590	28,90
40-5M-25	40	6F	St	63,66	62,52	71	30	38	38,0	8	22	0,740	33,10
44-5M-25	44	6W	Al	70,03	68,89	—	30	40	38,0	8	22	0,320	39,80
48-5M-25	48	6W	Al	76,39	75,25	—	30	40	38,0	8	25	0,275	43,00
60-5M-25	60	6W	Al	95,49	94,35	—	30	40	50,0	8	25	0,435	53,60
72-5M-25	72	6W	Al	114,59	113,45	—	30	40	50,0	8	25	0,525	63,90

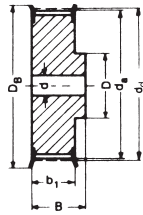

Ausf. Type 6F

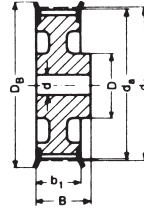

Ausf. Type 6WF

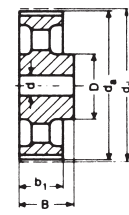

Ausf. Type 6A

Type 8M – Teilung Pitch 8 mm für Riemenbreite for belt width 20 mm

Bezeichnung Part No.	Anzahl der Zähne No. of teeth	Aus- führung Type	Material	d _d (mm)	d _a (mm)	D _B (mm)	b ₁ (mm)	B (mm)	D (mm)	D _i (mm)	Vor- bohrung Pilot bore d (mm)	Fertig- bohrung Finished bore d _{max} (mm)	Gewicht Weight (≈ kg)	€ Stück each
22-8M-20	22	6F	St	56,02	54,65	60,0	28	38	43	—	12	30	0,54	21,50
24-8M-20	24	6F	St	61,12	59,75	66,0	28	38	45	—	12	30	0,65	23,10
26-8M-20	26	6F	St	66,21	64,84	71,0	28	38	50	—	12	35	0,80	24,70
28-8M-20	28	6F	St	71,30	70,08	75,0	28	38	50	—	15	35	0,87	26,30
30-8M-20	30	6F	St	76,39	75,13	83,0	28	38	55	—	15	35	1,02	27,90
32-8M-20	32	6F	St	81,49	80,16	87,0	28	38	60	—	15	40	1,20	30,50
34-8M-20	34	6F	St	86,58	85,22	91,0	28	38	70	—	15	45	1,40	32,40
36-8M-20	36	6F	St	91,67	90,30	98,5	28	38	70	—	15	45	1,55	34,00
38-8M-20	38	6F	St	96,77	95,39	103,0	28	38	75	—	15	45	1,65	36,60
40-8M-20	40	6F	GG	101,86	100,49	106,0	28	38	75	—	15	45	1,80	39,80
44-8M-20	44	6F	GG	112,05	110,67	119,0	28	38	75	—	15	45	2,10	46,60
48-8M-20	48	6F	GG	122,23	120,86	127,0	28	38	75	—	15	45	2,44	51,00
56-8M-20	56	6WF	GG	142,60	141,23	148,0	28	38	80	117	15	45	2,60	66,10
64-8M-20	64	6WF	GG	162,97	161,60	168,0	28	38	80	137	15	45	2,90	77,70
72-8M-20	72	6WF	GG	183,35	181,97	192,0	28	38	80	158	15	45	3,10	87,30
80-8M-20	80	6A	GG	203,72	202,35	—	28	38	90	180	15	50	3,80	92,50
90-8M-20	90	6A	GG	229,18	227,81	—	28	38	90	204	15	50	4,20	108,00
112-8M-20	112	6A	GG	285,21	283,83	—	28	38	90	260	18	50	5,20	140,00
144-8M-20	144	6A	GG	366,69	365,32	—	28	38	90	341	20	50	7,50	178,00
168-8M-20	168	6A	GG	427,81	426,44	—	28	38	100	402	20	55	10,00	269,00
192-8M-20	192	6A	GG	488,92	487,55	—	28	38	100	463	20	55	14,40	325,00

Type 8M – Teilung Pitch 8 mm für Riemenbreite for belt width 30 mm

22-8M-30	22	6F	St	56,02	54,65	60,0	38	48	43	—	12	30	0,69	24,70
24-8M-30	24	6F	St	61,12	59,75	66,0	38	48	45	—	12	30	0,84	26,30
26-8M-30	26	6F	St	66,21	64,84	71,0	38	48	50	—	12	35	1,00	28,30
28-8M-30	28	6F	St	71,30	70,08	75,0	38	48	50	—	15	35	1,12	30,80
30-8M-30	30	6F	St	76,39	75,13	83,0	38	48	55	—	15	35	1,32	33,40
32-8M-30	32	6F	St	81,49	80,16	87,0	38	48	60	—	15	40	1,50	35,30
34-8M-30	34	6F	St	86,58	85,22	91,0	38	48	70	—	15	45	1,80	37,20
36-8M-30	36	6F	St	91,67	90,30	98,5	38	48	70	—	15	45	1,99	39,80
38-8M-30	38	6F	St	96,77	95,39	103,0	38	48	75	—	15	45	2,27	42,70
40-8M-30	40	6F	GG	101,86	100,49	106,0	38	48	75	—	15	45	2,40	46,60
44-8M-30	44	6F	GG	112,05	110,67	119,0	38	48	75	—	15	45	2,80	53,30
48-8M-30	48	6F	GG	122,23	120,86	127,0	38	48	75	—	15	45	3,20	59,40
56-8M-30	56	6WF	GG	142,60	141,23	148,0	38	48	90	117	15	50	3,60	78,70
64-8M-30	64	6WF	GG	162,97	161,60	168,0	38	48	90	137	15	50	4,30	89,20
72-8M-30	72	6WF	GG	183,35	181,97	192,0	38	48	95	158	15	50	4,80	99,20
80-8M-30	80	6A	GG	203,72	202,35	—	38	48	100	180	15	55	5,10	114,00
90-8M-30	90	6A	GG	229,18	227,81	—	38	48	100	204	15	55	5,70	127,00
112-8M-30	112	6A	GG	285,21	283,83	—	38	48	100	260	18	55	6,80	144,00
144-8M-30	144	6A	GG	366,69	365,32	—	38	48	100	341	20	55	9,30	182,00
168-8M-30	168	6A	GG	427,81	426,44	—	38	48	100	402	20	55	11,40	273,00
192-8M-30	192	6A	GG	488,92	487,55	—	38	48	100	463	20	55	16,00	331,00

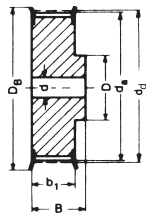

Ausf. Type 6F

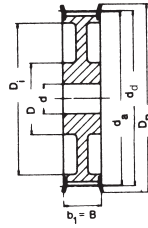

Ausf. Type 10WF

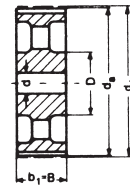

Ausf. Type 10A

Type 8M – Teilung Pitch 8 mm für Riemenbreite for belt width 50 mm

Bezeichnung Part No.	Anzahl der Zähne No. of teeth	Aus- führung Type	Material	d _d (mm)	d _a (mm)	D _B (mm)	b ₁ (mm)	B (mm)	D (mm)	D _i (mm)	Vor- bohrung Pilot bore d (mm)	Fertig- bohrung Finished bore d _{max} (mm)	Gewicht Weight (≈ kg)	€ Stück each
22-8M-50	22	6F	St	56,02	54,65	60,0	60	70	43	—	12	30	1,00	32,40
24-8M-50	24	6F	St	61,12	59,75	66,0	60	70	45	—	12	30	1,20	33,70
26-8M-50	26	6F	St	66,21	64,84	71,0	60	70	50	—	12	35	1,50	36,90
28-8M-50	28	6F	St	71,30	70,08	75,0	60	70	50	—	15	35	1,67	40,80
30-8M-50	30	6F	St	76,39	75,13	83,0	60	70	55	—	15	35	1,97	42,70
32-8M-50	32	6F	St	81,49	80,16	87,0	60	70	60	—	15	40	2,27	46,60
34-8M-50	34	6F	St	86,58	85,22	91,0	60	70	70	—	15	45	2,69	49,10
36-8M-50	36	6F	St	91,67	90,30	98,5	60	70	70	—	15	45	2,97	52,60
38-8M-50	38	6F	St	96,77	95,39	103,0	60	70	75	—	15	45	3,23	56,80
40-8M-50	40	6F	GG	101,86	100,49	106,0	60	70	75	—	18	45	3,50	59,40
44-8M-50	44	6F	GG	112,05	110,67	119,0	60	70	75	—	18	45	3,90	69,30
48-8M-50	48	6F	GG	122,23	120,86	127,0	60	70	80	—	18	45	4,30	78,00
56-8M-50	56	10WF	GG	142,60	141,23	148,0	60	60	90	117	18	50	5,00	95,70
64-8M-50	64	10WF	GG	162,97	161,60	168,0	60	60	100	137	18	55	5,60	112,00
72-8M-50	72	10WF	GG	183,35	181,97	192,0	60	60	100	158	18	55	6,80	119,00
80-8M-50	80	10A	GG	203,72	202,35	—	60	60	110	180	18	60	6,90	142,00
90-8M-50	90	10A	GG	229,18	227,81	—	60	60	110	204	18	60	8,60	166,00
112-8M-50	112	10A	GG	285,21	283,83	—	60	60	110	260	18	60	9,60	186,00
144-8M-50	144	10A	GG	366,69	365,32	—	60	60	110	341	20	60	13,80	254,00
168-8M-50	168	10A	GG	427,81	426,44	—	60	60	120	402	20	65	16,00	348,00
192-8M-50	192	10A	GG	488,92	487,55	—	60	60	130	463	20	70	22,40	446,00

Type 8M – Teilung Pitch 8 mm für Riemenbreite for belt width 85 mm

22-8M-85	22	6F	St	56,02	54,65	60,0	95	105	43	—	12	30	1,55	41,40
24-8M-85	24	6F	St	61,12	59,75	66,0	95	105	45	—	12	30	1,90	44,90
26-8M-85	26	6F	St	66,21	64,84	71,0	95	105	50	—	12	35	2,25	48,20
28-8M-85	28	6F	St	71,30	70,08	75,0	95	105	50	—	15	35	2,55	55,50
30-8M-85	30	6F	St	76,39	75,13	83,0	95	105	55	—	15	35	3,00	59,40
32-8M-85	32	6F	St	81,49	80,16	87,0	95	105	60	—	15	40	3,57	62,30
34-8M-85	34	6F	St	86,58	85,22	91,0	95	105	70	—	15	45	4,00	67,40
36-8M-85	36	6F	St	91,67	90,30	98,5	95	105	70	—	15	45	4,50	74,50
38-8M-85	38	6F	St	96,77	95,39	103,0	95	105	75	—	15	45	4,90	77,70
40-8M-85	40	6F	GG	101,86	100,49	106,0	95	105	75	—	18	45	5,20	85,70
44-8M-85	44	6F	GG	112,05	110,67	119,0	95	105	75	—	18	45	6,60	95,70
48-8M-85	48	6F	GG	122,23	120,86	127,0	95	105	80	—	18	45	7,60	109,00
56-8M-85	56	6F	GG	142,60	141,23	148,0	95	105	80	—	20	50	9,80	133,00
64-8M-85	64	10WF	GG	162,97	161,60	168,0	95	95	100	137	20	55	10,40	158,00
72-8M-85	72	10WF	GG	183,35	181,97	192,0	95	95	110	158	20	60	11,40	182,00
80-8M-85	80	10A	GG	203,72	202,35	—	95	95	110	180	20	60	11,10	194,00
90-8M-85	90	10A	GG	229,18	227,81	—	95	95	110	204	20	60	13,20	227,00
112-8M-85	112	10A	GG	285,21	283,83	—	95	95	110	260	24	60	16,30	285,00
144-8M-85*	144	10A	GG	366,69	365,32	—	95	95	120	341	24	65	21,50	426,00
168-8M-85*	168	10A	GG	427,81	426,44	—	95	95	120	402	24	65	26,10	457,00
192-8M-85*	192	10A	GG	488,92	487,55	—	95	95	130	463	24	70	30,60	578,00

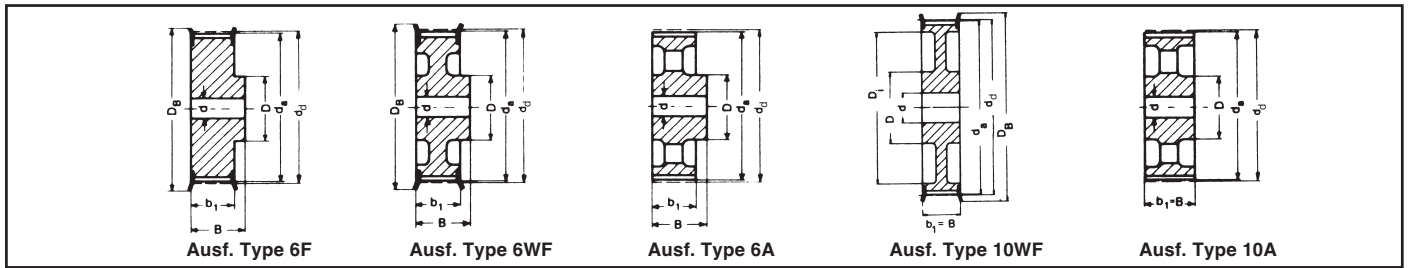

Type 14M – Teilung Pitch 14 mm für Riemenbreite for belt width 40 mm

Bezeichnung Part No.	Anzahl der Zähne No. of teeth	Aus- führung Type	Material	d _d (mm)	d _a (mm)	D _B (mm)	b ₁ (mm)	B (mm)	D (mm)	D _i (mm)	Vor- bohrung Pilot bore d (mm)	Fertig- bohrung Finished bore d _{max} (mm)	Gewicht Weight (≈ kg)	€ Stück each
28-14M-40	28	6F	GG	124,78	122,12	127	54	69	100	—	24	60	4,73	81,90
29-14M-40	29	6F	GG	129,23	126,57	138	54	69	100	—	24	60	5,09	88,30
30-14M-40	30	6F	GG	133,69	130,99	138	54	69	100	—	24	60	5,45	94,10
32-14M-40	32	6F	GG	142,60	139,88	154	54	69	100	—	24	70	6,17	101,00
34-14M-40	34	6F	GG	151,52	148,79	160	54	69	100	—	24	70	6,88	112,00
36-14M-40	36	6F	GG	160,43	157,68	168	54	69	100	—	24	70	7,60	122,00
38-14M-40	38	6F	GG	169,34	166,60	183	54	69	120	—	24	70	8,28	125,00
40-14M-40	40	6F	GG	178,25	175,49	188	54	69	120	—	24	70	9,26	141,00
44-14M-40	44	6F	GG	196,08	193,28	211	54	69	120	—	24	70	10,32	152,00
48-14M-40	48	6WF	GG	213,90	211,11	226	54	69	135	172	24	70	11,50	182,00
56-14M-40	56	6WF	GG	249,55	246,76	256	54	69	135	207	28	70	13,05	207,00
64-14M-40	64	6WF	GG	285,21	282,41	296	54	69	135	242	28	70	14,40	248,00
72-14M-40	72	6A	GG	320,86	318,06	—	54	69	135	278	28	70	16,90	257,00
80-14M-40	80	6A	GG	356,51	353,71	—	54	69	135	314	28	70	18,50	264,00
90-14M-40	90	6A	GG	401,07	398,28	—	54	69	135	358	28	70	20,00	297,00
112-14M-40*	112	6A	GG	499,11	496,32	—	54	69	135	456	28	70	26,70	364,00
144-14M-40*	144	6A	GG	641,71	638,92	—	54	69	135	600	28	70	35,00	544,00
168-14M-40*	168	6A	GG	748,66	745,87	—	54	69	135	706	28	70	44,20	716,00
192-14M-40*	192	6A	GG	855,62	852,82	—	54	69	135	813	28	70	52,20	917,00
216-14M-40*	216	6A	GG	962,57	959,77	—	54	69	150	920	28	80	60,00	1.059,00

Type 14M – Teilung Pitch 14 mm für Riemenbreite for belt width 55 mm

28-14M-55	28	6F	GG	124,78	122,12	127	70	85	100	—	24	60	5,60	102,00
29-14M-55	29	6F	GG	129,23	126,57	138	70	85	100	—	24	60	6,10	107,00
30-14M-55	30	6F	GG	133,69	130,99	138	70	85	100	—	24	60	6,60	111,00
32-14M-55	32	6F	GG	142,60	139,88	154	70	85	100	—	24	70	7,60	119,00
34-14M-55	34	6F	GG	151,52	148,79	160	70	85	100	—	24	70	8,60	127,00
36-14M-55	36	6F	GG	160,43	157,68	168	70	85	100	—	24	70	9,60	139,00
38-14M-55	38	6F	GG	169,34	166,60	183	70	85	120	—	24	70	10,80	149,00
40-14M-55	40	6F	GG	178,25	175,49	188	70	85	120	—	24	70	11,20	161,00
44-14M-55	44	6F	GG	196,08	193,28	211	70	85	120	—	24	70	12,50	175,00
48-14M-55	48	10WF	GG	213,90	211,11	226	70	70	135	172	24	70	13,70	211,00
56-14M-55	56	10WF	GG	249,55	246,76	256	70	70	135	207	28	70	14,50	239,00
64-14M-55	64	10WF	GG	285,21	282,41	296	70	70	135	242	28	70	15,60	282,00
72-14M-55	72	10A	GG	320,86	318,06	—	70	70	135	278	28	70	18,50	289,00
80-14M-55	80	10A	GG	356,51	353,71	—	70	70	135	314	28	70	20,00	315,00
90-14M-55	90	10A	GG	401,07	398,28	—	70	70	135	358	28	70	22,60	357,00
112-14M-55*	112	10A	GG	499,11	496,32	—	70	70	135	456	28	70	29,50	440,00
144-14M-55*	144	10A	GG	641,71	638,92	—	70	70	135	600	28	70	39,00	661,00
168-14M-55*	168	10A	GG	748,66	745,87	—	70	70	135	706	28	70	48,50	859,00
192-14M-55*	192	10A	GG	855,62	852,82	—	70	70	135	813	28	70	57,80	1.025,00
216-14M-55*	216	10A	GG	962,57	959,77	—	70	70	150	920	28	80	67,00	1.250,00

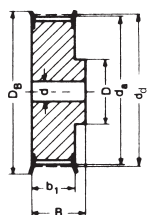

Ausf. Type 6F

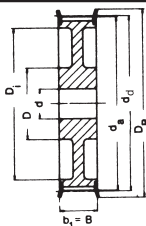

Ausf. Type 10WF

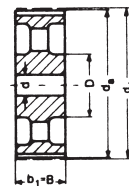

Ausf. Type 10A

Type 14M – Teilung Pitch 14 mm für Riemenbreite for belt width 85 mm

Bezeichnung Part No.	Anzahl der Zähne No. of teeth	Aus- führung Type	Material	d _d (mm)	d _a (mm)	D _B (mm)	b ₁ (mm)	B (mm)	D (mm)	D _i (mm)	Vor- bohrung Pilot bore d (mm)	Fertig- bohrung Finished bore d _{max} (mm)	Gewicht Weight (≈ kg)	€ Stück each
28-14M-85	28	6F	GG	124,78	122,12	127	102	117	100	—	24	60	7,70	125,00
29-14M-85	29	6F	GG	129,23	126,57	138	102	117	100	—	24	60	8,40	132,00
30-14M-85	30	6F	GG	133,69	130,99	138	102	117	100	—	24	60	9,10	136,00
32-14M-85	32	6F	GG	142,60	139,88	154	102	117	100	—	24	60	10,50	151,00
34-14M-85	34	6F	GG	151,52	148,79	160	102	117	100	—	24	70	11,90	169,00
36-14M-85	36	6F	GG	160,43	157,68	168	102	117	100	—	32	70	13,20	185,00
38-14M-85	38	6F	GG	169,34	166,60	183	102	117	120	—	32	70	15,15	200,00
40-14M-85	40	6F	GG	178,25	175,49	188	102	117	135	—	32	70	17,10	215,00
44-14M-85	44	6F	GG	196,08	193,28	211	102	117	135	—	32	70	23,30	248,00
48-14M-85	48	6F	GG	213,90	211,11	226	102	117	150	—	32	80	25,00	281,00
56-14M-85	56	10WF	GG	249,55	246,76	256	102	102	150	207	32	80	25,00	327,00
64-14M-85	64	10WF	GG	285,21	282,41	296	102	102	150	242	32	80	28,20	381,00
72-14M-85	72	10A	GG	320,86	318,06	—	102	102	150	278	32	80	28,80	391,00
80-14M-85	80	10A	GG	356,51	353,71	—	102	102	150	314	32	80	30,10	430,00
90-14M-85	90	10A	GG	401,07	398,28	—	102	102	150	358	32	80	33,00	479,00
112-14M-85*	112	10A	GG	499,11	496,32	—	102	102	150	456	32	80	41,80	589,00
144-14M-85*	144	10A	GG	641,71	638,92	—	102	102	150	600	32	80	52,40	843,00
168-14M-85*	168	10A	GG	748,66	745,87	—	102	102	150	706	32	80	60,30	1.125,00
192-14M-85*	192	10A	GG	855,62	852,82	—	102	102	165	813	32	90	70,20	1.339,00
216-14M-85*	216	10A	GG	962,57	959,77	—	102	102	165	920	32	90	81,00	1.647,00

Type 14M – Teilung Pitch 14 mm für Riemenbreite for belt width 115 mm

28-14M-115	28	6F	GG	124,78	122,12	127	133	148	100	—	32	60	9,20	157,00
29-14M-115	29	6F	GG	129,23	126,57	138	133	148	100	—	32	60	10,20	168,00
30-14M-115	30	6F	GG	133,69	130,99	138	133	148	100	—	32	60	11,20	175,00
32-14M-115	32	6F	GG	142,60	139,88	154	133	148	100	—	32	60	13,20	190,00
34-14M-115	34	6F	GG	151,52	148,79	160	133	148	100	—	32	70	14,80	215,00
36-14M-115	36	6F	GG	160,43	157,68	168	133	148	120	—	32	70	16,60	240,00
38-14M-115	38	6F	GG	169,34	166,60	183	133	148	120	—	32	70	19,20	257,00
40-14M-115	40	6F	GG	178,25	175,49	188	133	148	135	—	32	70	22,10	271,00
44-14M-115	44	6F	GG	196,08	193,28	211	133	148	140	—	32	80	28,00	315,00
48-14M-115	48	6F	GG	213,90	211,11	226	133	148	150	—	32	80	35,00	350,00
56-14M-115	56	6F	GG	249,55	246,76	256	133	148	150	—	32	80	44,20	424,00
64-14M-115	64	10WF	GG	285,21	282,41	296	133	133	150	242	32	80	36,80	483,00
72-14M-115	72	10A	GG	320,86	318,06	—	133	133	150	278	32	80	36,10	529,00
80-14M-115	80	10A	GG	356,51	353,71	—	133	133	150	314	32	80	38,60	589,00
90-14M-115	90	10A	GG	401,07	398,28	—	133	133	150	358	32	80	41,00	668,00
112-14M-115*	112	10A	GG	499,11	496,32	—	133	133	150	456	32	80	54,40	807,00
144-14M-115*	144	10A	GG	641,71	638,92	—	133	133	165	600	32	90	67,80	1.207,00
168-14M-115*	168	10A	GG	748,66	745,87	—	133	133	165	706	32	90	75,80	1.389,00
192-14M-115*	192	10A	GG	855,62	852,82	—	133	133	165	813	32	90	88,30	1.637,00
216-14M-115*	216	10A	GG	962,57	959,77	—	133	133	165	920	32	90	98,00	1.928,00

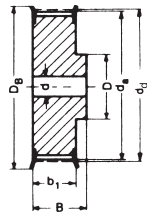

Ausf. Type 6F

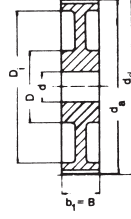

Ausf. Type 10W

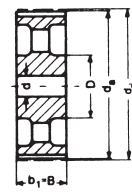

Ausf. Type 10A

Type 14M – Teilung Pitch 14 mm für Riemenbreite for belt width 170 mm

Bezeichnung Part No.	Anzahl der Zähne No. of teeth	Aus- führung Type	Material	d_d (mm)	d_a (mm)	D_B (mm)	b_1 (mm)	B (mm)	D (mm)	D_i (mm)	Vor- bohrung Pilot bore d (mm)	Fertig- bohrung Finished bore d_{max} (mm)	Gewicht Weight (≈ kg)	€ Stück each
28-14M-170*	28	6F	GG	124,78	122,12	127	187	202	100	—	32	60	13,80	202,00
29-14M-170*	29	6F	GG	129,23	126,57	138	187	202	100	—	32	60	14,20	227,00
30-14M-170*	30	6F	GG	133,69	130,99	138	187	202	100	—	32	60	15,60	231,00
32-14M-170*	32	6F	GG	142,60	139,88	154	187	202	100	—	32	60	18,10	261,00
34-14M-170*	34	6F	GG	151,52	148,79	160	187	202	100	—	32	60	20,40	308,00
36-14M-170*	36	6F	GG	160,43	157,68	168	187	202	120	—	32	70	23,50	340,00
38-14M-170*	38	6F	GG	169,34	166,60	183	187	202	135	—	32	70	26,50	357,00
40-14M-170*	40	6F	GG	178,25	175,49	188	187	202	140	—	32	85	30,10	381,00
44-14M-170*	44	6F	GG	196,08	193,28	211	187	202	160	—	32	85	37,80	416,00
48-14M-170*	48	6F	GG	213,90	211,11	226	187	202	160	—	32	85	44,50	500,00
56-14M-170*	56	6F	GG	249,55	246,76	256	187	202	160	—	32	85	61,00	622,00
64-14M-170*	64	6F	GG	285,21	282,41	296	187	202	180	—	32	100	81,00	683,00
72-14M-170*	72	10W	GG	320,86	318,06	—	187	187	180	278	32	100	61,40	727,00
80-14M-170*	80	10W	GG	356,51	353,71	—	187	187	180	314	32	100	65,00	959,00
90-14M-170*	90	10A	GG	401,07	398,28	—	187	187	180	358	38	100	68,00	688,00
112-14M-170*	112	10A	GG	499,11	496,32	—	187	187	200	456	38	110	87,50	1.223,00
144-14M-170*	144	10A	GG	641,71	638,92	—	187	187	220	600	38	120	114,80	1.537,00
168-14M-170*	168	10A	GG	748,66	745,87	—	187	187	220	706	38	120	125,00	1.831,00
192-14M-170*	192	10A	GG	855,62	852,82	—	187	187	220	813	38	120	136,40	2.015,00
216-14M-170*	216	10A	GG	962,57	959,77	—	187	187	220	920	38	120	147,00	2.549,00

HTD®-Zahnscheiben Type 20M auf Anfrage
HTD® Pulleys type 20M on request

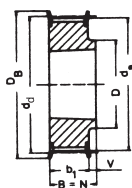

Ausf. Type 8F

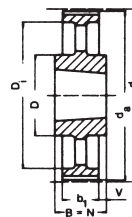

Ausf. Type 7a

Type 5M – Teilung Pitch 5 mm für Riemenbreite for belt width 15 mm

Bezeichnung Part No.	Anzahl der Zähne No. of teeth	Aus- führung Type	Mate- rial	d _d (mm)	d _a (mm)	D _B (mm)	b ₁ (mm)	B (mm)	N (mm)	V (mm)	Z (mm)	D (mm)	D ₁ (mm)	Taper- Buchse Taper bush	Gewicht ohne Buchse Weight without bush (= kg)	€ Stück ohne Buchse each without bush
TB 34-5M-15	34	8F	St	54,11	52,97	57,0	20,5	22	22	1,5	—	43	—	1008	0,190	30,80
TB 36-5M-15	36	8F	St	57,30	56,16	60,0	20,5	22	22	1,5	—	44	—	1108	0,200	31,80
TB 38-5M-15	38	8F	St	69,48	59,34	66,0	20,5	22	22	1,5	—	48	—	1108	0,250	34,00
TB 40-5M-15	40	8F	St	63,66	62,52	71,0	20,5	22	22	1,5	—	52	—	1108	0,310	36,60
TB 44-5M-15	44	8F	St	70,03	68,89	75,0	20,5	22	22	1,5	—	54	—	1108	0,400	39,80
TB 48-5M-15	48	8F	St	76,39	75,25	83,0	20,5	25	25	4,5	—	64	—	1210	0,450	45,30
TB 56-5M-15	56	8F	GG	89,13	87,99	93,0	20,5	25	25	4,5	—	70	—	1210	0,670	49,40
TB 64-5M-15	64	8F	GG	101,86	100,72	106,0	20,5	25	25	4,5	—	78	—	1210	0,960	57,10
TB 72-5M-15	72	8F	GG	114,59	113,45	119,0	20,5	25	25	4,5	—	90	—	1610	1,190	60,40
TB 80-5M-15	80	8F	GG	127,32	126,18	135,0	20,5	25	25	4,5	—	92	—	1610	1,570	65,20
TB 90-5M-15	90	7A	GG	143,24	142,10	—	20,5	25	25	2,3	—	92	—	1610	1,147	67,40
TB 112-5M-15	112	7A	GG	178,25	177,11	—	20,5	25	25	2,3	—	92	—	1610	1,940	78,00
TB 136-5M-15	136	7A	GG	216,45	215,31	—	20,5	32	32	5,8	—	106	—	2012	3,060	94,10
TB 150-5M-15	150	7A	GG	238,73	237,59	—	20,5	32	32	5,8	—	106	—	2012	3,900	116,00

Taper-Buchse Taper bush	1008	1108	1210	1610	2012
Bohrung d ₂ (mm) von ... bis ... Bore d ₂ (mm) from ... to ...	10-25	10-28	11-32	14-42	14-50
€/Stück each	6,10	7,00	9,20	11,00	13,50

GG = Grauguss Cast iron
St = Stahl Steel

Fertigungstechnische Änderungen vorbehalten.
We reserve the right to make technical changes.

Bohrungsdurchmesser d₂ siehe Seite 3.
Bore diameters d₂ see page 3.

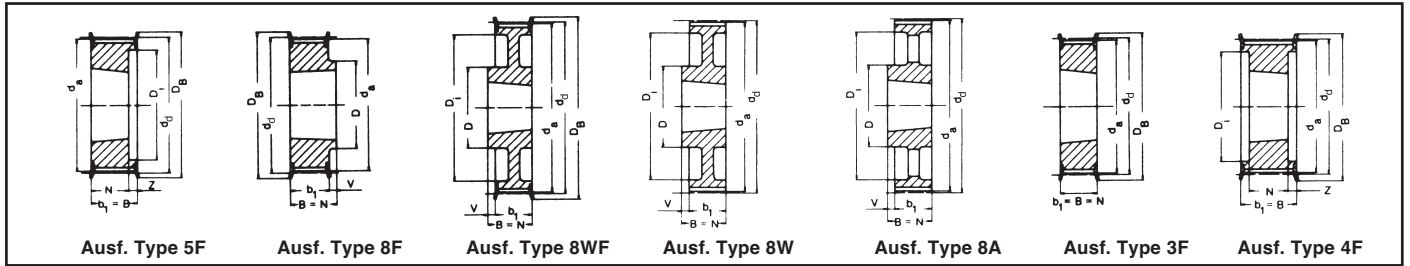

Type 8M – Teilung Pitch 8 mm für Riemenbreite for belt width 20 mm

Bezeichnung Part No.	Anzahl der Zähne No. of teeth	Aus- führung Type	Material	d_d (mm)	d_a (mm)	D_B (mm)	b_1 (mm)	B (mm)	N (mm)	V (mm)	Z (mm)	D (mm)	D_1 (mm)	Taper- Buchse Taper bush	Gewicht ohne Buchse Weight without bush (= kg)	€ Stück ohne Buchse each without bush
TB 22-8M-20	22	5F	GG	56,02	54,65	60,0	28	28	22	—	6	—	41	1008	0,24	31,10
TB 24-8M-20	24	5F	GG	61,12	59,75	66,0	28	28	22	—	6	—	42	1108	0,30	31,80
TB 26-8M-20	26	5F	GG	66,21	64,84	71,0	28	28	22	—	6	—	46	1108	0,36	33,10
TB 28-8M-20	28	5F	GG	71,30	70,08	75,0	28	28	22	—	6	—	50	1108	0,44	33,40
TB 30-8M-20	30	5F	GG	76,39	75,13	83,0	28	28	22	—	6	—	58	1108	0,53	34,70
TB 32-8M-20	32	5F	GG	81,49	80,16	87,0	28	28	25	—	3	—	62	1610	0,42	35,60
TB 34-8M-20	34	5F	GG	86,58	85,22	91,0	28	28	25	—	3	—	65	1610	0,55	37,90
TB 36-8M-20	36	5F	GG	91,67	90,30	98,5	28	28	25	—	3	—	68	1610	0,68	39,50
TB 38-8M-20	38	5F	GG	96,77	95,39	103,0	28	28	25	—	3	—	72	1610	0,80	41,40
TB 40-8M-20	40	5F	GG	101,86	100,49	106,0	28	28	25	—	3	—	76	1610	1,00	44,90
TB 44-8M-20	44	8F	GG	112,05	110,67	119,0	28	32	32	4	—	93	—	2012	1,20	50,40
TB 48-8M-20	48	8F	GG	122,23	120,86	127,0	28	32	32	4	—	96	—	2012	1,60	57,10
TB 56-8M-20	56	8F	GG	142,60	141,23	148,0	28	32	32	4	—	110	—	2012	2,40	67,70
TB 64-8M-20	64	8WF	GG	162,97	161,60	168,0	28	32	32	4	—	110	137	2012	2,70	84,10
TB 72-8M-20	72	8WF	GG	183,35	181,97	192,0	28	32	32	4	—	110	158	2012	3,30	99,20
TB 80-8M-20	80	8W	GG	203,72	202,35	—	28	32	32	4	—	110	180	2012	3,50	112,00
TB 90-8M-20	90	8A	GG	229,18	227,81	—	28	32	32	4	—	110	204	2012	3,65	125,00

Type 8M – Teilung Pitch 8 mm für Riemenbreite for belt width 30 mm

TB 22-8M-30	22	5F	GG	56,02	54,65	60,0	38	38	22	—	16	—	41	1008	0,29	34,70
TB 24-8M-30	24	5F	GG	61,12	59,75	66,0	38	38	22	—	16	—	42	1108	0,38	35,30
TB 26-8M-30	26	5F	GG	66,21	64,84	71,0	38	38	22	—	16	—	46	1108	0,45	36,90
TB 28-8M-30	28	5F	GG	71,30	70,08	75,0	38	38	25	—	13	—	50	1210	0,50	38,20
TB 30-8M-30	30	3F	GG	76,39	75,13	83,0	38	38	38	—	—	—	—	1615	0,45	39,20
TB 32-8M-30	32	3F	GG	81,49	80,16	87,0	38	38	38	—	—	—	—	1615	0,59	40,10
TB 34-8M-30	34	3F	GG	86,58	85,22	91,0	38	38	38	—	—	—	—	1615	0,77	42,40
TB 36-8M-30	36	3F	GG	91,67	90,30	98,5	38	38	38	—	—	—	—	1615	0,96	44,00
TB 38-8M-30	38	3F	GG	96,77	95,39	103,0	38	38	38	—	—	—	—	1615	1,15	47,80
TB 40-8M-30	40	3F	GG	101,86	100,49	106,0	38	38	38	—	—	—	—	1615	1,34	50,40
TB 44-8M-30	44	4F	GG	112,05	110,67	119,0	38	38	32	—	3	—	91	2012	1,33	57,80
TB 48-8M-30	48	4F	GG	122,23	120,86	127,0	38	38	32	—	3	—	95	2012	1,78	64,50
TB 56-8M-30	56	4F	GG	142,60	141,23	148,0	38	38	32	—	3	—	117	2012	3,76	79,60
TB 64-8M-30	64	8F	GG	162,97	161,60	168,0	38	45	45	7	—	125	—	2517	4,20	95,00
TB 72-8M-30	72	8WF	GG	183,35	181,97	192,0	38	45	45	7	—	125	158	2517	4,30	116,00
TB 80-8M-30	80	8W	GG	203,72	202,35	—	38	45	45	7	—	125	180	2517	4,60	128,00
TB 90-8M-30	90	8A	GG	229,18	227,81	—	38	45	45	7	—	125	204	2517	5,00	148,00
TB 112-8M-30	112	8A	GG	285,21	283,83	—	38	45	45	7	—	125	260	2517	6,20	179,00
TB 144-8M-30	144	8A	GG	366,69	365,32	—	38	45	45	7	—	125	341	2517	9,00	236,00

Taper-Buchse Taper bush	1008	1108	1210	1610	1615	2012	2517
Bohrung d_2 (mm) von ... bis ... Bore d_2 (mm) from ... to ...	10-25	10-28	11-32	14-42	14-42	14-50	16-60
€/Stück each	6,10	7,00	9,20	11,00	11,50	13,50	16,90

GG = Grauguss Cast iron
 Fertigungstechnische Änderungen vorbehalten.
 We reserve the right to make technical changes.
 Bohrungsdurchmesser d_2 siehe Seite 3.
 Bore diameters d_2 see page 3.

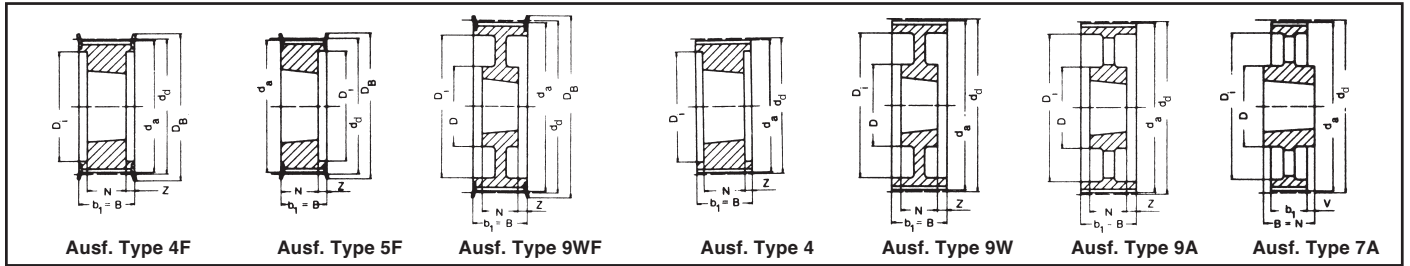

Type 8M – Teilung Pitch 8 mm für Riemenbreite for belt width 50 mm

Bezeichnung Part No.	Anzahl der Zähne No. of teeth	Aus- führung Type	Material	d _d (mm)	d _a (mm)	D _B (mm)	b ₁ (mm)	B (mm)	N (mm)	V (mm)	Z (mm)	D (mm)	D ₁ (mm)	Taper- Buchse Taper bush	Gewicht ohne Buchse Weight without bush (= kg)	€ Stück ohne Buchse each without bush
TB 28-8M-50	28	5F	GG	71,30	70,08	75,0	60	60	25	—	35,0	—	50	1210	0,60	44,60
TB 30-8M-50	30	5F	GG	76,39	75,13	83,0	60	60	38	—	22,0	—	58	1615	0,65	47,80
TB 32-8M-50	32	5F	GG	81,49	80,16	87,0	60	60	38	—	22,0	—	62	1615	0,82	51,00
TB 34-8M-50	34	5F	GG	86,58	85,22	91,0	60	60	38	—	22,0	—	65	1615	1,06	54,60
TB 36-8M-50	36	5F	GG	91,67	90,30	98,5	60	60	38	—	22,0	—	68	1615	1,30	58,40
TB 38-8M-50	38	5F	GG	96,77	95,39	103,0	60	60	38	—	22,0	—	72	1615	1,60	62,90
TB 40-8M-50	40	4F	GG	101,86	100,49	106,0	60	60	32	—	14,0	—	82	2012	1,71	66,10
TB 44-8M-50	44	4F	GG	112,05	110,67	119,0	60	60	32	—	14,0	—	91	2012	1,78	76,10
TB 48-8M-50	48	4F	GG	122,23	120,86	127,0	60	60	32	—	14,0	—	95	2012	2,30	84,10
TB 56-8M-50	56	4F	GG	142,60	141,23	148,0	60	60	45	—	7,5	—	116	2517	3,40	102,00
TB 64-8M-50	64	4F	GG	162,97	161,60	168,0	60	60	45	—	7,5	—	137	2517	5,00	121,00
TB 72-8M-50	72	9WF	GG	183,35	181,97	192,0	60	60	45	—	7,5	125	158	2517	6,70	142,00
TB 80-8M-50	80	4	GG	203,72	202,35	—	60	60	51	—	4,5	—	180	3020	8,80	169,00
TB 90-8M-50	90	9W	GG	229,18	227,81	—	60	60	51	—	4,5	170	204	3020	10,00	192,00
TB 112-8M-50	112	9W	GG	285,21	283,83	—	60	60	51	—	4,5	170	260	3020	12,00	245,00
TB 144-8M-50	144	9A	GG	366,69	365,32	—	60	60	51	—	4,5	170	341	3020	15,20	331,00
TB 168-8M-50	168	7A	GG	427,81	426,44	—	60	65	65	—	2,5	170	402	3525	16,40	437,00
TB 192-8M-50	192	7A	GG	488,92	487,55	—	60	65	65	—	2,5	170	460	3525	21,80	529,00

Type 8M – Teilung Pitch 8 mm für Riemenbreite for belt width 85 mm

TB 34-8M-85	34	4F	GG	86,58	85,22	91,0	95	95	38	—	28,5	—	65	1615	1,43	72,90
TB 36-8M-85	36	4F	GG	91,67	90,30	98,5	95	95	38	—	28,5	—	68	1615	1,87	79,60
TB 38-8M-85	38	4F	GG	96,77	95,39	103,0	95	95	38	—	28,5	—	72	1615	2,20	84,10
TB 40-8M-85	40	4F	GG	101,86	100,49	106,0	95	95	32	—	31,5	—	82	2012	1,78	89,20
TB 44-8M-85	44	4F	GG	112,05	110,67	119,0	95	95	32	—	31,5	—	91	2012	2,30	99,20
TB 48-8M-85	48	4F	GG	122,23	120,86	127,0	95	95	45	—	25,0	—	100	2517	2,66	112,00
TB 56-8M-85	56	4F	GG	142,60	141,23	148,0	95	95	45	—	25,0	—	117	2517	4,45	137,00
TB 64-8M-85	64	4F	GG	162,97	161,60	168,0	95	95	45	—	25,0	—	137	2517	6,20	166,00
TB 72-8M-85	72	4F	GG	183,35	181,97	192,0	95	95	51	—	22,0	—	158	3020	8,00	199,00
TB 80-8M-85	80	4	GG	203,72	202,35	—	95	95	51	—	22,0	—	180	3020	10,00	215,00
TB 90-8M-85	90	9W	GG	229,18	227,81	—	95	95	51	—	22,0	170	204	3020	10,80	251,00
TB 112-8M-85	112	9W	GG	285,21	283,83	—	95	95	51	—	22,0	170	260	3020	15,00	324,00
TB 144-8M-85	144	9A	GG	366,69	365,32	—	95	95	76	—	15,0	170	341	3525	20,00	461,00
TB 168-8M-85	168	9A	GG	427,81	426,44	—	95	95	76	—	15,0	170	402	3525	23,00	584,00
TB 192-8M-85	192	9A	GG	488,92	487,55	—	95	95	76	—	15,0	170	460	3525	28,50	664,00

Taper-Buchse Taper bush	1210	1615	2012	2517	3020	3525
Bohrung d ₂ (mm) von ... bis ... Bore d ₂ (mm) from ... to ...	11-32	14-42	14-50	16-60	25-75	35-90
€/Stück each	9,20	11,50	13,50	16,90	22,00	58,50

GG = Grauguss Cast iron
 Fertigungstechnische Änderungen vorbehalten.
 We reserve the right to make technical changes.
 Bohrungsdurchmesser d₂ siehe Seite 3.
 Bore diameters d₂ see page 3.

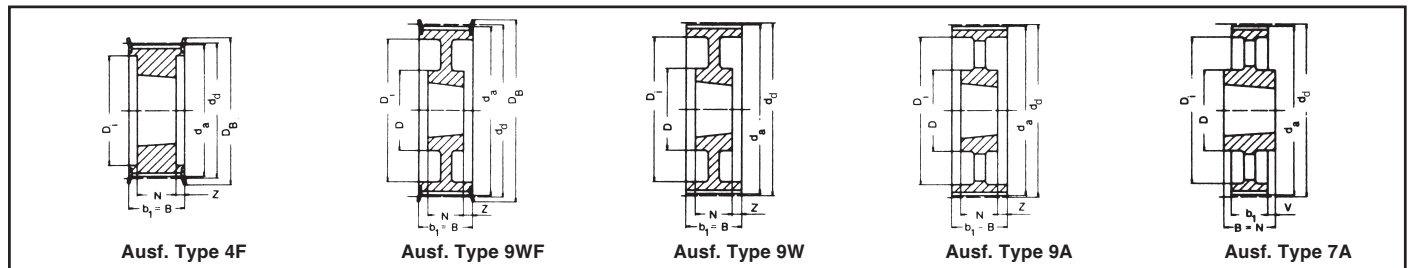

Type 14M – Teilung Pitch 14 mm für Riemenbreite for belt width 40 mm

Bezeichnung Part No.	Anzahl der Zähne No. of teeth	Aus- führung Type	Material	d _d (mm)	d _a (mm)	D _B (mm)	b ₁ (mm)	B (mm)	N (mm)	V (mm)	Z (mm)	D (mm)	D ₁ (mm)	Taper- Buchse Taper bush	Gewicht ohne Buchse Weight without bush (= kg)	€ Stück ohne Buchse each without bush
TB 28-14M-40	28	4F	GG	124,78	122,12	127	54	54	32	—	11,0	—	98	2012	2,00	102,00
TB 29-14M-40	29	4F	GG	129,23	126,57	138	54	54	32	—	11,0	—	100	2012	2,38	105,00
TB 30-14M-40	30	4F	GG	133,69	130,99	138	54	54	32	—	11,0	—	100	2012	2,65	112,00
TB 32-14M-40	32	4F	GG	142,60	139,88	154	54	54	32	—	11,0	—	104	2012	3,40	119,00
TB 34-14M-40	34	4F	GG	151,52	148,79	160	54	54	45	—	4,5	—	110	2517	3,87	125,00
TB 36-14M-40	36	4F	GG	160,43	157,68	168	54	54	45	—	4,5	—	120	2517	4,80	139,00
TB 38-14M-40	38	4F	GG	169,34	166,60	183	54	54	45	—	4,5	—	130	2517	5,40	146,00
TB 40-14M-40	40	4F	GG	178,25	175,49	188	54	54	45	—	4,5	—	138	2517	6,00	157,00
TB 44-14M-40	44	4F	GG	196,08	193,28	211	54	54	51	—	1,5	—	155	3020	7,80	170,00
TB 48-14M-40	48	4F	GG	213,90	211,11	226	54	54	51	—	1,5	—	170	3020	9,40	211,00
TB 56-14M-40	56	9WF	GG	249,55	246,76	256	54	54	51	—	1,5	170	208	3020	10,80	236,00
TB 64-14M-40	64	9WF	GG	285,21	282,41	296	54	54	51	—	1,5	170	242	3020	13,40	248,00
TB 72-14M-40	72	9W	GG	320,86	318,06	—	54	54	51	—	1,5	170	280	3020	15,20	297,00
TB 80-14M-40	80	9A	GG	356,51	353,71	—	54	54	51	—	1,5	170	315	3020	16,00	331,00
TB 90-14M-40	90	9A	GG	401,07	398,28	—	54	54	51	—	1,5	170	360	3020	17,80	397,00
TB 112-14M-40	112	9A	GG	499,11	496,32	—	54	54	51	—	1,5	170	457	3020	25,60	479,00
TB 144-14M-40	144	9A	GG	641,71	638,92	—	54	54	51	—	1,5	170	600	3020	32,00	728,00
TB 168-14M-40	168	9A	GG	748,66	745,87	—	54	54	51	—	1,5	170	706	3020	44,00	777,00
TB 192-14M-40	192	9A	GG	855,62	852,82	—	54	54	51	—	1,5	170	813	3020	49,00	952,00
TB 216-14M-40	216	9A	GG	962,57	959,77	—	54	54	51	—	1,5	170	920	3020	55,00	1.213,00

Type 14M – Teilung Pitch 14 mm für Riemenbreite for belt width 55 mm

TB 28-14M-55	28	4F	GG	124,78	122,12	127	70	70	32	—	19,0	—	98	2012	2,20	116,00
TB 29-14M-55	29	4F	GG	129,23	126,57	138	70	70	32	—	19,0	—	100	2012	2,74	119,00
TB 30-14M-55	30	4F	GG	133,69	130,99	138	70	70	45	—	12,5	—	100	2517	2,70	125,00
TB 32-14M-55	32	4F	GG	142,60	139,88	154	70	70	45	—	12,5	—	108	2517	3,66	142,00
TB 34-14M-55	34	4F	GG	151,52	148,79	160	70	70	45	—	12,5	—	110	2517	4,55	155,00
TB 36-14M-55	36	4F	GG	160,43	157,68	168	70	70	45	—	12,5	—	120	2517	5,20	166,00
TB 38-14M-55	38	4F	GG	169,34	166,60	183	70	70	45	—	12,5	—	130	2517	6,20	175,00
TB 40-14M-55	40	4F	GG	178,25	175,49	188	70	70	45	—	12,5	—	138	2517	7,00	185,00
TB 44-14M-55	44	4F	GG	196,08	193,28	211	70	70	51	—	9,5	—	155	3020	8,60	209,00
TB 48-14M-55	48	4F	GG	213,90	211,11	226	70	70	51	—	9,5	—	170	3020	10,40	239,00
TB 56-14M-55	56	9WF	GG	249,55	246,76	256	70	70	51	—	9,5	170	208	3020	12,00	285,00
TB 64-14M-55	64	9WF	GG	285,21	282,41	296	70	70	51	—	9,5	170	242	3020	14,50	311,00
TB 72-14M-55	72	9W	GG	320,86	318,06	—	70	70	51	—	9,5	170	280	3020	16,20	337,00
TB 80-14M-55	80	9A	GG	356,51	353,71	—	70	70	51	—	9,5	170	315	3020	17,50	364,00
TB 90-14M-55	90	9A	GG	401,07	398,28	—	70	70	51	—	9,5	170	360	3020	20,10	414,00
TB 112-14M-55	112	9A	GG	499,11	496,32	—	70	70	51	—	9,5	170	457	3020	28,40	529,00
TB 144-14M-55	144	9A	GG	641,71	638,92	—	70	70	51	—	9,5	170	600	3020	36,20	767,00
TB 168-14M-55	168	9A	GG	748,66	745,87	—	70	70	51	—	9,5	170	706	3020	49,00	992,00
TB 192-14M-55	192	9A	GG	855,62	852,82	—	70	70	51	—	9,5	170	813	3020	53,00	1.141,00
TB 216-14M-55	216	7A	GG	962,57	959,77	—	70	89	89	9,5	—	190	920	3535	65,80	1.442,00

Taper-Buchse Taper bush	2012	2517	3020	3535
Bohrung d ₂ (mm) von ... bis ... Bore d ₂ (mm) from ... to ...	14-50	16-60	25-75	35-90
€/Stück each	13,50	16,90	22,00	55,50

GG = Grauguss Cast iron
 Fertigungstechnische Änderungen vorbehalten.
 We reserve the right to make technical changes.
 Bohrungsdurchmesser d₂ siehe Seite 3.
 Bore diameters d₂ see page 3.

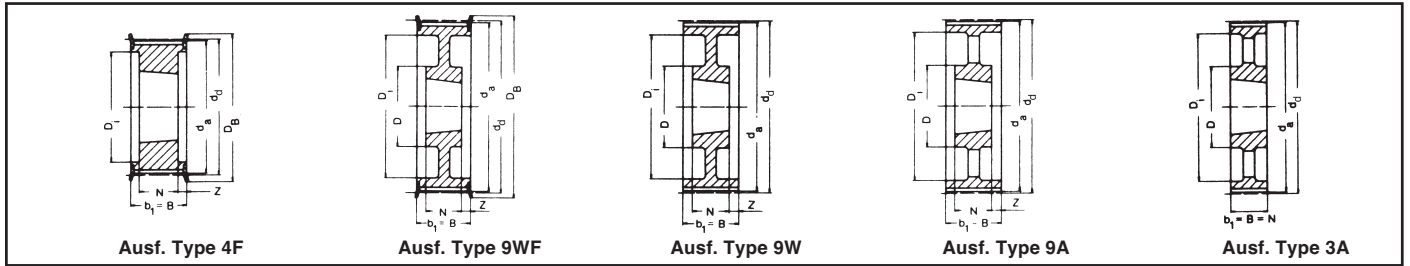

Type 14M – Teilung Pitch 14 mm für Riemenbreite for belt width 85 mm

Bezeichnung Part No.	Anzahl der Zähne No. of teeth	Aus- führung Type	Material	d _d (mm)	d _a (mm)	D _B (mm)	b ₁ (mm)	B (mm)	N (mm)	V (mm)	Z (mm)	D (mm)	D ₁ (mm)	Taper- Buchse Taper bush	Gewicht ohne Buchse Weight without bush (= kg)	€ Stück ohne Buchse each without bush
TB 28-14M-85	28	4F	GG	124,78	122,12	127	102	102	45	—	28,5	—	98	2517	2,70	146,00
TB 29-14M-85	29	4F	GG	129,23	126,57	138	102	102	45	—	28,5	—	100	2517	3,40	150,00
TB 30-14M-85	30	4F	GG	133,69	130,99	138	102	102	45	—	28,5	—	100	2517	3,75	158,00
TB 32-14M-85	32	4F	GG	142,60	139,88	154	102	102	45	—	28,5	—	108	2517	4,80	175,00
TB 34-14M-85	34	4F	GG	151,52	148,79	160	102	102	45	—	28,5	—	110	2517	6,00	199,00
TB 36-14M-85	36	4F	GG	160,43	157,68	168	102	102	51	—	25,5	—	120	3020	5,80	209,00
TB 38-14M-85	38	4F	GG	169,34	166,60	183	102	102	51	—	25,5	—	130	3020	6,80	215,00
TB 40-14M-85	40	4F	GG	178,25	175,49	188	102	102	51	—	25,5	—	138	3020	8,00	231,00
TB 44-14M-85	44	4F	GG	196,08	193,28	211	102	102	76	—	13,0	—	155	3030	11,80	275,00
TB 48-14M-85	48	4F	GG	213,90	211,11	226	102	102	76	—	13,0	—	170	3030	15,10	297,00
TB 56-14M-85	56	4F	GG	249,55	246,76	256	102	102	65	—	18,5	190	210	3525	19,00	364,00
TB 64-14M-85	64	9WF	GG	285,21	282,41	296	102	102	65	—	18,5	190	242	3525	23,00	397,00
TB 72-14M-85	72	9W	GG	320,86	318,06	—	102	102	65	—	18,5	190	280	3525	25,00	430,00
TB 80-14M-85	80	9A	GG	356,51	353,71	—	102	102	65	—	18,5	190	315	3525	26,00	449,00
TB 90-14M-85	90	9A	GG	401,07	398,28	—	102	102	65	—	18,5	190	360	3525	27,80	539,00
TB 112-14M-85	112	9A	GG	499,11	496,32	—	102	102	65	—	18,5	190	457	3525	36,50	728,00
TB 144-14M-85	144	9A	GG	641,71	638,92	—	102	102	65	—	18,5	190	600	3525	48,00	926,00
TB 168-14M-85	168	9A	GG	748,66	745,87	—	102	102	65	—	18,5	190	706	3525	60,00	1.158,00
TB 192-14M-85	192	3A	GG	855,62	852,82	—	102	102	102	—	—	230	813	4040	86,00	1.405,00
TB 216-14M-85	216	3A	GG	962,57	959,77	—	102	102	102	—	—	230	920	4040	91,50	1.792,00

Type 14M – Teilung Pitch 14 mm für Riemenbreite for belt width 115 mm

TB 28-14M-115	28	4F	GG	124,78	122,12	127	133	133	45	—	44,0	—	98	2517	3,77	205,00
TB 29-14M-115	29	4F	GG	129,23	126,57	138	133	133	45	—	44,0	—	100	2517	4,00	212,00
TB 30-14M-115	30	4F	GG	133,69	130,99	138	133	133	45	—	44,0	—	100	2517	5,00	215,00
TB 32-14M-115	32	4F	GG	142,60	139,88	154	133	133	45	—	44,0	—	108	2517	6,80	231,00
TB 34-14M-115	34	4F	GG	151,52	148,79	160	133	133	45	—	44,0	—	110	2517	6,80	251,00
TB 36-14M-115	36	4F	GG	160,43	157,68	168	133	133	51	—	41,0	—	120	3020	7,00	271,00
TB 38-14M-115	38	4F	GG	169,34	166,60	183	133	133	51	—	41,0	—	130	3020	8,40	294,00
TB 40-14M-115	40	4F	GG	178,25	175,49	188	133	133	51	—	41,0	—	140	3020	9,20	304,00
TB 44-14M-115	44	4F	GG	196,08	193,28	211	133	133	76	—	28,5	—	155	3030	14,00	345,00
TB 48-14M-115	48	4F	GG	213,90	211,11	226	133	133	76	—	28,5	—	170	3030	17,10	445,00
TB 56-14M-115	56	4F	GG	249,55	246,76	256	133	133	89	—	22,0	—	210	3535	24,80	455,00
TB 64-14M-115	64	9WF	GG	285,21	282,41	296	133	133	89	—	22,0	190	242	3535	27,00	495,00
TB 72-14M-115	72	9W	GG	320,86	318,06	—	133	133	89	—	22,0	190	280	3535	29,00	534,00
TB 80-14M-115	80	9A	GG	356,51	353,71	—	133	133	89	—	22,0	190	315	3535	32,00	694,00
TB 90-14M-115	90	9A	GG	401,07	398,28	—	133	133	89	—	22,0	190	360	3535	36,50	761,00
TB 112-14M-115	112	9A	GG	499,11	496,32	—	133	133	89	—	22,0	190	457	3535	46,00	936,00
TB 144-14M-115	144	9A	GG	641,71	638,92	—	133	133	102	—	15,5	230	600	4040	68,00	1.172,00
TB 168-14M-115	168	9A	GG	748,66	745,87	—	133	133	102	—	15,5	230	706	4040	82,60	1.471,00
TB 192-14M-115	192	9A	GG	855,62	852,82	—	133	133	102	—	15,5	230	813	4040	96,00	1.719,00
TB 216-14M-115	216	9A	GG	962,57	959,77	—	133	133	102	—	15,5	230	920	4040	107,00	2.180,00

Taper-Buchse Taper bush	2517	3020	3030	3525	3535	4040
Bohrung d ₂ (mm) von ... bis ... Bore d ₂ (mm) from ... to ...	16-60	25-75	35-75	35-90	35-90	40-100
€/Stück each	16,90	22,00	28,80	58,50	55,50	78,00

GG = Grauguss Cast iron

Fertigungstechnische Änderungen vorbehalten.
 We reserve the right to make technical changes.

Bohrungsdurchmesser d₂ siehe Seite 3.
 Bore diameters d₂ see page 3.

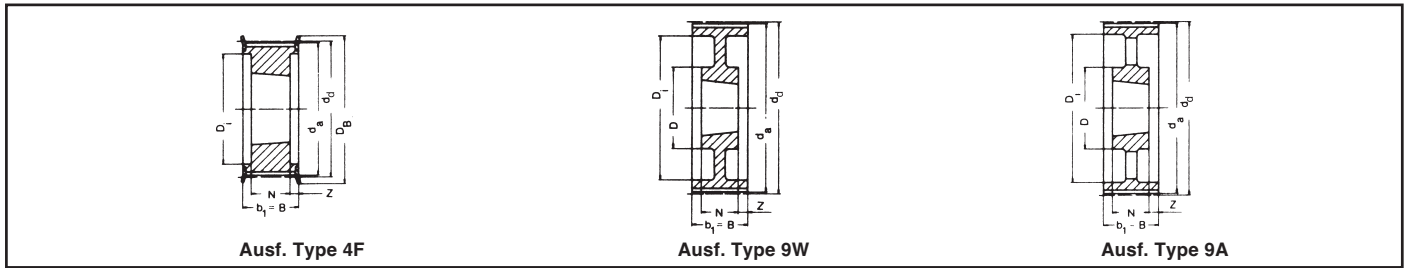

Type 14M – Teilung Pitch 14 mm für Riemenbreite for belt width 170 mm

Bezeichnung Part No.	Anzahl der Zähne No. of teeth	Aus- führung Type	Mate- rial	d _d (mm)	d _a (mm)	D _B (mm)	b ₁ (mm)	B (mm)	N (mm)	V (mm)	Z (mm)	D (mm)	D ₁ (mm)	Taper- Buchse Taper bush	Gewicht ohne Buchse Weight without bush (= kg)	€ Stück ohne Buchse each without bush
TB 38-14M-170*	38	4F	GG	169,34	166,60	183	187	187	76	—	55,5	—	130	3030	11,70	427,00
TB 40-14M-170*	40	4F	GG	178,25	175,49	188	187	187	76	—	55,5	—	140	3030	13,00	441,00
TB 44-14M-170*	44	4F	GG	196,08	193,28	211	187	187	89	—	49,0	—	155	3535	15,00	477,00
TB 48-14M-170*	48	4F	GG	213,90	211,11	226	187	187	89	—	49,0	—	175	3535	19,00	591,00
TB 56-14M-170*	56	4F	GG	249,55	246,76	256	187	187	89	—	49,0	—	210	3535	28,50	617,00
TB 64-14M-170*	64	4F	GG	285,21	282,41	296	187	187	102	—	42,5	—	240	4040	41,00	664,00
TB 72-14M-170*	72	9W	GG	320,86	318,06	—	187	187	102	—	42,5	230	280	4040	46,90	724,00
TB 80-14M-170*	80	9W	GG	356,51	353,71	—	187	187	102	—	42,5	230	315	4040	48,00	923,00
TB 90-14M-170*	90	9A	GG	401,07	398,28	—	187	187	102	—	42,5	230	360	4040	52,50	1.030,00
TB 112-14M-170*	112	9A	GG	499,11	496,32	—	187	187	127	—	30,0	265	457	5050	74,50	1.254,00
TB 144-14M-170*	144	9A	GG	641,71	638,92	—	187	187	127	—	30,0	265	600	5050	91,00	1.571,00
TB 168-14M-170*	168	9A	GG	748,66	745,87	—	187	187	127	—	30,0	265	706	5050	116,00	1.966,00
TB 192-14M-170*	192	9A	GG	855,62	852,82	—	187	187	127	—	30,0	265	813	5050	134,00	2.299,00
TB 216-14M-170*	216	9A	GG	962,57	959,77	—	187	187	127	—	30,0	265	920	5050	146,50	2.902,00

**HTD®-Zahnscheiben Type 20M auf Anfrage
 HTD® Pulleys type 20M on request**

Taper-Buchse Taper bush	3030	3535	4040	5050
Bohrung d ₂ (mm) von ... bis ... Bore d ₂ (mm) from ... to ...	35-75	35-90	40-100	70-125
€/Stück each	28,80	55,50	78,00	159,00

GG = Grauguss Cast iron
 Fertigungstechnische Änderungen vorbehalten.
 We reserve the right to make technical changes.
 * Keine Lagerware Non stock items
 Bohrungsdurchmesser d₂ siehe Seite 3.
 Bore diameters d₂ see page 3.

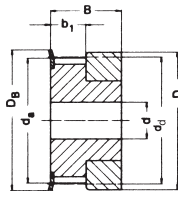

Ausf. Type 1F

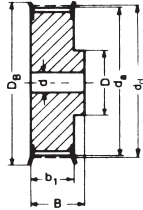

Ausf. Type 6F

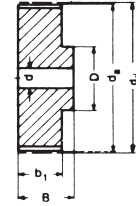

Ausf. Type 6

Type T 2,5 – Teilung Pitch 2,5 mm für Riemenbreite for belt width 4 und and 6 mm

Bezeichnung Part No.	Anzahl der Zähne No. of teeth	Aus- führung Type	Material	d_d (mm)	d_a (mm)	D_B (mm)	b_1 (mm)	B (mm)	D (mm)	D_i (mm)	Vor- bohrung Pilot bore d (mm)	Fertig- bohrung Finished bore d_{max} (mm)	Gewicht Weight (≈ kg)	€ Stück each
16 T2,5/12-2	12	1F	Al	9,55	9,00	13,0	9	16	12	—	—	3	0,003	9,00
16 T2,5/14-2	14	1F	Al	11,14	10,60	15,0	9	16	14	—	—	4	0,004	9,00
16 T2,5/15-2	15	1F	Al	11,94	11,40	15,0	9	16	15	—	—	4	0,005	9,00
16 T2,5/16-2	16	1F	Al	12,73	12,20	16,0	9	16	16	—	—	5	0,005	9,30
16 T2,5/18-2	18	6F	Al	14,32	13,80	17,5	10	16	9,5	—	4	6	0,006	9,30
16 T2,5/19-2	19	6F	Al	15,12	14,60	18,0	10	16	9,5	—	4	6	0,007	9,60
16 T2,5/20-2	20	6F	Al	15,92	15,40	19,5	10	16	10	—	4	6	0,008	9,60
16 T2,5/22-2	22	6F	Al	17,51	17,00	23,0	10	16	10	—	4	6	0,009	9,60
16 T2,5/24-2	24	6F	Al	19,10	18,55	23,0	10	16	12	—	4	6	0,012	10,00
16 T2,5/25-2	25	6F	Al	19,90	19,35	23,0	10	16	12	—	4	8	0,013	10,00
16 T2,5/26-2	26	6F	Al	20,70	20,15	25,0	10	16	13	—	4	8	0,014	10,30
16 T2,5/28-2	28	6F	Al	22,28	21,75	25,0	10	16	13	—	4	8	0,016	10,30
16 T2,5/30-2	30	6F	Al	23,87	23,35	28,0	10	16	16	—	6	10	0,018	10,60
16 T2,5/32-2	32	6F	Al	25,47	24,95	32,0	10	16	16	—	6	10	0,020	10,60
16 T2,5/36-2	36	6F	Al	28,65	28,10	36,0	10	16	20	—	6	12	0,026	10,90
16 T2,5/40-2	40	6F	Al	31,83	31,30	38,0	10	16	20	—	6	12	0,032	11,20
16 T2,5/44-2	44	6F	Al	35,02	34,50	42,0	10	16	24	—	6	14	0,040	11,60
16 T2,5/48-0	48	6	Al	38,20	37,70	—	10	16	26	—	6	15	0,048	11,90
16 T2,5/60-0	60	6	Al	47,75	47,25	—	10	16	34	—	8	18	0,073	12,80

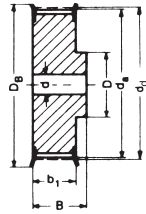

Ausf. Type 6F

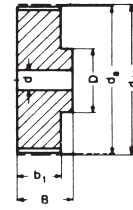

Ausf. Type 6

Type T 5 – Teilung Pitch 5 mm für Riemenbreite for belt width 10 mm

Bezeichnung Part No.	Anzahl der Zähne No. of teeth	Aus- führung Type	Material	d _d (mm)	d _a (mm)	D _B (mm)	b ₁ (mm)	B (mm)	D (mm)	D _i (mm)	Vor- bohrung Pilot bore d (mm)	Fertig- bohrung Finished bore d _{max} (mm)	Gewicht Weight (≈ kg)	€ Stück each
21 T5/10-2	10	6F	Al	15,92	15,05	19,5	15	21	8	—	—	5	0,012	10,30
21 T5/12-2	12	6F	Al	19,01	18,25	23,0	15	21	10	—	—	6	0,016	10,60
21 T5/14-2	14	6F	Al	22,29	21,45	25,0	15	21	13	—	—	8	0,019	10,90
21 T5/15-2	15	6F	Al	23,88	23,05	28,0	15	21	16	—	6	10	0,021	11,20
21 T5/16-2	16	6F	Al	25,47	24,60	32,0	15	21	18	—	6	11	0,025	11,90
21 T5/18-2	18	6F	Al	28,65	27,80	32,0	15	21	19	—	6	12	0,031	13,50
21 T5/19-2	19	6F	Al	30,25	29,40	36,0	15	21	22	—	6	12	0,036	13,80
21 T5/20-2	20	6F	Al	31,83	31,00	36,0	15	21	23	—	6	14	0,038	14,10
21 T5/22-2	22	6F	Al	35,12	34,25	38,0	15	21	24	—	6	15	0,046	14,50
21 T5/24-2	24	6F	Al	38,21	37,40	42,0	15	21	26	—	6	15	0,054	14,80
21 T5/25-2	25	6F	Al	39,80	39,00	44,0	15	21	26	—	6	15	0,058	15,10
21 T5/26-2	26	6F	Al	41,47	40,60	44,0	15	21	26	—	6	16	0,062	15,10
21 T5/27-2	27	6F	Al	42,98	42,20	48,0	15	21	30	—	8	18	0,064	15,40
21 T5/28-2	28	6F	Al	44,62	43,75	48,0	15	21	32	—	8	18	0,071	15,40
21 T5/30-2	30	6F	Al	47,76	46,95	51,0	15	21	34	—	8	18	0,075	15,70
21 T5/32-2	32	6F	Al	50,94	50,10	54,0	15	21	38	—	8	22	0,088	17,00
21 T5/36-2	36	6F	Al	57,31	56,45	63,0	15	21	38	—	8	22	0,114	18,00
21 T5/40-2	40	6F	Al	63,66	62,85	66,0	15	21	40	—	8	23	0,138	19,90
21 T5/42-2	42	6F	Al	66,87	66,00	71,0	15	21	40	—	8	24	0,180	20,20
21 T5/44-0	44	6	Al	70,07	69,20	—	15	21	45	—	8	26	0,185	20,50
21 T5/48-0	48	6	Al	76,42	75,55	—	15	21	50	—	8	28	0,200	23,10
21 T5/60-0	60	6	Al	95,52	94,65	—	15	21	65	—	8	35	0,307	26,30

Type T 5 – Teilung Pitch 5 mm für Riemenbreite for belt width 16 mm

27 T5/10-2	10	6F	Al	15,92	15,05	19,5	21	27	8	—	—	5	0,016	10,90
27 T5/12-2	12	6F	Al	19,01	18,25	23,0	21	27	10	—	—	6	0,022	11,20
27 T5/14-2	14	6F	Al	22,29	21,45	25,0	21	27	13	—	—	8	0,026	11,60
27 T5/15-2	15	6F	Al	23,88	23,05	28,0	21	27	16	—	6	10	0,029	11,90
27 T5/16-2	16	6F	Al	25,47	24,60	32,0	21	27	18	—	6	11	0,035	12,80
27 T5/18-2	18	6F	Al	28,65	27,80	32,0	21	27	19	—	6	12	0,043	14,10
27 T5/19-2	19	6F	Al	30,25	29,40	36,0	21	27	22	—	6	12	0,049	14,50
27 T5/20-2	20	6F	Al	31,83	31,00	36,0	21	27	23	—	6	14	0,053	15,10
27 T5/22-2	22	6F	Al	35,12	34,25	38,0	21	27	24	—	6	15	0,054	15,40
27 T5/24-2	24	6F	Al	38,21	37,40	42,0	21	27	26	—	6	15	0,076	15,70
27 T5/25-2	25	6F	Al	39,80	39,00	44,0	21	27	26	—	6	15	0,081	16,10
27 T5/26-2	26	6F	Al	41,47	40,60	44,0	21	27	26	—	6	16	0,085	16,40
27 T5/27-2	27	6F	Al	42,98	42,20	48,0	21	27	30	—	8	18	0,090	17,00
27 T5/28-2	28	6F	Al	44,62	43,75	48,0	21	27	32	—	8	18	0,092	17,30
27 T5/30-2	30	6F	Al	47,76	46,95	51,0	21	27	34	—	8	18	0,105	17,70
27 T5/32-2	32	6F	Al	50,94	50,10	54,0	21	27	38	—	8	22	0,123	18,60
27 T5/36-2	36	6F	Al	57,31	56,45	63,0	21	27	38	—	8	22	0,160	19,90
27 T5/40-2	40	6F	Al	63,66	62,85	66,0	21	27	40	—	8	23	0,193	22,50
27 T5/42-2	42	6F	Al	66,87	66,00	71,0	21	27	40	—	8	24	0,205	22,80
27 T5/44-0	44	6	Al	70,07	69,20	—	21	27	45	—	8	26	0,228	23,40
27 T5/48-0	48	6	Al	76,42	75,55	—	21	27	50	—	8	28	0,280	23,80
27 T5/60-0	60	6	Al	95,52	94,65	—	21	27	65	—	8	35	0,430	28,30

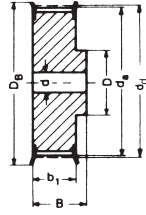

Ausf. Type 6F

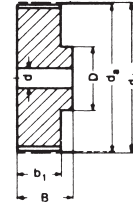

Ausf. Type 6

Type T 5 – Teilung Pitch 5 mm für Riemenbreite for belt width 25 mm

Bezeichnung Part No.	Anzahl der Zähne No. of teeth	Aus- führung Type	Material	d _d (mm)	d _a (mm)	D _B (mm)	b ₁ (mm)	B (mm)	D (mm)	D _i (mm)	Vor- bohrung Pilot bore d (mm)	Fertig- bohrung Finished bore d _{max} (mm)	Gewicht Weight (≈ kg)	€ Stück each
36 T5/10-2	10	6F	Al	15,92	15,05	19,5	30	36	8	—	—	5	0,023	14,80
36 T5/12-2	12	6F	Al	19,01	18,25	23,0	30	36	10	—	—	6	0,031	15,10
36 T5/14-2	14	6F	Al	22,29	21,45	25,0	30	36	13	—	—	8	0,037	15,10
36 T5/15-2	15	6F	Al	23,88	23,05	28,0	30	36	16	—	6	10	0,041	15,40
36 T5/16-2	16	6F	Al	25,47	24,60	32,0	30	36	18	—	6	11	0,050	15,70
36 T5/18-2	18	6F	Al	28,65	27,80	32,0	30	36	19	—	6	12	0,061	16,10
36 T5/19-2	19	6F	Al	30,25	29,40	36,0	30	36	22	—	6	12	0,070	16,40
36 T5/20-2	20	6F	Al	31,83	31,00	36,0	30	36	23	—	6	14	0,076	16,70
36 T5/22-2	22	6F	Al	35,12	34,25	38,0	30	36	24	—	6	15	0,080	17,70
36 T5/24-2	24	6F	Al	38,21	37,40	42,0	30	36	26	—	8	15	0,109	18,00
36 T5/25-2	25	6F	Al	39,80	39,00	44,0	30	36	26	—	8	15	0,116	18,60
36 T5/26-2	26	6F	Al	41,47	40,60	44,0	30	36	26	—	8	16	0,120	18,90
36 T5/27-2	27	6F	Al	42,98	42,20	48,0	30	36	30	—	8	18	0,128	19,30
36 T5/28-2	28	6F	Al	44,62	43,75	48,0	30	36	32	—	8	18	0,135	19,60
36 T5/30-2	30	6F	Al	47,76	46,95	51,0	30	36	34	—	8	18	0,150	19,90
36 T5/32-2	32	6F	Al	50,94	50,10	54,0	30	36	38	—	8	22	0,176	21,50
36 T5/36-2	36	6F	Al	57,31	56,45	63,0	30	36	38	—	8	22	0,230	22,50
36 T5/40-2	40	6F	Al	63,66	62,85	66,0	30	36	40	—	8	23	0,276	24,40
36 T5/42-2	42	6F	Al	66,87	66,00	71,0	30	36	40	—	8	24	0,284	24,80
36 T5/44-0	44	6	Al	70,07	69,20	—	30	36	45	—	8	26	0,315	26,00
36 T5/48-0	48	6	Al	76,42	75,55	—	30	36	50	—	8	28	0,400	27,90
36 T5/60-0	60	6	Al	95,52	94,65	—	30	36	65	—	8	35	0,614	34,00

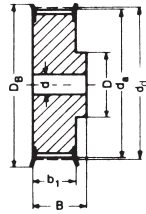

Ausf. Type 6F

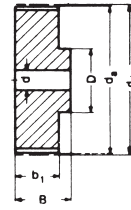

Ausf. Type 6

Type T 10 – Teilung Pitch 10 mm für Riemenbreite for belt width 16 mm

Bezeichnung Part No.	Anzahl der Zähne No. of teeth	Aus- führung Type	Material	d _d (mm)	d _a (mm)	D _B (mm)	b ₁ (mm)	B (mm)	D (mm)	D _i (mm)	Vor- bohrung Pilot bore d (mm)	Fertig- bohrung Finished bore d _{max} (mm)	Gewicht Weight (≈ kg)	€ Stück each
31 T10/12-2	12	6F	Al	38,20	36,35	42	21	31	28	—	6	16	0,076	15,10
31 T10/14-2	14	6F	Al	44,56	42,70	48	21	31	32	—	8	18	0,104	16,10
31 T10/15-2	15	6F	Al	47,75	45,90	51	21	31	32	—	8	18	0,116	16,70
31 T10/16-2	16	6F	Al	50,93	49,05	54	21	31	35	—	8	20	0,134	18,30
31 T10/18-2	18	6F	Al	57,29	55,45	60	21	31	40	—	8	22	0,167	19,30
31 T10/19-2	19	6F	Al	60,48	58,60	66	21	31	44	—	8	22	0,184	20,50
31 T10/20-2	20	6F	Al	63,66	61,80	66	21	31	46	—	8	24	0,208	21,80
31 T10/22-2	22	6F	Al	70,03	68,15	75	21	31	52	—	8	28	0,253	22,80
31 T10/24-2	24	6F	Al	76,39	74,55	83	21	31	58	—	8	30	0,288	25,70
31 T10/25-2	25	6F	Al	79,58	77,70	83	21	31	60	—	8	30	0,310	26,60
31 T10/26-2	26	6F	Al	82,76	80,90	87	21	31	60	—	8	30	0,357	27,90
31 T10/27-2	27	6F	Al	85,95	84,10	91	21	31	60	—	8	30	0,364	29,50
31 T10/28-2	28	6F	Al	89,13	87,25	93	21	31	60	—	8	30	0,401	30,80
31 T10/30-2	30	6F	Al	95,49	93,65	97	21	31	60	—	8	30	0,441	33,40
31 T10/32-2	32	6F	Al	101,86	100,00	106	21	31	65	—	10	32	0,493	39,20
31 T10/36-2	36	6F	Al	114,59	112,75	119	21	31	70	—	10	35	0,623	44,60
31 T10/40-2	40	6F	Al	127,32	125,45	131	21	31	80	—	10	40	0,767	56,20
31 T10/44-0	44	6	Al	140,06	138,20	—	21	31	88	—	10	46	0,993	60,40
31 T10/48-0	48	6	Al	152,78	150,95	—	21	31	95	—	16	48	1,090	67,10
31 T10/60-0	60	6	Al	190,98	189,10	—	21	31	110	—	16	60	1,710	95,00

Type T 10 – Teilung Pitch 10 mm für Riemenbreite for belt width 25 mm

40 T10/12-2	12	6F	Al	38,20	36,35	42	30	40	28	—	6	16	0,099	16,70
40 T10/14-2	14	6F	Al	44,56	42,70	48	30	40	32	—	8	18	0,134	18,90
40 T10/15-2	15	6F	Al	47,75	45,90	51	30	40	32	—	8	18	0,152	19,90
40 T10/16-2	16	6F	Al	50,93	49,05	54	30	40	35	—	8	20	0,176	21,50
40 T10/18-2	18	6F	Al	57,29	55,45	60	30	40	40	—	8	22	0,224	23,10
40 T10/19-2	19	6F	Al	60,48	58,60	66	30	40	44	—	8	22	0,247	24,40
40 T10/20-2	20	6F	Al	63,66	61,80	66	30	40	46	—	8	24	0,276	25,70
40 T10/22-2	22	6F	Al	70,03	68,15	75	30	40	52	—	8	28	0,337	27,00
40 T10/24-2	24	6F	Al	76,39	74,55	83	30	40	58	—	8	30	0,392	29,50
40 T10/25-2	25	6F	Al	79,58	77,70	83	30	40	60	—	8	30	0,422	31,10
40 T10/26-2	26	6F	Al	82,76	80,90	87	30	40	60	—	8	30	0,477	32,70
40 T10/27-2	27	6F	Al	85,95	84,10	91	30	40	60	—	8	30	0,536	34,00
40 T10/28-2	28	6F	Al	89,13	87,25	93	30	40	60	—	8	30	0,540	35,30
40 T10/30-2	30	6F	Al	95,49	93,65	97	30	40	60	—	8	30	0,640	38,80
40 T10/32-2	32	6F	Al	101,86	100,00	106	30	40	65	—	10	32	0,693	44,60
40 T10/36-2	36	6F	Al	114,59	112,75	119	30	40	70	—	10	35	0,873	52,00
40 T10/40-2	40	6F	Al	127,32	125,45	131	30	40	80	—	10	40	1,067	65,50
40 T10/44-0	44	6	Al	140,06	138,20	—	30	40	88	—	10	46	1,350	70,00
40 T10/48-0	48	6	Al	152,78	150,95	—	30	40	95	—	16	48	1,516	78,30
40 T10/60-0	60	6	Al	190,98	189,10	—	30	40	110	—	16	60	2,339	102,00

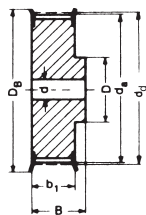

Ausf. Type 6F

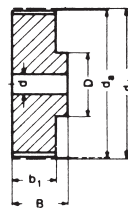

Ausf. Type 6

Type T 10 – Teilung Pitch 10 mm für Riemenbreite for belt width 32 mm

Bezeichnung Part No.	Anzahl der Zähne No. of teeth	Aus- führung Type	Material	d _d (mm)	d _a (mm)	D _B (mm)	b ₁ (mm)	B (mm)	D (mm)	D _i (mm)	Vor- bohrung Pilot bore d (mm)	Fertig- bohrung Finished bore d _{max} (mm)	Gewicht Weight (≈ kg)	€ Stück each
47 T10/18-2	18	6F	Al	57,29	55,45	60	37	47	40	—	10	22	0,253	26,30
47 T10/19-2	19	6F	Al	60,48	58,60	66	37	47	44	—	10	22	0,286	28,30
47 T10/20-2	20	6F	Al	63,66	61,80	66	37	47	46	—	12	24	0,322	30,50
47 T10/22-2	22	6F	Al	70,03	68,15	75	37	47	52	—	12	28	0,393	33,10
47 T10/24-2	24	6F	Al	76,39	74,55	83	37	47	58	—	12	30	0,475	34,40
47 T10/25-2	25	6F	Al	79,58	77,70	83	37	47	60	—	12	30	0,527	36,60
47 T10/26-2	26	6F	Al	82,76	80,90	87	37	47	60	—	12	30	0,564	39,80
47 T10/27-2	27	6F	Al	85,95	84,10	91	37	47	60	—	12	30	0,602	40,50
47 T10/28-2	28	6F	Al	89,13	87,25	93	37	47	60	—	12	30	0,642	41,40
47 T10/30-2	30	6F	Al	95,49	93,65	97	37	47	60	—	12	30	0,740	43,70
47 T10/32-2	32	6F	Al	101,86	100,00	106	37	47	65	—	12	32	0,844	49,80
47 T10/36-2	36	6F	Al	114,59	112,75	119	37	47	70	—	16	35	1,083	59,10
47 T10/40-2	40	6F	Al	127,32	125,45	131	37	47	80	—	16	40	1,317	73,80
47 T10/44-0	44	6	Al	140,06	138,20	—	37	47	88	—	16	46	1,611	81,20
47 T10/48-0	48	6	Al	152,78	150,95	—	37	47	95	—	16	48	1,931	90,50
47 T10/60-0	60	6	Al	190,98	189,10	—	37	47	110	—	16	60	3,004	119,00

Type T 10 – Teilung Pitch 10 mm für Riemenbreite for belt width 50 mm

66 T10/18-2	18	6F	Al	57,29	55,45	60	56	66	40	—	10	22	0,422	30,50
66 T10/19-2	19	6F	Al	60,48	58,60	66	56	66	44	—	10	22	0,466	32,70
66 T10/20-2	20	6F	Al	63,66	61,80	66	56	66	46	—	12	24	0,520	34,70
66 T10/22-2	22	6F	Al	70,03	68,15	75	56	66	52	—	12	28	0,570	38,50
66 T10/24-2	24	6F	Al	76,39	74,55	83	56	66	58	—	12	30	0,736	42,40
66 T10/25-2	25	6F	Al	79,58	77,70	83	56	66	60	—	12	30	0,766	44,00
66 T10/26-2	26	6F	Al	82,76	80,90	87	56	66	60	—	12	30	0,816	45,60
66 T10/27-2	27	6F	Al	85,95	84,10	91	56	66	60	—	12	30	0,946	47,50
66 T10/28-2	28	6F	Al	89,13	87,25	93	56	66	60	—	12	30	0,960	48,80
66 T10/30-2	30	6F	Al	95,49	93,65	97	56	66	60	—	12	30	1,169	53,90
66 T10/32-2	32	6F	Al	101,86	100,00	106	56	66	65	—	12	32	1,300	59,70
66 T10/36-2	36	6F	Al	114,59	112,75	119	56	66	70	—	16	35	1,637	76,10
66 T10/40-2	40	6F	Al	127,32	125,45	131	56	66	80	—	16	40	1,999	86,00
66 T10/44-0	44	6	Al	140,06	138,20	—	56	66	88	—	16	46	2,357	99,50
66 T10/48-0	48	6	Al	152,78	150,95	—	56	66	95	—	16	48	2,830	109,00
66 T10/60-0	60	6	Al	190,98	189,10	—	56	66	110	—	16	60	4,366	155,00

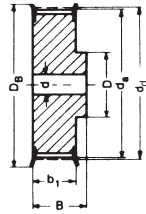

Ausf. Type 6F

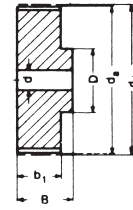

Ausf. Type 6

Type AT 5 – Teilung Pitch 5 mm für Riemenbreite for belt width 10 mm

Bezeichnung Part No.	Anzahl der Zähne No. of teeth	Aus- führung Type	Material	d _d (mm)	d _a (mm)	D _B (mm)	b ₁ (mm)	B (mm)	D (mm)	Vor- bohrung Pilot bore d (mm)	Fertig- bohrung Finished bore d _{max} (mm)	Gewicht Weight (= kg)	€ Stück each
21 AT 5/12-2	12	6F	Al	19,01	17,85	23,0	15	21	10	—	6	0,016	12,80
21 AT 5/14-2	14	6F	Al	22,29	21,05	25,0	15	21	13	—	8	0,019	13,50
21 AT 5/15-2	15	6F	Al	23,88	22,65	28,0	15	21	16	6	10	0,021	13,80
21 AT 5/16-2	16	6F	Al	25,47	24,20	32,0	15	21	18	6	11	0,025	14,50
21 AT 5/18-2	18	6F	Al	28,65	27,40	32,0	15	21	19	6	12	0,031	16,10
21 AT 5/19-2	19	6F	Al	30,25	29,00	36,0	15	21	22	6	12	0,036	16,40
21 AT 5/20-2	20	6F	Al	31,83	30,60	36,0	15	21	23	6	14	0,038	16,70
21 AT 5/22-2	22	6F	Al	35,12	33,85	38,0	15	21	24	6	15	0,046	17,30
21 AT 5/24-2	24	6F	Al	38,21	37,00	42,0	15	21	26	6	15	0,054	17,70
21 AT 5/25-2	25	6F	Al	39,80	38,60	44,0	15	21	26	6	15	0,058	18,00
21 AT 5/26-2	26	6F	Al	41,47	40,20	44,0	15	21	26	6	16	0,062	18,00
21 AT 5/27-2	27	6F	Al	42,98	41,80	48,0	15	21	30	8	18	0,064	18,20
21 AT 5/28-2	28	6F	Al	44,62	43,35	48,0	15	21	32	8	18	0,071	18,40
21 AT 5/30-2	30	6F	Al	47,76	46,55	51,0	15	21	34	8	18	0,075	18,60
21 AT 5/32-2	32	6F	Al	50,94	49,70	54,0	15	21	38	8	22	0,088	20,20
21 AT 5/36-2	36	6F	Al	57,31	56,05	63,0	15	21	38	8	22	0,114	21,80
21 AT 5/40-2	40	6F	Al	63,66	62,45	66,0	15	21	40	8	23	0,138	24,10
21 AT 5/42-2	42	6F	Al	66,87	65,60	71,0	15	21	40	8	24	0,180	24,40
21 AT 5/44-0	44	6	Al	70,07	68,80	—	15	21	45	8	26	0,185	24,70
21 AT 5/48-0	48	6	Al	76,42	75,15	—	15	21	50	8	28	0,200	27,60
21 AT 5/60-0	60	6	Al	95,52	94,25	—	15	21	65	8	35	0,307	31,80

Type AT 5 – Teilung Pitch 5 mm für Riemenbreite for belt width 16 mm

27 AT 5/12-2	12	6F	Al	19,01	17,85	23,0	21	27	10	—	6	0,022	13,80
27 AT 5/14-2	14	6F	Al	22,29	21,05	25,0	21	27	13	—	8	0,026	14,10
27 AT 5/15-2	15	6F	Al	23,88	22,65	28,0	21	27	16	6	10	0,029	14,50
27 AT 5/16-2	16	6F	Al	25,47	24,20	32,0	21	27	18	6	11	0,035	15,40
27 AT 5/18-2	18	6F	Al	28,65	27,40	32,0	21	27	19	6	12	0,043	16,70
27 AT 5/19-2	19	6F	Al	30,25	29,00	36,0	21	27	22	6	12	0,049	17,30
27 AT 5/20-2	20	6F	Al	31,83	30,60	36,0	21	27	23	6	14	0,053	18,00
27 AT 5/22-2	22	6F	Al	35,12	33,85	38,0	21	27	24	6	15	0,054	18,30
27 AT 5/24-2	24	6F	Al	38,21	37,00	42,0	21	27	26	6	15	0,076	18,60
27 AT 5/25-2	25	6F	Al	39,80	38,60	44,0	21	27	26	6	15	0,081	19,30
27 AT 5/26-2	26	6F	Al	41,47	40,20	44,0	21	27	26	6	16	0,085	19,60
27 AT 5/27-2	27	6F	Al	42,98	41,80	48,0	21	27	30	8	18	0,090	20,20
27 AT 5/28-2	28	6F	Al	44,62	43,35	48,0	21	27	32	8	18	0,092	20,50
27 AT 5/30-2	30	6F	Al	47,76	46,55	51,0	21	27	34	8	18	0,105	21,50
27 AT 5/32-2	32	6F	Al	50,94	49,70	54,0	21	27	38	8	22	0,123	22,50
27 AT 5/36-2	36	6F	Al	57,31	56,05	63,0	21	27	38	8	22	0,160	24,10
27 AT 5/40-2	40	6F	Al	63,66	62,45	66,0	21	27	40	8	23	0,193	26,60
27 AT 5/42-2	42	6F	Al	66,87	65,60	71,0	21	27	40	8	24	0,205	26,60
27 AT 5/44-0	44	6	Al	70,07	68,80	—	21	27	45	8	26	0,228	27,90
27 AT 5/48-0	48	6	Al	76,42	75,15	—	21	27	50	8	28	0,280	28,30
27 AT 5/60-0	60	6	Al	95,52	94,25	—	21	27	65	8	35	0,430	34,00

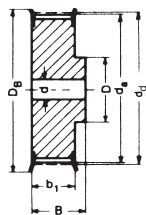

Ausf. Type 6F

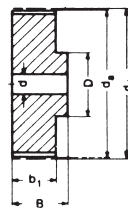

Ausf. Type 6

Type AT 5 – Teilung Pitch 5 mm für Riemenbreite for belt width 25 mm

Bezeichnung Part No.	Anzahl der Zähne No. of teeth	Aus- führung Type	Material	d _d (mm)	d _a (mm)	D _B (mm)	b ₁ (mm)	B (mm)	D (mm)	Vor- bohrung Pilot bore d (mm)	Fertig- bohrung Finished bore d _{max} (mm)	Gewicht Weight (= kg)	€ Stück each
36 AT 5/12-2	12	6F	Al	19,01	17,85	23,0	30	36	10	—	6	0,031	18,00
36 AT 5/14-2	14	6F	Al	22,29	21,05	25,0	30	36	13	—	8	0,037	18,00
36 AT 5/15-2	15	6F	Al	23,88	22,65	28,0	30	36	16	6	10	0,041	18,30
36 AT 5/16-2	16	6F	Al	25,47	24,20	32,0	30	36	18	6	11	0,050	18,60
36 AT 5/18-2	18	6F	Al	28,65	27,40	32,0	30	36	19	6	12	0,061	19,30
36 AT 5/19-2	19	6F	Al	30,25	29,00	36,0	30	36	22	6	12	0,070	19,60
36 AT 5/20-2	20	6F	Al	31,83	30,60	36,0	30	36	23	6	14	0,076	19,90
36 AT 5/22-2	22	6F	Al	35,12	33,85	38,0	30	36	24	6	15	0,080	21,50
36 AT 5/24-2	24	6F	Al	38,21	37,00	42,0	30	36	26	8	15	0,109	21,80
36 AT 5/25-2	25	6F	Al	39,80	38,60	44,0	30	36	26	8	15	0,116	22,50
36 AT 5/26-2	26	6F	Al	41,47	40,20	44,0	30	36	26	8	16	0,120	22,80
36 AT 5/27-2	27	6F	Al	42,98	41,80	48,0	30	36	30	8	18	0,128	23,40
36 AT 5/28-2	28	6F	Al	44,62	43,35	48,0	30	36	32	8	18	0,135	23,80
36 AT 5/30-2	30	6F	Al	47,76	46,55	51,0	30	36	34	8	18	0,150	24,10
36 AT 5/32-2	32	6F	Al	50,94	49,70	54,0	30	36	38	8	22	0,176	25,70
36 AT 5/36-2	36	6F	Al	57,31	56,05	63,0	30	36	38	8	22	0,230	26,60
36 AT 5/40-2	40	6F	Al	63,66	62,45	66,0	30	36	40	8	23	0,276	29,50
36 AT 5/42-2	42	6F	Al	66,87	65,60	71,0	30	36	40	8	24	0,284	29,90
36 AT 5/44-0	44	6	Al	70,07	68,80	—	30	36	45	8	26	0,315	31,50
36 AT 5/48-0	48	6	Al	76,42	75,15	—	30	36	50	8	28	0,400	33,70
36 AT 5/60-0	60	6	Al	95,52	94,25	—	30	36	65	8	35	0,614	40,80

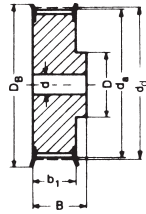

Ausf. Type 6F

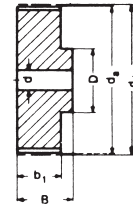

Ausf. Type 6

Type AT 10 – Teilung Pitch 10 mm für Riemenbreite for belt width 16 mm

Bezeichnung Part No.	Anzahl der Zähne No. of teeth	Aus- führung Type	Material	d _d (mm)	d _a (mm)	D _B (mm)	b ₁ (mm)	B (mm)	D (mm)	Vor- bohrung Pilot bore d (mm)	Fertig- bohrung Finished bore d _{max} (mm)	Gewicht Weight (= kg)	€ Stück each
31 AT 10/15-2	15	6F	Al	47,75	45,90	51	21	31	32	8	18	0,116	19,90
31 AT 10/16-2	16	6F	Al	50,93	49,05	54	21	31	35	8	20	0,134	22,20
31 AT 10/18-2	18	6F	Al	57,29	55,45	60	21	31	40	8	22	0,167	23,40
31 AT 10/19-2	19	6F	Al	60,48	58,60	66	21	31	44	8	22	0,184	24,70
31 AT 10/20-2	20	6F	Al	63,66	61,80	66	21	31	46	8	24	0,208	26,00
31 AT 10/22-2	22	6F	Al	70,03	68,15	75	21	31	52	8	28	0,253	27,30
31 AT 10/24-2	24	6F	Al	76,39	74,55	83	21	31	58	8	30	0,288	30,80
31 AT 10/25-2	25	6F	Al	79,58	77,70	83	21	31	60	8	30	0,310	32,10
31 AT 10/26-2	26	6F	Al	82,76	80,90	87	21	31	60	8	30	0,357	33,70
31 AT 10/27-2	27	6F	Al	85,95	84,10	91	21	31	60	8	30	0,364	35,30
31 AT 10/28-2	28	6F	Al	89,13	87,25	93	21	31	60	8	30	0,401	36,60
31 AT 10/30-2	30	6F	Al	95,49	93,65	97	21	31	60	8	30	0,441	40,10
31 AT 10/32-2	32	6F	Al	101,86	100,00	106	21	31	65	10	32	0,493	46,90
31 AT 10/36-2	36	6F	Al	114,59	112,75	119	21	31	70	10	35	0,623	53,60
31 AT 10/40-2	40	6F	Al	127,32	125,45	131	21	31	80	10	40	0,767	67,40
31 AT 10/44-0	44	6	Al	140,06	138,20	—	21	31	88	10	46	0,993	72,60
31 AT 10/48-0	48	6	Al	152,78	150,95	—	21	31	95	16	48	1,090	80,60
31 AT 10/60-0	60	6	Al	190,98	189,10	—	21	31	110	16	60	1,710	114,00

Type AT 10 – Teilung Pitch 10 mm für Riemenbreite for belt width 25 mm

40 AT 10/15-2	15	6F	Al	47,75	45,90	51	30	40	32	8	18	0,152	24,10
40 AT 10/16-2	16	6F	Al	50,93	49,05	54	30	40	35	8	20	0,176	25,70
40 AT 10/18-2	18	6F	Al	57,29	55,45	60	30	40	40	8	22	0,224	27,60
40 AT 10/19-2	19	6F	Al	60,48	58,60	66	30	40	44	8	22	0,247	29,50
40 AT 10/20-2	20	6F	Al	63,66	61,80	66	30	40	46	8	24	0,276	30,80
40 AT 10/22-2	22	6F	Al	70,03	68,15	75	30	40	52	8	28	0,337	32,40
40 AT 10/24-2	24	6F	Al	76,39	74,55	83	30	40	58	8	30	0,392	35,30
40 AT 10/25-2	25	6F	Al	79,58	77,70	83	30	40	60	8	30	0,422	37,20
40 AT 10/26-2	26	6F	Al	82,76	80,90	87	30	40	60	8	30	0,477	39,50
40 AT 10/27-2	27	6F	Al	85,95	84,10	91	30	40	60	8	30	0,536	40,80
40 AT 10/28-2	28	6F	Al	89,13	87,25	93	30	40	60	8	30	0,540	42,40
40 AT 10/30-2	30	6F	Al	95,49	93,65	97	30	40	60	8	30	0,640	46,60
40 AT 10/32-2	32	6F	Al	101,86	100,00	106	30	40	65	10	32	0,693	53,60
40 AT 10/36-2	36	6F	Al	114,59	112,75	119	30	40	70	10	35	0,873	62,30
40 AT 10/40-2	40	6F	Al	127,32	125,45	131	30	40	80	10	40	1,067	78,30
40 AT 10/44-0	44	6	Al	140,06	138,20	—	30	40	88	10	46	1,350	84,10
40 AT 10/48-0	48	6	Al	152,78	150,95	—	30	40	95	16	48	1,516	94,10
40 AT 10/60-0	60	6	Al	190,98	189,10	—	30	40	110	16	60	2,339	123,00

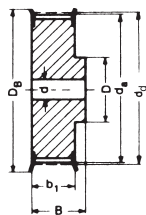

Ausf. Type 6F

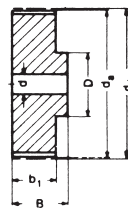

Ausf. Type 6

Type AT 10 – Teilung Pitch 10 mm für Riemenbreite for belt width 32 mm

Bezeichnung Part No.	Anzahl der Zähne No. of teeth	Aus- führung Type	Material	d _d (mm)	d _a (mm)	D _B (mm)	b ₁ (mm)	B (mm)	D (mm)	Vor- bohrung Pilot bore d (mm)	Fertig- bohrung Finished bore d _{max} (mm)	Gewicht Weight (= kg)	€ Stück each
47 AT 10/18-2	18	6F	Al	57,29	55,45	60	37	47	40	10	22	0,253	31,80
47 AT 10/19-2	19	6F	Al	60,48	58,60	66	37	47	44	10	22	0,286	34,00
47 AT 10/20-2	20	6F	Al	63,66	61,80	66	37	47	46	12	24	0,322	36,30
47 AT 10/22-2	22	6F	Al	70,03	68,15	75	37	47	52	12	28	0,393	39,80
47 AT 10/24-2	24	6F	Al	76,39	74,55	83	37	47	58	12	30	0,475	41,40
47 AT 10/25-2	25	6F	Al	79,58	77,70	83	37	47	60	12	30	0,527	44,00
47 AT 10/26-2	26	6F	Al	82,76	80,90	87	37	47	60	12	30	0,564	47,80
47 AT 10/27-2	27	6F	Al	85,95	84,10	91	37	47	60	12	30	0,602	48,50
47 AT 10/28-2	28	6F	Al	89,13	87,25	93	37	47	60	12	30	0,642	49,80
47 AT 10/30-2	30	6F	Al	95,49	93,65	97	37	47	60	12	30	0,740	52,30
47 AT 10/32-2	32	6F	Al	101,86	100,00	106	37	47	65	12	32	0,844	59,70
47 AT 10/36-2	36	6F	Al	114,59	112,75	119	37	47	70	16	35	1,083	70,60
47 AT 10/40-2	40	6F	Al	127,32	125,45	131	37	47	80	16	40	1,317	88,60
47 AT 10/44-0	44	6	Al	140,06	138,20	—	37	47	88	16	46	1,611	97,60
47 AT 10/48-0	48	6	Al	152,78	150,95	—	37	47	95	16	48	1,931	108,00
47 AT 10/60-0	60	6	Al	190,98	189,10	—	37	47	110	16	60	3,004	142,00

Type AT 10 – Teilung Pitch 10 mm für Riemenbreite for belt width 50 mm

66 AT 10/18-2	18	6F	Al	57,29	55,45	60	56	66	40	10	22	0,422	36,30
66 AT 10/19-2	19	6F	Al	60,48	58,60	66	56	66	44	10	22	0,466	39,50
66 AT 10/20-2	20	6F	Al	63,66	61,80	66	56	66	46	12	24	0,520	41,70
66 AT 10/22-2	22	6F	Al	70,03	68,15	75	56	66	52	12	28	0,570	46,20
66 AT 10/24-2	24	6F	Al	76,39	74,55	83	56	66	58	12	30	0,736	50,70
66 AT 10/25-2	25	6F	Al	79,58	77,70	83	56	66	60	12	30	0,766	52,60
66 AT 10/26-2	26	6F	Al	82,76	80,90	87	56	66	60	12	30	0,816	54,90
66 AT 10/27-2	27	6F	Al	85,95	84,10	91	56	66	60	12	30	0,946	56,80
66 AT 10/28-2	28	6F	Al	89,13	87,25	93	56	66	60	12	30	0,960	58,40
66 AT 10/30-2	30	6F	Al	95,49	93,65	97	56	66	60	12	30	1,169	64,80
66 AT 10/32-2	32	6F	Al	101,86	100,00	106	56	66	65	12	32	1,300	71,90
66 AT 10/36-2	36	6F	Al	114,59	112,75	119	56	66	70	16	35	1,637	91,50
66 AT 10/40-2	40	6F	Al	127,32	125,45	131	56	66	80	16	40	1,999	103,00
66 AT 10/44-0	44	6	Al	140,06	138,20	—	56	66	88	16	46	2,357	120,00
66 AT 10/48-0	48	6	Al	152,78	150,95	—	56	66	95	16	48	2,830	132,00
66 AT 10/60-0	60	6	Al	190,98	189,10	—	56	66	110	16	60	4,366	186,00

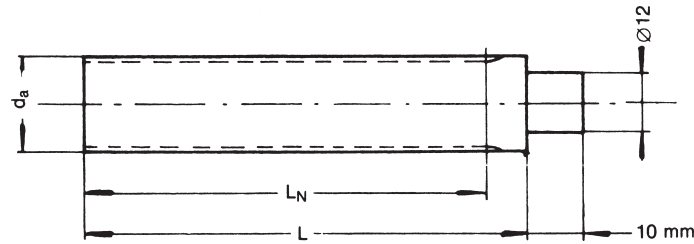

Type XL – Teilung Pitch 5,08 mm (1/5")

Bezeichnung Part No.	Anzahl der Zähne No. of teeth	Material	d_d (mm)	d_a (mm)	L_N (mm)	L (mm)	€ Stück each
10 XL 125	10	St	16,17	15,66	125	140	21,10
11 XL 125	11	St	17,79	17,28	125	140	21,30
12 XL 125	12	St	19,40	18,89	125	140	23,70
13 XL 125	13	St	21,02	20,51	125	140	25,50
14 XL 132	14	St	22,64	22,13	132	140	27,50
15 XL 132	15	St	24,26	23,75	132	140	28,30
16 XL 140	16	St	25,87	25,36	140	140	30,50
17 XL 140	17	St	27,49	26,98	140	140	32,60
18 XL 140	18	St	29,11	28,60	140	140	32,90
19 XL 140	19	St	30,72	30,21	140	140	36,00
20 XL 140	20	St	32,34	31,83	140	140	39,20
21 XL 160	21	St	33,96	33,45	160	160	40,80
22 XL 160	22	St	35,57	35,06	160	160	42,60
23 XL 160	23	St	37,19	36,68	160	160	44,70
24 XL 160	24	St	38,81	38,30	160	160	47,00
25 XL 160	25	St	40,43	39,92	160	160	51,70
26 XL 160	26	St	42,04	41,53	160	160	54,90
27 XL 160	27	St	43,66	43,15	160	160	57,10
28 XL 160	28	St	45,28	44,77	160	160	59,00
29 XL 160	29	St	46,89	46,38	160	160	60,70
30 XL 160	30	St	48,51	48,00	160	160	62,40
32 XL 160	32	Al	51,74	51,23	160	160	76,10
33 XL 160	33	Al	53,36	52,76	160	160	80,60
34 XL 160	34	Al	54,98	54,47	160	160	86,00
35 XL 160	35	Al	56,60	56,09	160	160	87,60
36 XL 160	36	Al	58,21	57,70	160	160	90,00
38 XL 160	38	Al	61,45	60,94	160	160	99,40
39 XL 160	39	Al	63,06	62,55	160	160	105,00
40 XL 160	40	Al	64,68	64,17	160	160	112,00
41 XL 160	41	Al	66,30	65,79	160	160	116,00
42 XL 160	42	Al	67,91	67,40	160	160	116,00
43 XL 160	43	Al	69,53	69,02	160	160	124,00
44 XL 160	44	Al	71,15	70,64	160	160	126,00
48 XL 160	48	Al	77,62	77,11	160	160	143,00
56 XL 160	56	Al	90,55	90,04	160	160	167,00
60 XL 160	60	Al	97,02	96,51	160	160	194,00
72 XL 160	72	Al	116,43	115,92	160	160	285,00

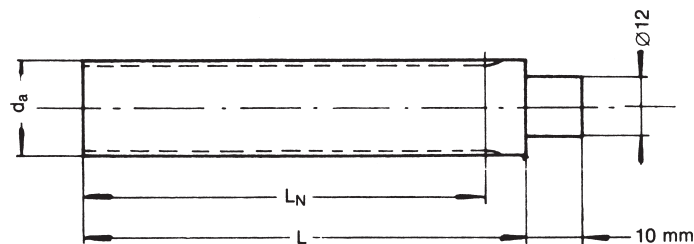

Type L – Teilung Pitch 9,525 mm ($\frac{3}{8}$ ")

Bezeichnung Part No.	Anzahl der Zähne No. of teeth	Material	d_d (mm)	d_a (mm)	L_N (mm)	L (mm)	€ Stück each
10 L 140	10	St	30,32	29,56	140	140	27,00
11 L 140	11	St	33,35	32,59	140	140	30,20
12 L 160	12	St	36,38	35,62	160	160	32,20
13 L 160	13	St	39,41	38,65	160	160	35,60
14 L 160	14	St	42,45	41,68	160	160	36,10
15 L 160	15	St	45,48	44,72	160	160	39,10
16 L 160	16	St	48,51	47,75	160	160	43,40
17 L 160	17	St	51,54	50,78	160	160	50,50
18 L 160	18	St	54,57	53,81	160	160	53,50
19 L 160	19	St	57,61	56,84	160	160	54,30
20 L 160	20	St	60,64	59,88	160	160	58,10
21 L 160	21	St	63,67	62,91	160	160	59,10
22 L 160	22	St	66,70	65,94	160	160	62,50
23 L 160	23	St	69,73	68,97	160	160	67,70
24 L 160	24	St	72,77	72,00	160	160	69,10
27 L 160	27	St	81,86	81,10	160	160	116,00
30 L 160	30	St	90,96	90,20	160	160	149,00

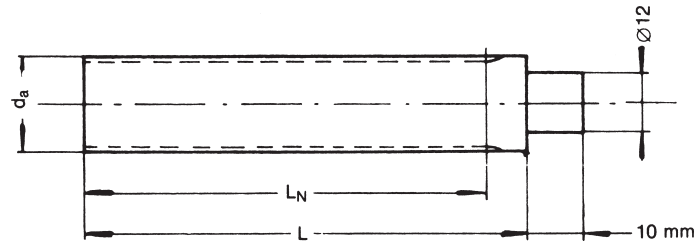

Type T 5 – Teilung Pitch 5 mm

Bezeichnung Part No.	Anzahl der Zähne No. of teeth	Material	d_d (mm)	d_a (mm)	L_N (mm)	L (mm)	€ Stück each
125 T 5- 10	10	Al	15,92	15,05	125	140	18,80
125 T 5- 11	11	Al	17,51	16,65	125	140	19,90
125 T 5- 12	12	Al	19,01	18,25	125	140	21,00
125 T 5- 13	13	Al	20,70	19,85	125	140	21,60
132 T 5- 14	14	Al	22,29	21,45	132	140	22,40
132 T 5- 15	15	Al	23,88	23,05	132	140	23,00
140 T 5- 16	16	Al	25,47	24,60	140	140	25,20
140 T 5- 17	17	Al	27,06	26,20	140	140	27,00
140 T 5- 18	18	Al	28,65	27,80	140	140	29,20
140 T 5- 19	19	Al	30,25	29,40	140	140	31,50
160 T 5- 20	20	Al	31,83	31,00	160	160	33,70
160 T 5- 21	21	Al	33,43	32,70	160	160	36,30
160 T 5- 22	22	Al	35,12	34,25	160	160	38,70
160 T 5- 23	23	Al	36,62	35,85	160	160	40,60
160 T 5- 24	24	Al	38,21	37,40	160	160	42,40
160 T 5- 25	25	Al	39,80	39,00	160	160	43,90
160 T 5- 26	26	Al	41,47	40,60	160	160	47,20
160 T 5- 27	27	Al	42,98	42,20	160	160	50,40
160 T 5- 28	28	Al	44,62	43,75	160	160	53,20
160 T 5- 29	29	Al	46,17	45,35	160	160	55,50
160 T 5- 30	30	Al	47,76	46,95	160	160	57,90
160 T 5- 32	32	Al	50,94	50,10	160	160	61,50
160 T 5- 34	34	Al	54,13	53,25	160	160	68,00
160 T 5- 35	35	Al	55,72	54,85	160	160	72,30
160 T 5- 36	36	Al	57,31	56,45	160	160	76,40
160 T 5- 37	37	Al	58,90	58,06	160	160	80,80
160 T 5- 38	38	Al	60,50	59,65	160	160	84,00
160 T 5- 40	40	Al	63,66	62,85	160	160	85,50
160 T 5- 42	42	Al	66,87	66,00	160	160	93,40
160 T 5- 44	44	Al	70,07	69,20	160	160	102,00
160 T 5- 45	45	Al	71,64	70,80	160	160	105,00
160 T 5- 46	46	Al	73,23	72,40	160	160	108,00
160 T 5- 48	48	Al	76,42	75,55	160	160	113,00
160 T 5- 50	50	Al	79,60	78,75	160	160	122,00
160 T 5- 60	60	Al	95,52	94,65	160	160	165,00
160 T 5- 72	72	Al	114,62	113,75	160	160	223,00
160 T 5- 80	80	Al	127,36	126,48	160	160	262,00
160 T 5- 90	90	Al	143,28	142,40	160	160	320,00
160 T 5-100	100	Al	159,20	158,31	160	160	353,00

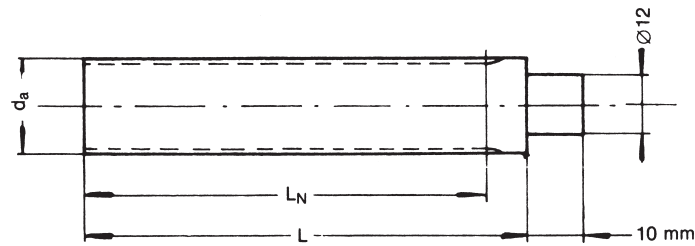

Type T 10 – Teilung Pitch 10 mm

Bezeichnung Part No.	Anzahl der Zähne No. of teeth	Material	d_d (mm)	d_a (mm)	L_N (mm)	L (mm)	€ Stück each
140 T 10-10	10	Al	31,83	29,98	140	140	26,50
140 T 10-11	11	Al	35,01	33,16	140	140	30,00
140 T 10-12	12	Al	38,20	36,35	140	140	33,30
140 T 10-13	13	Al	41,38	39,50	140	140	37,30
160 T 10-14	14	Al	44,56	42,70	160	160	43,30
160 T 10-15	15	Al	47,75	45,90	160	160	49,50
160 T 10-16	16	Al	50,93	49,05	160	160	56,50
160 T 10-17	17	Al	54,11	52,25	160	160	59,60
160 T 10-18	18	Al	57,29	55,45	160	160	65,10
160 T 10-19	19	Al	60,48	58,60	160	160	68,40
160 T 10-20	20	Al	63,66	61,60	160	160	74,20
160 T 10-21	21	Al	66,84	65,00	160	160	80,30
160 T 10-22	22	Al	70,03	68,15	160	160	85,40
160 T 10-23	23	Al	73,20	71,35	160	160	92,00
160 T 10-24	24	Al	76,39	74,55	160	160	102,00
160 T 10-26	26	Al	82,76	80,90	160	160	114,00
160 T 10-28	28	Al	89,13	87,25	160	160	128,00
160 T 10-30	30	Al	95,49	93,65	160	160	142,00
160 T 10-32	32	Al	101,86	100,00	160	160	173,00
160 T 10-34	34	Al	108,22	106,40	160	160	197,00
160 T 10-36	36	Al	114,59	112,75	160	160	209,00
160 T 10-38	38	Al	120,95	119,10	160	160	236,00
160 T 10-40	40	Al	127,32	125,45	160	160	260,00
160 T 10-45	45	Al	143,24	141,40	160	160	335,00
160 T 10-48	48	Al	152,78	150,95	160	160	378,00
160 T 10-60	60	Al	190,98	189,10	160	160	595,00
160 T 10-72	72	Al	229,18	227,29	160	160	727,00



optibelt TV Anschraubnaben – Bolt on hubs

Bezeichnung Part No.	Material	Taper- Buchse Taper bush	D _A (mm)	D _T (mm)	D + 0/- 0,1 (mm)	D _K (mm)	B (mm)	b (mm)	Z (mm)	B _M (mm)	d (mm)	Gewicht o. Buchse Weight without bush (≈ kg)	€ Stück ohne Buchse each without bush
SM 12	GG	1210	180	135	90	75	25	6,5	2,5	11,5	6 x 7,5	1,5	36,60
SM 16	GG	1615	200	150	110	85	38	7,5	2,5	12,5	6 x 7,5	3,0	42,60
SM 20	GG	2012	270	190	140	110	32	8,5	2,5	13,5	6 x 9,5		61,20
SM 25	GG	2517	340	240	170	125	45	9,5	2,5	14,5	8 x 11,5	7,6	95,60
SM 30-1	GG	3020	430	300	220	160	51	13,5	2,5	18,5	8 x 13,5	16,6	137,00
SM 30-2	GG	3020	485	340	250	160	51	13,5	2,5	18,5	8 x 13,5	20,5	216,00

optibelt TV Einschweißnaben Type WM – Weld on hubs type WM

Bezeichnung Part No.	Material	Taper- Buchse Taper bush	D _A (mm)	D + 0/- 0,05 (mm)	D _K (mm)	B + 0,5/- 0,05 (mm)	b ₁ (mm)	b ₂ (mm)	Gewicht ohne Buchse Weight without bush (≈ kg)	€ Stück ohne Buchse each without bush
WM 1210	St	1210	70	60	58	25	9	10	0,3	27,40
WM 1615	St	1615	83	70	68	38	16	11	0,6	33,80
WM 2012	St	2012	95	90	88	32	12	12	0,7	35,50
WM 2517	St	2517	127	110	108	44	19	13	1,8	44,20
WM 3030	St	3030	152	130	125	76	25	19	3,5	79,00
WM 3535	St	3535	184	155	151	89	32	25	10,0	141,00
WM 4040	St	4040	225	195	187	102	32	32	13,2	202,00
WM 4545	St	4545	254	220	213	115	38	38	20,1	314,00
WM 5050	St	5050	276	242	228	127	38	38	25,4	486,00

optibelt TV Einschweißnaben Type WH – Weld on hubs type WH

Bezeichnung Part No.	Material	Taper- Buchse Taper bush	D _A (mm)	D + 0/- 0,05 (mm)	D _K (mm)	B + 0,5/- 0,05 (mm)	b ₁ (mm)	b ₂ (mm)	Gewicht ohne Buchse Weight without bush (≈ kg)	€ Stück ohne Buchse each without bush
WH 1210	St	1210	70	65	64,5	25	9	10	0,3	27,40
WH 1610	St	1610	80	75	74,5	25	9	10		33,80
WH 2012	St	2012	95	90	89,5	32	12	12		35,50
WH 2517	St	2517	115	110	109,5	44	19	15		44,20
WH 3020	St	3020	145	140	139,5	50	19	15	2,7	79,00
WH 3525	St	3525	190	180	179,5	65	25	25		109,00
WH 3535	St	3535	190	180	179,5	89	32	25	10,0	141,00
WH 4040	St	4040	200	190	189,5	101	32	30		202,00
WH 4545	St	4545	210	200	199,5	115	40	30		314,00
WH 5050	St	5050	230	220	219,5	127	40	35		486,00

Taper-Buchse Taper bush	1210	1610	1615	2012	2517	3020	3030	3525	3535	4040	4545	5050
Bohrung d ₂ (mm) von ... bis ... Bore d ₂ (mm) from ... to ...	11-32	14-42	14-42	14-50	16-60	25-75	35-75	35-90	35-90	40-100	44-110	70-125
€/Stück each	9,20	11,00	11,50	13,50	16,90	22,00	28,80	58,50	55,50	78,00	99,30	159,00

Bohrungsdurchmesser d₂ siehe Seite 3.
Bore diameters d₂ see page 3.

Weitere Abmessungen auf Anfrage.
Further sizes on request.

GG = Grauguss
GG = Cast iron

St = Stahl
St = Steel

Fertigungstechnische Änderungen vorbehalten.
We reserve the right to make technical changes.

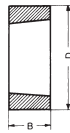

Bezeichnung Part No.	Material	Taper- Buchse Taper bush	D (mm)	B (mm)	Nut- querschnitt Keyway dimensions b x h (mm)	minimaler Nabendurchmesser der Scheibe Minimum hub diameter			Gewicht ohne Buchse Weight without bush (≈ kg)	€ Stück ohne Buchse each without bush
						Material				
						GG	GGG	St		
1008 AM 1008 BM	St St	1008 1008	45 45	22 22	5 x 2,5	71 75	62 67	56 60	0,1 0,1	22,40 22,40
1210 AM 1210 BM	St St	1210 1210	60 60	25 25	6 x 3	86 92	79 86	73 83	0,2 0,2	33,60 35,10
1610 AM 1610 BM	St St	1610 1610	70 70	25 25	10 x 4	95 102	89 95	83 89	0,3 0,3	40,30 41,80
1615 AM 1615 BM	St St	1615 1615	70 70	38 38	10 x 4	95 102	89 95	83 89	0,4 0,4	44,10 45,60
2517 AM 2517 BM	St St	2517 2517	105 105	45 45	16 x 4	143 149	133 140	121 127	1,0 1,0	59,00 59,70
3030 AM 3030 BM	St St	3030 3030	130 130	76 76	20 x 5	178 187	165 175	156 159	2,5 2,5	102,00 104,00
3535 AM 3535 BM	St St	3535 3535	160 160	89 89	22 x 5	222 232	203 213	191 200	5,2 5,2	166,00 169,00
4040 AM 4040 BM	St St	4040 4040	185 185	102 102	24 x 5	273 283	248 257	229 238	8,0 8,0	203,00 207,00

St = Stahl Steel GG = Grauguss Cast iron GGG = Globularer Grauguss Spheroidal graphite cast iron AM = ohne Keilnut without keyway BM = mit Keilnut with keyway

Taper-Buchse Taper bush	1008	1210	1610	1615	2517	3030	3535	4040
Bohrung d ₂ (mm) von ... bis ... Bore d ₂ (mm) from ... to ...	10-25	11-32	14-42	14-42	16-60	35-75	35-90	40-100
€/Stück each	6,10	9,20	11,00	11,50	16,90	28,80	55,50	78,00

Bohrungsdurchmesser d₂ siehe Seite 3. Bore diameters d₂ see page 3. Weitere Abmessungen auf Anfrage. Further sizes on request. Fertigungstechnische Änderungen vorbehalten. We reserve the right to make technical changes.

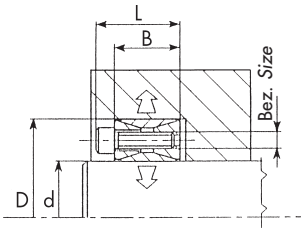

Type CE01

Bezeichnung Part No.	Abmessung Dimension				Schrauben Screws			bei Anzugsmoment M _s übertragbar with tightening torque M _s applied		Flächen- pression Pressure		Gewicht Weight (kg)	€/Stück each
	d	D	B	L	Bezeichnung Part No.	Anzahl No. Stück each	Anzugs- moment Tightening torque M _s (N _m)	Drehmoment Torque	Axialkraft Axial force	Welle Shaft	Nabe Hub		
								M	F	P _w	P _N		
								(N _m)	(K _N)	(N/ mm ²)	(N/ mm ²)		
CE01- 18	18	47	20	26	M 6 x 18	8	16	250	28	240	92	0,210	27,20
CE01- 19	19	47	20	26	M 6 x 18	8	16	260	28	225	92	0,210	27,20
CE01- 20	20	47	20	26	M 6 x 18	8	16	280	28	215	92	0,210	27,20
CE01- 22	22	47	20	26	M 6 x 18	8	16	310	28	195	92	0,200	27,20
CE01- 24	24	50	20	26	M 6 x 18	8	16	330	28	180	87	0,222	28,40
CE01- 25	25	50	20	26	M 6 x 18	8	16	350	28	175	87	0,220	28,40
CE01- 28	28	55	20	26	M 6 x 18	12	16	580	42	230	118	0,266	29,60
CE01- 30	30	55	20	26	M 6 x 18	12	16	630	42	215	118	0,254	29,60
CE01- 32	32	60	20	26	M 6 x 18	12	16	670	42	200	110	0,302	32,60
CE01- 35	35	60	20	26	M 6 x 18	12	16	730	42	185	110	0,282	32,60
CE01- 38	38	65	20	26	M 6 x 18	15	16	990	52	215	125	0,328	35,20
CE01- 40	40	65	20	26	M 6 x 18	15	16	1040	52	200	125	0,318	35,20
CE01- 42	42	75	24	32	M 8 x 22	12	38	1600	76	240	140	0,560	40,20
CE01- 45	45	75	24	32	M 8 x 22	12	38	1700	76	225	140	0,528	40,20
CE01- 48	48	80	24	32	M 8 x 22	12	38	1800	76	210	120	0,590	43,00
CE01- 50	50	80	24	32	M 8 x 22	12	38	1900	76	200	130	0,560	43,00
CE01- 55	55	85	24	32	M 8 x 22	15	38	2600	95	230	150	0,622	43,00
CE01- 60	60	90	24	32	M 8 x 22	15	38	2850	95	210	140	0,660	48,60
CE01- 65	65	95	24	32	M 8 x 22	15	38	3100	95	195	130	0,798	50,60
CE01- 70	70	110	28	38	M10 x 25	15	75	5350	150	240	160	1,238	71,40
CE01- 75	75	115	28	38	M10 x 25	15	75	5730	150	225	150	1,294	74,00
CE01- 80	80	120	28	38	M10 x 25	15	75	6100	150	210	140	1,364	75,50
CE01- 85	85	125	28	38	M10 x 25	15	75	6500	150	200	140	1,428	89,40
CE01- 90	90	130	28	38	M10 x 25	15	75	6900	150	185	130	1,482	91,60
CE01- 95	95	135	28	38	M10 x 25	18	75	8700	180	210	150	1,568	95,80
CE01-100	100	145	30	42	M12 x 30	15	130	11200	220	230	160	2,154	113,00
CE01-110	110	155	30	42	M12 x 30	15	130	12300	220	205	150	2,306	118,00
CE01-120	120	165	30	42	M12 x 30	16	130	14300	240	200	150	2,486	122,00
CE01-130	130	180	38	50	M12 x 35	20	130	19400	300	180	130	3,586	175,00
CE01-140	140	190	38	50	M12 x 35	22	130	23000	330	180	140	3,810	188,00
CE01-150	150	200	38	50	M12 x 35	24	130	26900	360	185	140	4,084	208,00
CE01-160	160	210	38	50	M12 x 35	26	130	31000	390	190	150	4,360	231,00
CE01-170	170	225	44	58	M14 x 40	22	200	36300	430	175	140	5,700	264,00
CE01-180	180	235	44	58	M14 x 40	24	200	42000	470	180	140	6,000	296,00
CE01-190	190	250	52	66	M14 x 45	28	200	51800	550	165	130	8,000	400,00
CE01-200	200	260	52	66	M14 x 45	30	200	58300	590	165	130	8,200	433,00
CE01-220*	220	285	56	72	M16 x 50	26	300	74100	680	160	130	11,000	544,00
CE01-240*	240	305	56	72	M16 x 50	30	300	93200	780	170	140	12,300	603,00
CE01-260*	260	325	56	72	M16 x 50	34	300	114500	890	180	150	13,000	847,00
CE01-280*	280	355	66	84	M18 x 60	32	410	141000	1000	160	130	19,000	1.071,00
CE01-300*	300	375	66	84	M18 x 60	36	410	170000	1140	165	140	20,200	1.232,00
CE01-320*	320	405	78	98	M20 x 70	36	590	235500	1500	170	140	30,600	} auf Anfrage on request
CE01-340*	340	425	78	98	M20 x 70	36	590	250000	1500	160	130	30,800	
CE01-360*	360	455	90	112	M22 x 80	36	790	329000	1800	160	130	43,200	
CE01-380*	380	475	90	112	M22 x 80	36	790	346400	1800	150	120	45,000	
CE01-400*	400	495	90	112	M22 x 80	36	790	365000	1800	145	120	46,800	

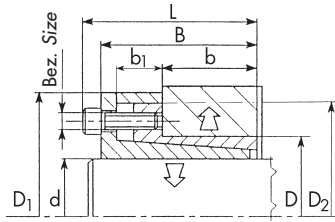

Type CE02

Bezeichnung Part No.	Abmessung Dimension								Schrauben Screws			bei Anzugsmoment M _s übertragbar with tightening torque M _s applied		Flächen- pression Pressure		Gewicht Weight	€/Stück each				
	d	D	D ₁	D ₂	b	b ₁	B	L	Bezeichnung Part No.	Anzahl No.	Anzugs- moment Tightening torque M _s	M	F	Welle Shaft	Nabe Hub						
																		Drehmoment Torque	Axialkraft Axial force	P _w	P _N
																		(N _m)	(K _N)	(N/ mm ²)	(N/ mm ²)
(mm)	(mm)	(mm)	(mm)	(mm)	(mm)	(mm)	(mm)	Stück each	(N _m)	(K _N)	(N/ mm ²)	(N/ mm ²)	(kg)								
CE02- 6*	6	14	25	23	9	9,5	21,5	24,5	M 3 x 10	4	2	14	4,8	103	95	0,080	37,10				
CE02- 8*	8	15	27	24	12	10,0	25,0	29,0	M 4 x 10	3	5	28	7,0	104	101	0,100	37,10				
CE02- 10*	10	16	29	26	14	8,5	26,0	30,0	M 4 x 10	4	5	46	9,0	110	108	0,120	37,10				
CE02- 12	12	18	32	28	14	8,5	26,0	30,0	M 4 x 10	4	5	55	9,0	88	96	0,140	37,10				
CE02- 14	14	23	38	33	14	8,5	26,0	30,0	M 4 x 10	4	5	64	9,0	75	75	0,150	37,10				
CE02- 15	15	24	45	40	16	12,5	36,0	42,0	M 6 x 16	4	15	150	19,0	102	132	0,209	37,10				
CE02- 16	16	24	45	40	16	12,5	36,0	42,0	M 6 x 16	4	15	150	19,0	96	132	0,218	37,10				
CE02- 18	18	26	47	43	18	13,0	38,0	44,0	M 6 x 18	4	17	200	23,0	102	129	0,226	37,10				
CE02- 19	19	27	49	44	18	13,0	38,0	44,0	M 6 x 18	4	17	210	23,0	97	125	0,248	37,10				
CE02- 20	20	28	49	44	18	13,0	38,0	44,0	M 6 x 18	4	17	220	23,0	92	120	0,248	38,30				
CE02- 22	22	32	54	49	25	13,0	45,0	51,0	M 6 x 18	4	17	250	23,0	69	76	0,325	39,40				
CE02- 24	24	34	56	51	25	13,0	45,0	51,0	M 6 x 18	4	17	270	23,0	63	71	0,344	39,40				
CE02- 25	25	34	56	51	25	13,0	45,0	51,0	M 6 x 18	4	17	280	23,0	61	71	0,332	42,20				
CE02- 28	28	39	61	56	25	13,0	45,0	51,0	M 6 x 18	6	17	500	34,0	81	93	0,410	42,20				
CE02- 30	30	41	62	57	25	13,0	45,0	51,0	M 6 x 18	6	17	520	34,0	76	89	0,414	42,20				
CE02- 32	32	43	65	59	30	13,0	50,0	56,0	M 6 x 18	8	17	730	46,0	84	94	0,478	50,40				
CE02- 35	35	47	69	64	30	13,0	50,0	56,0	M 6 x 18	8	17	800	46,0	77	86	0,546	50,40				
CE02- 38	38	50	72	67	30	13,0	50,0	56,0	M 6 x 18	8	17	900	46,0	71	81	0,580	54,60				
CE02- 40	40	53	75	70	30	13,0	50,0	56,0	M 6 x 18	8	17	900	46,0	67	76	0,626	54,60				
CE02- 42	42	55	78	73	40	17,0	65,0	73,0	M 8 x 22	8	41	1800	84,0	89	101	0,880	63,50				
CE02- 45	45	59	85	79	40	17,0	65,0	73,0	M 8 x 22	8	41	1900	84,0	84	94	1,028	67,80				
CE02- 48	48	62	87	82	45	17,0	70,0	78,0	M 8 x 22	8	41	2000	84,0	72	79	0,980	73,90				
CE02- 50	50	65	92	85	45	17,0	70,0	78,0	M 8 x 22	10	41	2600	105,0	87	95	1,270	78,20				
CE02- 55	55	71	98	92	50	17,0	75,0	83,0	M 8 x 22	10	41	2900	105,0	73	78	1,480	94,80				
CE02- 60	60	77	104	98	50	17,0	75,0	83,0	M 8 x 22	10	41	3100	105,0	67	72	1,658	106,00				
CE02- 65	65	84	111	105	50	17,0	75,0	83,0	M 8 x 22	10	41	3400	105,0	62	66	1,922	121,00				
CE02- 70	70	90	119	114	60	20,0	91,0	101,0	M10 x 25	10	83	5800	170,0	91	82	2,936	154,00				
CE02- 75	75	95	126	120	60	20,0	91,0	101,0	M10 x 25	10	83	6200	170,0	70	77	2,290	184,00				
CE02- 80	80	100	131	125	65	20,0	96,0	106,0	M10 x 25	12	83	7800	200,0	74	81	3,342	199,00				
CE02- 85	85	106	137	131	65	20,0	96,0	106,0	M10 x 25	12	83	8500	200,0	70	77	3,622	201,00				
CE02- 90	90	112	143	137	65	20,0	96,0	106,0	M10 x 25	15	83	11200	250,0	83	91	3,956	216,00				
CE02- 95*	95	120	153	146	65	20,0	96,0	106,0	M10 x 25	15	83	11800	250,0	78	85	4,460	239,00				
CE02-100*	100	125	162	155	65	24,0	102,0	114,0	M12 x 30	12	145	14600	300,0	82	95	6,000	239,00				

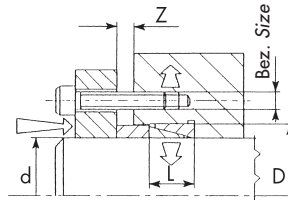

Type CE03

Bezeichnung Part No.	Abmessung Dimension							bei Anzugsmoment M_t übertragbar with tightening torque M_t applied		Flächen- pression Pressure		ges. Axialkraft der Spann- schrauben Total axial force on the tension screws	Gewicht Weight	€/Stück each
	d	D	L	Z				Drehmoment Torque	Axialkraft Axial force	Welle Shaft	Nabe Hub			
				1	2	3	4							
				(mm)	(mm)	(mm)	(mm)							
CE03- 6*	6	9	4,5	3	3	3	4	2	0,8	96	65	4	0,001	6,20
CE03- 8*	8	11	4,5	3	3	3	4	5	1,0	108	80	6	0,001	6,20
CE03- 10*	10	13	4,5	3	3	3	4	10	2,0	112	100	16	0,002	6,20
CE03- 12*	12	15	4,5	3	3	3	4	11	2,0	111	90	16	0,002	6,20
CE03- 14	14	18	6,3	3	4	4	5	22	3,0	112	90	26	0,004	6,20
CE03- 15	15	19	6,3	3	4	4	5	25	3,0	112	90	27	0,004	6,20
CE03- 16	16	20	6,3	3	4	4	5	26	3,0	112	90	27	0,005	6,20
CE03- 17	17	21	6,3	3	4	4	5	30	3,0	112	90	27	0,006	6,20
CE03- 18	18	22	6,3	3	4	4	5	33	3,0	112	90	33	0,006	6,20
CE03- 19	19	24	6,3	3	4	4	5	40	4,0	112	90	33	0,006	6,20
CE03- 20	20	25	6,3	3	4	4	5	44	4,0	112	90	33	0,008	6,20
CE03- 22	22	26	6,3	3	4	4	5	50	4,0	100	90	34	0,010	6,20
CE03- 24	24	28	6,3	3	4	4	5	68	6,0	114	100	34	0,006	6,20
CE03- 25	25	30	6,3	3	4	4	5	75	6,0	120	100	37	0,010	6,20
CE03- 28	28	32	6,3	3	4	4	5	90	6,0	111	100	40	0,008	6,50
CE03- 30	30	35	6,3	3	4	4	5	100	7,0	111	100	40	0,012	6,50
CE03- 32	32	36	6,3	3	4	4	5	120	7,0	111	100	40	0,010	6,50
CE03- 35	35	40	7,0	3	4	4	5	160	9,0	111	100	50	0,015	6,50
CE03- 38	38	44	7,0	4	5	5	6	190	10,0	111	100	60	0,020	6,50
CE03- 40	40	45	8,0	4	5	5	6	230	11,0	111	100	70	0,020	6,50
CE03- 42	42	48	8,0	4	5	5	6	260	12,0	111	100	70	0,025	9,70
CE03- 45	45	52	10,0	4	5	5	6	390	17,0	111	100	110	0,039	9,70
CE03- 48	48	55	10,0	4	5	5	6	430	18,0	111	100	110	0,042	9,70
CE03- 50	50	57	10,0	4	5	5	6	470	19,0	111	100	110	0,044	9,70
CE03- 55	55	62	10,0	4	5	5	6	580	21,0	111	100	120	0,048	11,60
CE03- 60	60	68	12,0	4	5	6	7	840	28,0	111	100	160	0,072	11,60
CE03- 65	65	73	12,0	4	5	6	7	1000	30,0	111	100	160	0,078	13,30
CE03- 70	70	79	14,0	4	5	6	7	1300	38,0	111	100	200	0,112	16,30
CE03- 75	75	84	14,0	4	5	6	7	1500	41,0	111	100	220	0,120	19,10
CE03- 80	80	91	17,0	5	6	7	8	2100	54,0	111	100	300	0,190	22,00
CE03- 85*	85	96	17,0	5	6	7	8	2300	56,0	111	100	310	0,200	29,40
CE03- 90	90	101	17,0	5	6	7	8	2700	61,0	111	100	320	0,212	29,40
CE03- 95*	95	106	17,0	5	6	7	8	3500	73,0	111	100	380	0,230	35,20
CE03-100	100	114	21,0	5	6	8	9	4200	84,0	111	100	440	0,376	35,20
CE03-110*	110	124	21,0	5	6	8	9	4300	86,0	111	90	450	0,410	37,80
CE03-120*	120	134	21,0	5	6	8	9	5100	88,0	111	90	460	0,450	41,60
CE03-130*	130	148	28,0	6	7	9	11	8100	125,0	111	90	650	0,828	56,10
CE03-140*	140	158	28,0	6	7	9	11	9400	135,0	111	90	690	0,898	65,10
CE03-150*	150	168	28,0	6	7	9	11	11000	145,0	111	90	720	0,973	69,00

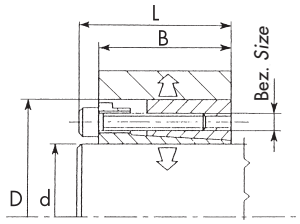

Type CE04

Bezeichnung Part No.	Abmessung Dimension				Schrauben Screws			bei Anzugsmoment M_s übertragbar with tightening torque M_s applied		Flächen- pressung Pressure		Gewicht Weight	
								Drehmoment Torque	Axialkraft Axial force	Welle Shaft	Nabe Hub		
	d	D	B	L	Bezeichnung Part No.	Anzahl No.	Anzugs- moment Tightening torque M_s	M	F	P_w	P_N		
	(mm)	(mm)	(mm)	(mm)		Stück each	(N _m)	(N _m)	(K _N)	(N/ mm ²)	(N/ mm ²)		
CE04- 20	20	47	42	48	M 6 x 25	6	17	530	52	190	110	0,384	29,50
CE04- 22	22	47	42	48	M 6 x 25	6	17	580	52	170	110	0,366	29,50
CE04- 24	24	50	42	48	M 6 x 25	6	17	630	52	160	100	0,410	32,50
CE04- 25	25	50	42	48	M 6 x 25	6	17	660	52	150	100	0,402	32,50
CE04- 28	28	55	42	48	M 6 x 25	6	17	740	52	130	100	0,482	32,50
CE04- 30	30	55	42	48	M 6 x 25	6	17	790	52	130	100	0,458	32,50
CE04- 32	32	60	42	48	M 6 x 25	8	17	1180	70	160	120	0,520	34,50
CE04- 35	35	60	42	48	M 6 x 25	8	17	1230	70	140	120	0,510	34,50
CE04- 38	38	65	42	48	M 6 x 25	8	17	1300	70	130	110	0,600	35,50
CE04- 40	40	65	42	48	M 6 x 25	8	17	1400	70	125	110	0,568	35,50
CE04- 42	42	75	50	58	M 8 x 30	6	41	2000	100	130	120	1,020	43,90
CE04- 45	45	75	50	58	M 8 x 30	6	41	2200	100	125	120	0,934	43,90
CE04- 48	48	80	50	58	M 8 x 30	8	41	3200	130	155	150	1,050	45,60
CE04- 50	50	80	50	58	M 8 x 30	8	41	3300	130	150	150	1,008	45,60
CE04- 55	55	85	50	58	M 8 x 30	8	41	3600	130	135	140	1,124	50,80
CE04- 60	60	90	50	58	M 8 x 30	8	41	3900	130	125	130	1,210	54,00
CE04- 65	65	95	50	58	M 8 x 30	8	41	4200	130	115	120	1,234	93,50
CE04- 70	70	110	60	70	M10 x 30	8	83	7500	210	150	130	2,306	102,00
CE04- 75*	75	115	60	70	M10 x 30	8	83	8000	210	140	130	2,466	105,00
CE04- 80	80	120	60	70	M10 x 30	8	83	8500	210	130	120	2,588	106,00
CE04- 85*	85	125	60	70	M10 x 30	10	83	11400	270	155	150	2,700	119,00
CE04- 90	90	130	60	70	M10 x 30	10	83	12000	270	145	140	2,832	122,00
CE04-100	100	145	68	80	M12 x 35	8	145	15000	300	130	120	3,936	157,00
CE04-110*	110	155	68	80	M12 x 35	8	145	16500	300	120	110	4,300	233,00
CE04-120*	120	165	68	80	M12 x 35	10	145	22500	370	135	130	4,600	258,00
CE04-130*	130	180	68	80	M12 x 35	12	145	29300	450	150	140	5,500	290,00
CE04-140*	140	190	76	90	M14 x 40	10	210	32200	460	130	125	6,700	292,00
CE04-150*	150	200	76	90	M14 x 40	12	210	41400	550	145	140	7,000	295,00
CE04-160*	160	210	76	90	M14 x 40	12	210	44100	550	135	130	7,500	304,00
CE04-170*	170	225	76	90	M14 x 40	14	210	54700	640	150	150	8,700	369,00
CE04-180*	180	235	76	90	M14 x 40	14	210	57900	640	140	140	9,200	387,00

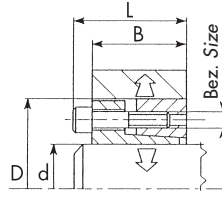

Type CE05

Bezeichnung Part No.	Abmessung Dimension				Schrauben Screws			bei Anzugsmoment M _s übertragbar with tightening torque M _s applied		Flächen- pression Pressure		Gewicht Weight	€/Stück each
	d	D	B	L	Bezeichnung Part No.	Anzahl No.	Anzugs- moment Tightening torque M _s	Drehmoment Torque	Axialkraft Axial force	Welle Shaft	Nabe Hub		
								M	F	P _w	P _N		
	(mm)	(mm)	(mm)	(mm)	Stück each	(N _m)	(N _m)	(K _N)	(N/ mm ²)	(N/ mm ²)	(kg)		
CE05- 20	20	47	28	34	M 6 x 20	6	14	410	41	218	137	0,260	25,40
CE05- 22	22	47	28	34	M 6 x 20	6	14	450	41	198	137	0,250	25,40
CE05- 24*	24	50	28	34	M 6 x 20	6	14	490	41	182	128	0,276	27,90
CE05- 25	25	50	28	34	M 6 x 20	6	14	510	41	175	128	0,268	27,90
CE05- 28*	28	55	28	34	M 6 x 20	6	14	570	41	156	117	0,322	27,90
CE05- 30	30	55	28	34	M 6 x 20	6	14	610	41	145	117	0,304	29,10
CE05- 32*	32	60	28	34	M 6 x 20	8	14	880	54	182	143	0,370	32,30
CE05- 35	35	60	28	34	M 6 x 20	8	14	960	54	166	143	0,344	32,30
CE05- 38*	38	65	28	34	M 6 x 20	8	14	1040	54	153	132	0,408	34,10
CE05- 40	40	65	28	34	M 6 x 20	8	14	1090	54	145	132	0,378	34,10
CE05- 42*	42	75	33	41	M 8 x 25	8	35	2200	105	201	186	0,630	39,50
CE05- 45	45	75	33	41	M 8 x 25	8	35	2360	105	207	186	0,630	39,50
CE05- 48*	48	80	33	41	M 8 x 25	8	35	2520	105	194	174	0,680	42,10
CE05- 50	50	80	33	41	M 8 x 25	8	35	2620	105	186	174	0,686	42,10
CE05- 55*	55	85	33	41	M 8 x 25	8	35	2890	105	169	164	0,720	49,10
CE05- 60	60	90	33	41	M 8 x 25	8	35	3150	105	155	155	0,794	49,10
CE05- 65*	65	95	33	41	M 8 x 25	8	35	3410	105	143	174	0,842	61,60
CE05- 70*	70	110	40	50	M10 x 30	8	70	5990	170	180	172	1,534	94,60
CE05- 75*	75	115	40	50	M10 x 30	8	70	6420	170	168	165	1,634	104,00
CE05- 80*	80	120	40	50	M10 x 30	8	70	6850	170	158	158	1,722	104,00
CE05- 85*	95	125	40	50	M10 x 30	10	70	9090	210	186	189	1,834	116,00
CE05- 90*	90	130	40	50	M10 x 30	10	70	9630	210	175	182	1,900	120,00
CE05-100*	100	145	44	56	M12 x 30	8	115	11900	240	158	168	2,618	153,00
CE05-110*	110	155	44	56	M12 x 30	8	115	13090	240	144	157	2,788	162,00
CE05-120*	120	165	44	56	M12 x 30	9	115	16060	270	148	166	3,600	164,00
CE05-130*	130	180	52	64	M12 x 30	12	115	23200	360	152	155	4,410	224,00
CE05-140*	140	190	54	68	M14 x 40	9	185	25500	360	138	150	4,920	233,00
CE05-150*	150	200	54	68	M14 x 40	10	185	30300	400	143	158	5,200	274,00
CE05-160*	160	210	54	68	M14 x 40	12	185	38800	490	161	181	5,600	285,00
CE05-180*	180	235	64	78	M14 x 40	12	185	43700	490	119	125	8,500	356,00
CE05-200*	200	260	64	78	M14 x 40	15	185	60700	610	134	141	9,600	463,00

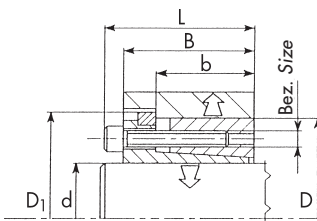

Type CE06

Bezeichnung Part No.	Abmessung Dimension						Schrauben Screws			bei Anzugsmoment M_s übertragbar with tightening torque M_s applied		Flächen- pression Pressure		Gewicht Weight	€/Stück each
	d	D	D ₁	b	B	L	Bezeichnung Part No.	Anzahl No.	Anzugs- moment tightening torque M_s	Drehmoment	Axialkraft	Welle	Nabe		
										Torque	Axial force	Shaft	Hub		
										M	F	P _w	P _N		
(mm)	(mm)	(mm)	(mm)	(mm)	(mm)		Stück each	(N _m)	(K _N)	(N/ mm ²)	(N/ mm ²)	(kg)			
CE06- 20	20	47	53	31,0	42	48	M 6 x 25	6	17	320	33	116	70	0,416	32,90
CE06- 22	22	47	53	31,0	42	48	M 6 x 25	6	17	360	33	105	70	0,398	32,90
CE06- 24	24	50	56	31,0	42	48	M 6 x 25	6	17	390	33	97	70	0,442	36,10
CE06- 25	25	50	56	31,0	42	48	M 6 x 25	6	17	400	33	93	70	0,434	36,10
CE06- 28	28	55	61	31,0	42	48	M 6 x 25	6	17	450	33	83	60	0,516	36,10
CE06- 30	30	55	61	31,0	42	48	M 6 x 25	6	17	490	33	77	60	0,492	36,10
CE06- 32	32	60	66	31,0	42	48	M 6 x 25	8	17	690	43	97	70	0,560	39,10
CE06- 35	35	60	66	31,0	42	48	M 6 x 25	8	17	750	43	88	70	0,548	39,10
CE06- 38	38	65	71	31,0	42	48	M 6 x 25	8	17	820	43	81	70	0,650	40,20
CE06- 40	40	65	71	31,0	42	48	M 6 x 25	8	17	860	43	77	70	0,608	40,20
CE06- 42	42	75	81	36,0	50	58	M 8 x 30	6	41	1250	60	82	70	1,090	48,50
CE06- 45	45	75	81	36,0	50	58	M 8 x 30	6	41	1340	60	77	70	1,004	48,50
CE06- 48	48	80	86	36,0	50	58	M 8 x 30	8	41	1910	80	96	90	1,100	50,30
CE06- 50	50	80	86	36,0	50	58	M 8 x 30	8	41	1990	80	92	90	1,074	50,30
CE06- 55	55	85	91	36,0	50	58	M 8 x 30	8	41	2200	80	84	90	1,204	56,50
CE06- 60	60	90	96	36,0	50	58	M 8 x 30	8	41	2400	80	77	80	1,292	62,50
CE06- 65	65	95	101	36,0	50	58	M 8 x 30	8	41	2600	80	71	70	1,308	103,00
CE06- 70	70	110	119	46,0	60	70	M10 x 30	8	83	4600	130	92	80	2,440	110,00
CE06- 75*	75	115	124	46,0	60	70	M10 x 30	8	83	4930	130	86	80	2,596	114,00
CE06- 80	80	120	129	46,0	60	70	M10 x 30	8	83	5200	130	81	70	2,730	116,00
CE06- 85*	85	125	134	46,0	60	70	M10 x 30	10	83	7000	165	95	90	2,800	128,00
CE06- 90	90	130	139	46,0	60	70	M10 x 30	10	83	7400	165	90	80	2,986	132,00
CE06-100	100	145	155	52,0	68	80	M12 x 35	8	145	9700	190	84	80	4,136	171,00
CE06-110*	110	155	165	52,0	68	80	M12 x 35	8	145	10680	190	77	70	4,500	251,00
CE06-120*	120	165	175	52,0	68	80	M12 x 35	10	145	14500	240	88	90	4,800	284,00
CE06-130*	130	180	188	52,0	68	80	M12 x 35	12	145	18900	290	97	100	5,800	319,00
CE06-140*	140	190	199	58,5	76	90	M14 x 40	10	230	22800	325	91	90	7,000	321,00
CE06-150*	150	200	209	58,5	76	90	M14 x 40	12	230	29300	390	102	100	7,300	328,00
CE06-160*	160	210	219	58,5	76	90	M14 x 40	12	230	31300	390	95	100	7,800	345,00
CE06-170*	170	225	234	58,5	76	90	M14 x 40	14	230	38800	460	105	110	9,600	411,00
CE06-180*	180	235	244	58,5	76	90	M14 x 40	14	230	41000	460	99	100	9,000	416,00

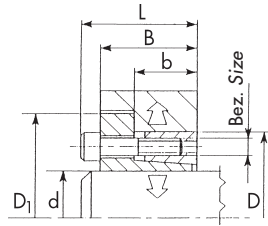

Type CE07

Bezeichnung Part No.	Abmessung Dimension						Schrauben Screws			bei Anzugsmoment M _s übertragbar with tightening torque M _s applied		Flächen- pression Pressure		Gewicht Weight	
										Drehmoment Torque	Axialkraft Axial force	Welle Shaft	Nabe Hub		
	d	D	D ₁	b	B	L	Bezeichnung Part No.	Anzahl No.	Anzugs- moment tightening torque M _s	M	F	P _w	P _N		
	(mm)	(mm)	(mm)	(mm)	(mm)	(mm)		Stück each	(N _m)	(N _m)	(K _N)	(N/ mm ²)	(N/ mm ²)		
CE07- 20	20	47	56	22	28	34	M 6 x 20	6	17	320	32	171	100	0,280	25,40
CE07- 22	22	47	56	22	28	34	M 6 x 20	6	17	350	32	156	100	0,270	25,40
CE07- 24	24	50	59	22	28	34	M 6 x 20	6	17	390	32	143	100	0,310	27,90
CE07- 25	25	50	59	22	28	34	M 6 x 20	6	17	400	32	137	100	0,304	27,90
CE07- 28	28	55	64	22	28	34	M 6 x 20	6	17	450	32	122	90	0,362	27,90
CE07- 30	30	55	64	22	28	34	M 6 x 20	6	17	490	32	114	90	0,346	29,10
CE07- 32	32	60	69	22	28	34	M 6 x 20	8	17	700	43	143	110	0,420	32,30
CE07- 35	35	60	69	22	28	34	M 6 x 20	8	17	760	43	131	110	0,390	32,30
CE07- 38	38	65	74	22	28	34	M 6 x 20	8	17	820	43	120	100	0,454	34,10
CE07- 40	40	65	74	22	28	34	M 6 x 20	8	17	870	43	114	100	0,446	34,10
CE07- 42	42	75	84	25	33	41	M 8 x 25	6	41	1700	80	168	140	0,440	39,50
CE07- 45	45	75	84	25	33	41	M 8 x 25	6	41	1800	80	157	140	0,696	39,50
CE07- 48	48	80	89	25	33	41	M 8 x 25	8	41	1900	80	147	130	0,800	42,10
CE07- 50	50	80	89	25	33	41	M 8 x 25	8	41	2000	80	141	130	0,756	42,10
CE07- 55	55	85	91	25	33	41	M 8 x 25	8	41	2200	80	128	120	0,850	49,10
CE07- 60	60	90	99	25	33	41	M 8 x 25	8	41	2400	80	117	120	0,900	49,10
CE07- 65	65	95	104	25	33	41	M 8 x 25	8	41	2600	80	108	110	0,934	61,60
CE07- 70	70	110	119	30	40	50	M10 x 30	8	83	4600	130	138	130	1,670	94,60
CE07- 75	75	115	124	30	40	50	M10 x 30	8	83	5000	130	129	130	1,760	104,00
CE07- 80	80	120	129	30	40	50	M10 x 30	8	83	5300	130	121	120	1,868	104,00
CE07- 85	85	125	134	30	40	50	M10 x 30	10	83	7000	160	142	150	1,966	116,00
CE07- 90	90	130	139	30	40	50	M10 x 30	10	83	7400	160	135	140	2,046	120,00
CE07-100	100	145	154	32	44	56	M12 x 30	8	145	9700	200	129	140	2,830	153,00
CE07-110	110	155	164	32	44	56	M12 x 30	8	145	10700	200	117	130	3,100	162,00
CE07-120	120	165	174	32	44	56	M12 x 30	9	145	13100	220	121	140	3,284	164,00
CE07-130	130	180	189	40	52	64	M12 x 30	12	145	19000	290	124	130	4,600	224,00
CE07-140*	140	190	199	40	54	68	M14 x 40	9	230	20500	300	111	120	4,980	233,00
CE07-150*	150	200	209	40	54	68	M14 x 40	10	230	24500	330	115	130	5,200	274,00
CE07-160*	160	210	219	40	54	68	M14 x 40	12	230	31300	390	130	150	5,600	285,00
CE07-180*	180	235	244	50	64	78	M14 x 40	12	230	35000	390	96	100	8,500	356,00
CE07-200*	200	260	269	50	64	78	M14 x 40	15	230	49000	500	108	110	9,600	463,00

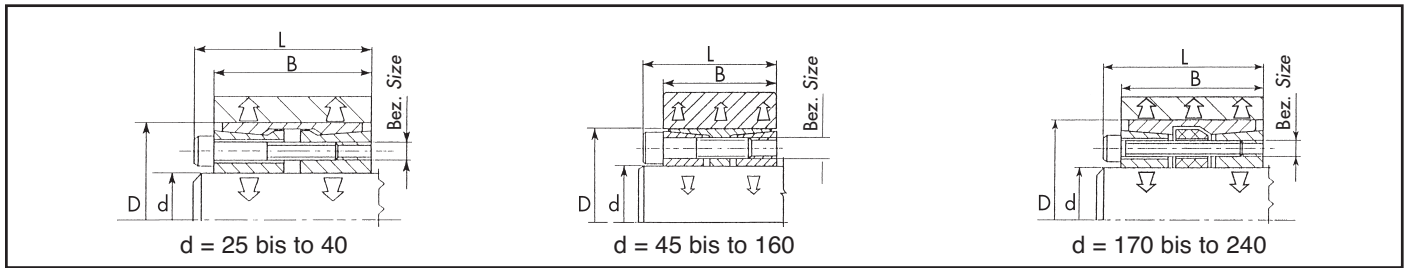

Type CE08

Bezeichnung Part No.	Abmessung Dimension				Schrauben Screws			bei Anzugsmoment M_s übertragbar with tightening torque M_s applied		Flächen- pression Pressure		Gewicht Weight	
								Drehmoment Torque	Axialkraft Axial force	Welle Shaft	Nabe Hub		
	d	D	B	L	Bezeichnung Part No.	Anzahl No.	Anzugs- moment Tightening torque M_s	M	F	P_w	P_N		
	(mm)	(mm)	(mm)	(mm)		Stück each	(N _m)	(N _m)	(K _N)	(N/ mm ²)	(N/ mm ²)		
CE08- 25*	25	50	45	51	M 6 x 35	6	17	700	55	157	80	0,415	67,60
CE08- 30*	30	55	45	51	M 6 x 35	8	17	1200	70	175	90	0,464	70,30
CE08- 35*	35	60	45	51	M 6 x 35	8	17	1400	70	150	90	0,526	78,00
CE08- 40*	40	65	45	51	M 6 x 35	10	17	2000	90	164	100	0,550	94,00
CE08- 45	45	75	45	53	M 8 x 35	8	41	3200	140	216	130	0,768	109,00
CE08- 50	50	80	64	72	M 8 x 55	8	41	3600	140	165	80	1,326	125,00
CE08- 55*	55	85	64	72	M 8 x 55	8	41	4000	140	150	80	1,430	137,00
CE08- 60	60	90	64	72	M 8 x 55	10	41	5400	170	171	90	1,524	140,00
CE08- 65*	65	95	64	72	M 8 x 55	10	41	5800	170	158	90	2,000	172,00
CE08- 70	70	110	78	88	M10 x 60	10	83	10300	280	199	100	2,932	202,00
CE08- 75*	75	115	78	88	M10 x 60	10	83	11000	280	186	100	3,100	225,00
CE08- 80	80	120	78	88	M10 x 60	12	83	14000	340	209	110	3,300	232,00
CE08- 85*	85	125	78	88	M10 x 60	12	83	15000	340	197	110	3,400	246,00
CE08- 90	90	130	78	88	M10 x 60	12	83	16000	340	186	100	3,600	250,00
CE08- 95*	95	135	78	88	M10 x 60	12	83	17000	340	176	100	4,000	306,00
CE08-100	100	145	100	112	M12 x 80	12	145	26000	500	198	100	6,000	325,00
CE08-110*	110	155	100	112	M12 x 80	12	145	29000	500	180	100	6,000	367,00
CE08-120*	120	165	100	112	M12 x 80	14	145	36400	600	192	110	6,000	395,00
CE08-130*	130	180	116	130	M14 x 90	12	230	45400	700	174	100	10,100	545,00
CE08-140*	140	190	116	130	M14 x 90	14	230	57000	800	189	110	10,500	670,00
CE08-150*	150	200	116	130	M14 x 90	16	230	70000	900	201	120	11,000	712,00
CE08-160*	160	210	116	130	M14 x 90	16	230	75000	900	189	110	12,000	753,00
CE08-170*	170	225	146	162	M16 x 110	14	355	95000	1100	168	100	17,000	865,00
CE08-180*	180	235	146	162	M16 x 110	15	355	115000	1200	182	110	18,400	920,00
CE08-190*	190	250	146	162	M16 x 110	16	355	121500	1200	172	100	21,400	1.073,00
CE08-200*	200	260	146	162	M16 x 110	16	355	128000	1200	163	100	21,800	1.144,00

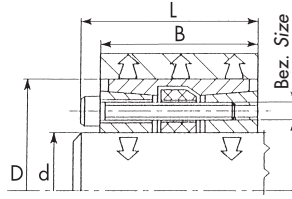

Type CE09

Bezeichnung Part No.	Abmessung Dimension				Schrauben Screws			bei Anzugsmoment M_s übertragbar with tightening torque M_s applied		Flächen- pressung Pressure		Gewicht Weight	
								Drehmoment Torque	Axialkraft Axial force	Welle Shaft	Nabe Hub		
	d	D	B	L	Bezeichnung Part No.	Anzahl No.	Anzugs- moment Tightening torque M_s	M	F	P_W	P_N		
	(mm)	(mm)	(mm)	(mm)		Stück each	(N _m)	(N _m)	(K _N)	(N/ mm ²)	(N/ mm ²)		
CE09- 45*	45	75	64	72	M 8 x 55	8	41	3200	120	210	125	1,000	164,00
CE09- 50*	50	80	78	86	M 8 x 65	8	41	3550	120	140	65	1,500	178,00
CE09- 60	60	90	78	86	M 8 x 65	10	41	5330	150	146	75	2,000	201,00
CE09- 70	70	110	102	112	M10 x 90	10	83	10260	250	147	75	4,000	303,00
CE09- 80*	80	120	102	112	M10 x 90	12	83	14000	300	154	85	5,000	341,00
CE09- 90*	90	130	102	112	M10 x 90	12	83	15800	300	137	75	6,000	354,00
CE09-100*	100	145	122	134	M12 x 110	12	145	26000	450	149	85	7,000	460,00

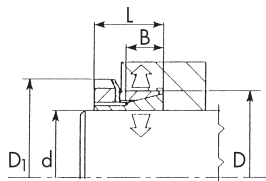

Type CE10

Bezeichnung Part No.	Abmessung Dimension					Schrauben Screws			bei Anzugsmoment M_s übertragbar with tightening torque M_s applied		Flächen- pression Pressure		Gewicht Weight	
	d	D	D ₁	B	L	Bezeichnung Part No.	Anzahl No.	Anzugs- moment Tightening torque M_s	Drehmoment Torque	Axialkraft Axial force	Welle Shaft	Nabe Hub		
									M	F	P _W	P _N		
									(N _m)	(K _N)	(N/ mm ²)	(N/ mm ²)		
(mm)	(mm)	(mm)	(mm)	(mm)		Stück each	(N _m)	(K _N)	(N/ mm ²)	(N/ mm ²)	(kg)	€/Stück each		
CE10-14	14	25	32	6,5	16,5	M20 x 1,5	1	65	37	6	171	73	0,052	14,30
CE10-15	15	25	32	6,5	16,5	M20 x 1,5	1	65	40	6	159	73	0,050	14,30
CE10-16	16	25	32	6,5	16,5	M20 x 1,5	1	65	42	6	149	73	0,048	15,80
CE10-18	18	30	38	7,0	17,0	M25 x 1,5	1	85	65	8	168	80	0,080	15,80
CE10-19	19	30	38	7,0	17,0	M25 x 1,5	1	95	60	7	136	70	0,078	17,10
CE10-20	20	30	38	7,0	17,0	M25 x 1,5	1	110	70	8	149	80	0,074	17,10
CE10-24	24	35	45	7,0	17,0	M30 x 1,5	1	155	100	10	147	80	0,100	18,00
CE10-25	25	35	45	7,0	17,0	M30 x 1,5	1	160	110	10	146	90	0,092	18,00
CE10-28	28	40	52	8,0	20,0	M35 x 1,5	1	200	140	11	126	70	0,140	19,60
CE10-30	30	40	52	8,0	20,0	M35 x 1,5	1	240	170	14	138	80	0,130	21,40
CE10-32	32	45	58	9,0	22,0	M40 x 1,5	1	320	210	15	135	80	0,170	21,70
CE10-35	35	45	58	9,0	22,0	M40 x 1,5	1	320	230	15	123	80	0,168	21,70
CE10-40	40	50	64	9,0	23,0	M45 x 1,5	1	440	330	19	132	90	0,216	21,70
CE10-45	45	55	70	10,0	25,5	M50 x 1,5	1	550	440	23	127	90	0,266	23,20
CE10-50*	50	60	75	10,0	25,5	M55 x 1,5	1	660	530	25	125	90	0,278	28,90
CE10-60*	60	70	85	12,0	29,5	M65 x 1,5	1	900	830	32	112	80	0,390	28,90

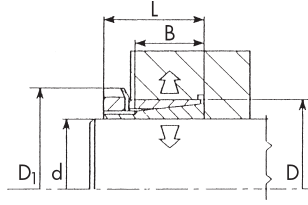

Type CE11

Bezeichnung Part No.	Abmessung Dimension					Schrauben Screws			bei Anzugsmoment M_s übertragbar with tightening torque M_s applied		Flächen- pression Pressure		Gewicht Weight	
	d	D	D ₁	B	L	Bezeichnung Part No.	Anzahl No.	Anzugs- moment Tightening torque M_s	Drehmoment Torque	Axialkraft Axial force	Welle Shaft	Nabe Hub		
									M	F	P _W	P _N		
									(N _m)	(K _N)	(N/ mm ²)	(N/ mm ²)		
(mm)	(mm)	(mm)	(mm)	(mm)		Stück each	(N _m)	(K _N)	(N/ mm ²)	(N/ mm ²)	(kg)	€/Stück each		
CE11-14	14	25	32	17	29	M20 x 1,5	1	90	90	15	145	80	0,080	21,60
CE11-15	15	25	32	17	29	M20 x 1,5	1	90	100	15	136	80	0,074	21,60
CE11-16	16	25	32	17	29	M20 x 1,5	1	70	80	12	99	60	0,072	21,60
CE11-18	18	30	38	18	31	M25 x 1,5	1	190	200	25	179	110	0,120	22,80
CE11-19	19	30	38	18	31	M25 x 1,5	1	150	170	20	134	90	0,114	22,80
CE11-20	20	30	38	18	31	M25 x 1,5	1	110	130	15	93	60	0,104	22,80
CE11-24	24	35	45	22	35	M30 x 1,5	1	230	270	26	112	80	0,162	24,70
CE11-25	25	35	45	22	35	M30 x 1,5	1	170	200	19	80	60	0,150	24,70
CE11-28	28	40	52	22	35	M35 x 1,5	1	390	460	38	141	110	0,214	24,70
CE11-30	30	40	52	22	35	M35 x 1,5	1	240	300	24	63	70	0,192	24,70
CE11-32	32	45	58	27	42	M40 x 1,5	1	320	420	31	80	70	0,280	28,90
CE11-35	35	45	58	28	42	M40 x 1,5	1	320	460	31	70	60	0,270	28,90
CE11-40	40	50	64	28	44	M45 x 1,5	1	440	640	37	75	70	0,330	28,90
CE11-45	45	55	70	28	45	M50 x 1,5	1	550	760	40	71	60	0,386	35,60
CE11-50	50	60	75	28	46	M50 x 1,5	1	660	930	44	70	60	0,408	39,30
CE11-60	60	70	85	28	52	M65 x 1,5	1	1050	1500	59	79	70	0,550	47,10

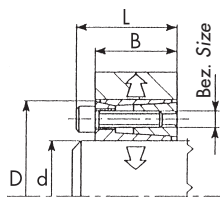

Type CE12

Bezeichnung Part No.	Abmessung Dimension				Schrauben Screws			bei Anzugsmoment M_s übertragbar with tightening torque M_s applied		Flächen- pression Pressure		Gewicht Weight	
	d	D	B	L	Bezeichnung Part No.	Anzahl No.	Anzugs- moment Tightening torque M_s	Drehmoment Torque	Axialkraft Axial force	Welle Shaft	Nabe Hub		
								M	F	P_W	P_N		
								(mm)	(mm)	(mm)	(mm)		
CE12-16*	16	32	17,0	21,0	M4 x 14	4	5	80	13	134	68	0,070	32,00
CE12-18*	18	40	18,0	24,0	M6 x 15	4	17	180	24	119	100	0,122	36,60
CE12-19*	19	41	18,0	24,0	M6 x 15	4	17	190	24	215	100	0,126	36,60
CE12-20*	20	42	18,0	24,0	M6 x 15	4	17	200	24	204	100	0,130	36,60
CE12-22*	22	44	18,0	24,0	M6 x 15	4	17	220	24	186	90	0,138	36,60
CE12-24*	24	46	18,0	24,0	M6 x 15	6	17	360	36	170	130	0,150	39,30
CE12-25*	25	47	18,0	24,0	M6 x 15	6	17	380	36	245	130	0,160	39,30
CE12-28*	28	50	18,0	24,0	M6 x 15	6	17	420	36	219	120	0,165	41,20
CE12-30*	30	52	18,0	24,0	M6 x 15	6	17	450	36	204	120	0,174	41,20
CE12-32*	32	54	18,0	24,0	M6 x 15	6	17	480	36	191	110	0,184	45,70
CE12-35*	35	57	21,5	27,5	M6 x 15	6	17	520	36	139	90	0,242	45,70
CE12-40*	40	62	21,5	27,5	M6 x 15	8	17	600	36	122	80	0,272	48,90
CE12-45*	45	73	28,0	36,0	M8 x 22	8	41	1700	90	84	130	0,514	58,10
CE12-50*	50	78	28,0	36,0	M8 x 22	8	41	1840	90	187	120	0,570	58,10
CE12-60*	60	88	28,0	36,0	M8 x 22	8	41	2200	90	156	100	0,644	95,60

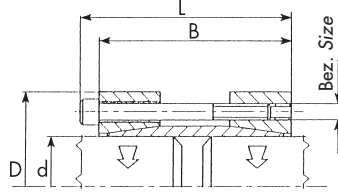

Type CE13

Bezeichnung Part No.	Abmessung Dimension				Schrauben Screws			bei Anzugsmoment M_s übertragbar with tightening torque M_s applied		Flächen- pression Pressure		Gewicht Weight	
								Drehmoment Torque	Axialkraft Axial force	Welle Shaft	Nabe Hub		
	d	D	B	L	Bezeichnung Part No.	Anzahl No.	Anzugs- moment Tightening torque M_s	M	F	P_W	P_N		
	(mm)	(mm)	(mm)	(mm)		Stück each	(N _m)	(N _m)	(K _N)	(N/ mm ²)	(N/ mm ²)		
CE13-15*	15	45	50	56	M 6 x 45	4	17	150	18	81		0,378	40,30
CE13-16*	16	45	50	56	M 6 x 45	4	17	160	18	76		0,370	40,30
CE13-18*	18	50	50	56	M 6 x 45	4	17	180	18	68		0,450	40,30
CE13-19*	19	50	50	56	M 6 x 45	4	17	190	18	64		0,444	40,30
CE13-20*	20	50	50	56	M 6 x 45	4	17	200	18	61		0,436	40,30
CE13-24*	24	55	60	66	M 6 x 55	6	17	360	27	63		0,632	41,60
CE13-25*	25	55	60	66	M 6 x 55	6	17	380	27	60		0,616	47,90
CE13-28*	28	60	60	66	M 6 x 55	6	17	370	24	46		0,752	50,90
CE13-30*	30	60	60	66	M 6 x 55	6	17	400	24	43		0,712	50,90
CE13-35*	35	75	75	83	M 8 x 70	4	41	640	32	41		1,328	67,10
CE13-40*	40	75	75	83	M 8 x 70	4	41	730	32	36		1,188	70,90
CE13-45*	45	85	85	93	M 8 x 80	6	41	1200	48	41		1,716	74,50
CE13-50*	50	90	85	93	M 8 x 80	6	41	1340	48	37		1,884	76,90
CE13-60*	60	100	85	93	M 8 x 80	8	41	2200	64	41		2,174	108,00
CE13-70*	70	115	100	110	M10 x 80	6	83	3200	80	38		4,000	168,00

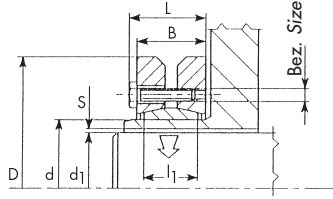

Type CE14

Bezeichnung Part No.	Abmessung Dimension							Schrauben Screws			bei Anzugsmoment M _s übertragbar with tightening torque M _s applied		Flächen- pression Pressure		Gewicht Weight	€/Stück each
	d	d ₁	D	B	L	l ₁	S	Bez. Size	Anzahl No.	Anzugs- moment Tightening torque M _s	Drehmoment Torque	Axialkraft Axial force	Welle Shaft	Nabe Hub		
											M	F	P _w	P _N		
											(N _m)	(K _N)	(N/ mm ²)	(N/ mm ²)		
(mm)	(mm)	(mm)	(mm)	(mm)	(mm)	(mm)		Stück each	(N _m)	(K _N)	(N/ mm ²)	(N/ mm ²)	(kg)			
CE14- 24*	24	19	50	19	23,0	14	0,017	M5	6	4	180	26	140	280	0,184	65,90
		20									27	170	280			
		21									29	200	280			
CE14- 30*	30	24	60	21	25,0	16	0,017	M5	6	4	310	26	200	300	0,288	67,80
		25									27	205	300			
		26									28	220	300			
CE14- 36*	36	28	72	23	27,0	18	0,017	M6	6	12	460	50	235	360	0,468	73,30
		30									54	240	360			
		31									58	260	360			
CE14- 44*	44	32	80	25	29,0	20	0,032	M6	8	12	630	65	225	350	0,590	78,90
		35									74	240	350			
		36									77	255	350			
CE14- 50*	50	38	90	27	31,0	22	0,032	M6	8	12	940	79	180	285	0,794	84,00
		40									85	200	285			
		42									90	220	285			
CE14- 55*	55	42	100	30	34,0	23	0,032	M6	8	12	1200	80	155	250	1,104	91,10
		45									90	180	250			
		48									100	200	250			
CE14- 62*	62	48	110	30	34,0	23	0,032	M6	10	12	1800	100	190	270	1,312	98,20
		50									110	195	270			
		52									120	210	270			
CE14- 68*	68	50	115	30	34,0	23	0,038	M6	10	12	2000	100	140	250	1,304	104,00
		55									110	175	250			
		60									120	210	250			
CE14- 75*	75	55	138	33	38,0	25	0,048	M8	8	30	2500	120	190	300	1,700	107,00
		60									140	220	300			
		65									150	250	300			
CE14- 80*	80	60	145	32	38,0	25	0,048	M8	8	30	3200	120	185	280	2,540	122,00
		65									140	210	280			
		70									160	240	280			
CE14- 90*	90	65	155	39	45,0	30	0,048	M8	10	30	4700	170	180	260	3,300	185,00
		70									190	200	260			
		75									210	220	260			
CE14-100*	100	70	170	44	49,5	34	0,048	M8	12	30	6900	180	165	250	4,410	213,00
		75									220	185	250			
		80									240	190	250			
CE14-110*	110	75	185	50	57,0	39	0,048	M10	10	59	7200	230	160	260	5,900	323,00
		80									250	170	260			
		85									260	185	260			
CE14-115*	115	80	188	50	57,0	39	0,048	M10	10	59	8500	210	150	245	9,000	328,00
		85									240	170	245			
		90									270	180	245			
CE14-125*	125	85	215	54	61,0	42	0,056	M10	12	59	11000	300	160	260	8,600	331,00
		90									320	180	260			
		95									350	190	260			
CE14-130*	130	90	215	52	59,0	42	0,056	M10	12	59	13700	300	160	250	8,700	408,00
		95									330	180	250			
		100									360	190	250			

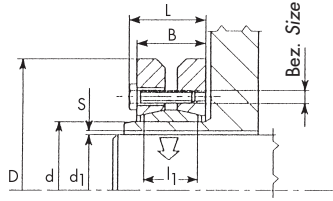

Type CE14

Bezeichnung Part No.	Abmessung Dimension							Schrauben Screws			bei Anzugsmoment M _s übertragbar with tightening torque M _s applied		Flächen- pressung Pressure		Gewicht Weight (kg)	€/Stück each
	d	d ₁	D	B	L	l ₁	S	Bez. Size	Anzahl No.	Anzugs- moment Tightening torque M _s	Drehmoment Torque	Axialkraft Axial force	Welle Shaft	Nabe Hub		
											M	F	P _w	P _N		
											(N _m)	(K _N)	(N/ mm ²)	(N/ mm ²)		
(mm)	(mm)	(mm)	(mm)	(mm)	(mm)	(mm)	Stück each	(N _m)	(K _N)	(N/ mm ²)	(N/ mm ²)	(kg)				
CE14-140*	140	95	230	60	68,0	46	0,056	M12	10	100	15000	360	170	260	10,000	524,00
		100									400	185	260			
		105									420	195	260			
CE14-155*	155	105	263	62	70,0	50	0,069	M12	12	100	20000	390	180	255	11,500	668,00
		110									420	190	255			
		115									450	200	255			
CE14-165*	165	115	290	68	78,0	56	0,069	M16	8	250	36000	630	195	265	20,600	754,00
		120									660	200	265			
		125									700	210	265			
CE14-175*	175	125	300	68	78,0	56	0,079	M16	8	250	40000	650	185	250	21,400	778,00
		130									680	190	250			
		135									720	200	250			
CE14-185*	185	135	330	86	96,0	71	0,079	M16	10	250	55000	815	175	230	33,400	913,00
		140									60000	875	185	230		
		145									65000	896	190	230		
CE14-195*	195	140	350	86	96,0	71	0,079	M16	12	250	66000	950	210	265	38,000	1.413,00
		150									76000	1000	220	265		
		155									82000	1100	230	265		
CE14-220*	220	160	370	104	114,0	88	0,079	M16	15	250	95000	1200	190	235	54,000	1.705,00
		165									102000	1300	195	235		
		170									110000	1300	200	235		
CE14-240*	240	170	405	109	122,0	92	0,079	M20	12	490	120000	1500	210	260	67,000	2.232,00
		180									140000	1600	220	260		
		190									160000	1700	225	260		
CE14-260*	260	190	430	120	133,0	103	0,090	M20	14	490	165000	1700	205	250	82,000	2.626,00
		200									185000	1900	220	250		
		210									205000	2000	225	250		

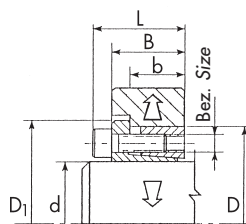

Type CE16

Bezeichnung Part No.	Abmessung Dimension						Schrauben Screws			bei Anzugsmoment M _s übertragbar with tightening torque M _s applied		Flächen- pressung Pressure		Gewicht Weight (kg)	€/Stück each				
	d	D	D ₁	b	B	L	Bezeichnung Part No.	Anzahl No.	Anzugs- moment tightening torque M _s	Drehmoment Torque	Axialkraft Axial force	Welle Shaft	Nabe Hub						
																M	F	P _w	P _N
																(mm)	(mm)	(mm)	(mm)
CE16-14x55*	14	55	62	23	31	39	M8 x 25	4	41	287	41	311	103	0,480	33,10				
CE16-16x55*	16	55	62	23	31	39	M8 x 25	4	41	329	41	272	103	0,460	33,10				
CE16-18x55*	18	55	62	23	31	39	M8 x 25	4	41	370	41	242	103	0,450	33,10				
CE16-19x55*	19	55	62	23	31	39	M8 x 25	4	41	390	41	229	103	0,440	33,10				
CE16-20x55*	20	55	62	23	31	39	M8 x 25	4	41	410	41	218	103	0,440	33,10				
CE16-22x55*	22	55	62	23	31	39	M8 x 25	4	41	451	41	198	103	0,420	33,10				
CE16-24x55*	24	55	62	23	31	39	M8 x 25	4	41	492	41	182	103	0,410	33,10				
CE16-25x55*	25	55	62	23	31	39	M8 x 25	4	41	513	41	174	103	0,410	33,10				
CE16-28x55*	28	55	62	23	31	39	M8 x 25	4	41	575	41	156	103	0,390	33,10				
CE16-30x55*	30	55	62	23	31	39	M8 x 25	4	41	616	41	145	103	0,370	33,10				
CE16-24x65*	24	65	72	23	31	39	M8 x 25	5	41	616	51	227	111	0,600	38,60				
CE16-25x65*	25	65	72	23	31	39	M8 x 25	5	41	641	51	218	111	0,600	38,60				
CE16-28x65*	28	65	72	23	31	39	M8 x 25	5	41	718	51	194	111	0,580	38,60				
CE16-30x65*	30	65	72	23	31	39	M8 x 25	5	41	770	51	182	111	0,570	38,60				
CE16-32x65*	32	65	72	23	31	39	M8 x 25	5	41	821	51	170	111	0,540	38,60				
CE16-35x65*	35	65	72	23	31	39	M8 x 25	5	41	898	51	156	111	0,520	38,60				
CE16-38x65*	38	65	72	23	31	39	M8 x 25	5	41	975	51	143	111	0,480	38,60				
CE16-40x65*	40	65	72	23	31	39	M8 x 25	5	41	1026	51	136	111	0,460	38,60				
CE16-30x80*	30	80	88	26	34	42	M8 x 25	7	41	1077	72	227	108	1,040	47,30				
CE16-32x80*	32	80	88	26	34	42	M8 x 25	7	41	1150	72	213	108	1,000	47,30				
CE16-35x80*	35	80	88	26	34	42	M8 x 25	7	41	1257	72	194	108	0,960	47,30				
CE16-38x80*	38	80	88	26	34	42	M8 x 25	7	41	1364	72	179	108	0,930	47,30				
CE16-40x80*	40	80	88	26	34	42	M8 x 25	7	41	1436	72	170	108	0,900	47,30				
CE16-42x80*	42	80	88	26	34	42	M8 x 25	7	41	1509	72	162	108	0,900	47,30				
CE16-45x80*	45	80	88	26	34	42	M8 x 25	7	41	1616	72	151	108	0,870	47,30				
CE16-48x80*	48	80	88	26	34	42	M8 x 25	7	41	1723	72	142	108	0,850	47,30				
CE16-50x80*	50	80	88	26	34	42	M8 x 25	7	41	1796	72	136	108	0,820	47,30				

Nachdruck, auch auszugsweise, verboten.
Reproduction, also in parts, forbidden.

Zuwiderhandlungen werden urheberrechtlich verfolgt.
Any infringement will be prosecuted under the copyright act law.

Irrtum/sowie Änderungen durch technischen Fortschritt vorbehalten.
Subject to correction or change without notice due to technological progress.

Bezüglich der Haftung und Lieferung verweisen wir auf unsere allgemeinen Geschäftsbedingungen.
Concerning liability and delivery consult our general terms and conditions.

optibelt

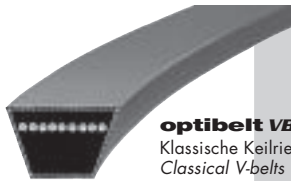

optibelt VB
Klassische Keilriemen
Classical V-belts

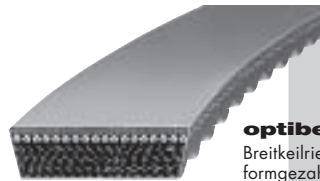

optibelt SUPER VX
Breitkeilriemen, flankenoffen,
formgezahnt
Variable speed belts,
raw edge, moulded cogged



optimax HF
Endlose Hochleistungs-
Flachriemen
High performance
flat belts

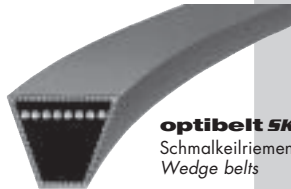

optibelt SK
Schmalkeilriemen
Wedge belts



optibelt SUPER DVX
Doppel-Breitkeilriemen,
flankenoffen, formgezahnt
Double section variable speed
belts, raw edge, moulded cogged



optimat DE
Endliche Keilriemen
DIN 2216, gelocht
Open-ended V-belt, punched



optibelt RED POWER II
Hochleistungs-Schmalkeilriemen,
wartungsfrei
High performance wedge belts,
service-free

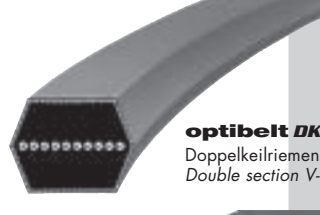

optibelt DK
Doppelkeilriemen
Double section V-belts



optibelt LB
Gliederkeilriemen
Link belting



optibelt SUPER TX M-5
Keilriemen, flankenoffen, formgezahnt
V-belts, raw edge, moulded cogged

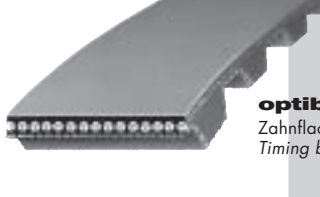

optibelt ZR
Zahnflachriemen
Timing belts



optibelt RR
Kunststoffrundriemen
Plastic round section
belting



optibelt KB
Kraftbänder
Kraftbands

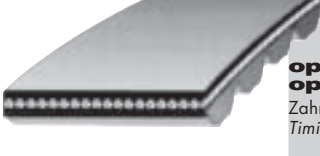

**optibelt OMEGA
optibelt OMEGA HP**
Zahnflachriemen, wartungsfrei
Timing belts, service-free



optibelt KK
Kunststoffkeilriemen
Plastic V-belt

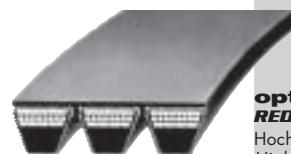

**optibelt KB
RED POWER II**
Hochleistungs-Kraftbänder
High performance Kraftbands



optibelt HTD® D
Doppel-Zahnflachriemen
Double section timing belts

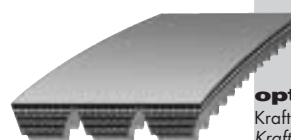

optibelt KBX
Kraftbänder, flankenoffen
Kraftbands, raw edge



**optibelt ALPHA
optibelt ALPHA linear/V
optibelt ALPHAflex**
Zahnflachriemen aus Polyurethan
Polyurethane timing belts

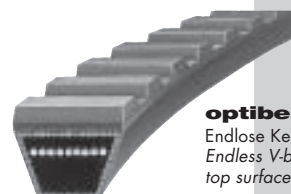

optibelt PKR
Endlose Keilriemen mit Auflage
Endless V-belts with special
top surfaces

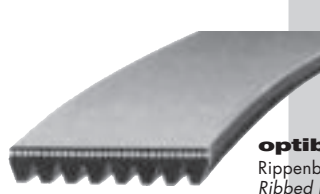

optibelt RB
Rippenbänder
Ribbed belts

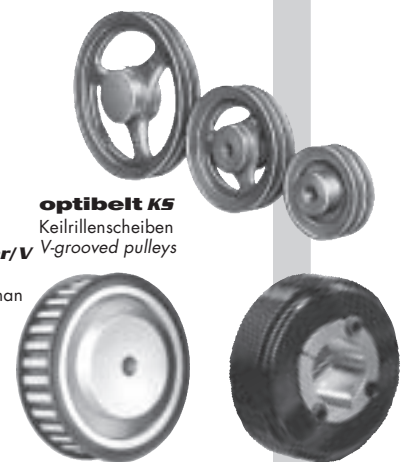

optibelt K5
Keilrillenscheiben
V-grooved pulleys

optibelt ZRS
Zahnriemenscheiben
Timing belt pulleys

optibelt RBS
Rippenbandscheiben
Ribbed belt pulleys

Optibelt GmbH

Postfach 10 01 32 · D-37669 Hötter/Germany · Tel. +49 (0) 52 71 - 6 21 · Fax +49 (0) 52 71 - 97 62 00

info@optibelt.com · www.optibelt.com

Ein Unternehmen der Arntz Optibelt Gruppe · A member of the Arntz Optibelt Group