

ConCar

POWER TRANSMISSION SYSTEMS

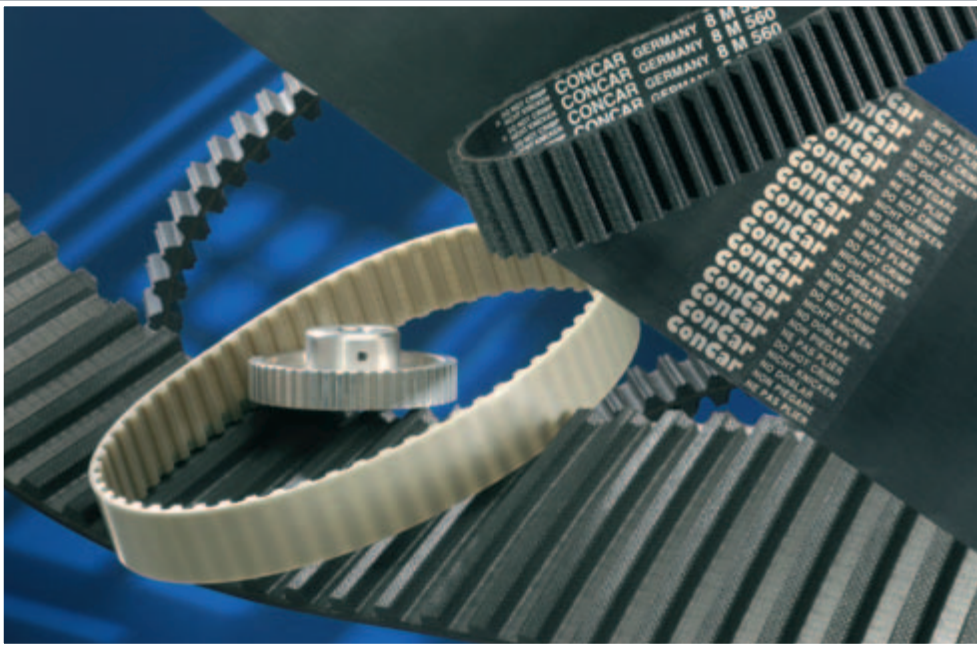

Industrie-
riemen

Industrial
Belts

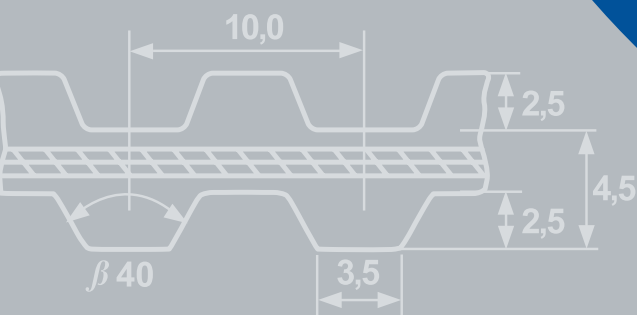
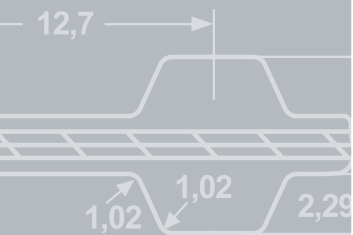

Brutto-Preisliste
Gross Price List

2004

Gültig ab / Effective from
1. 12. 2004

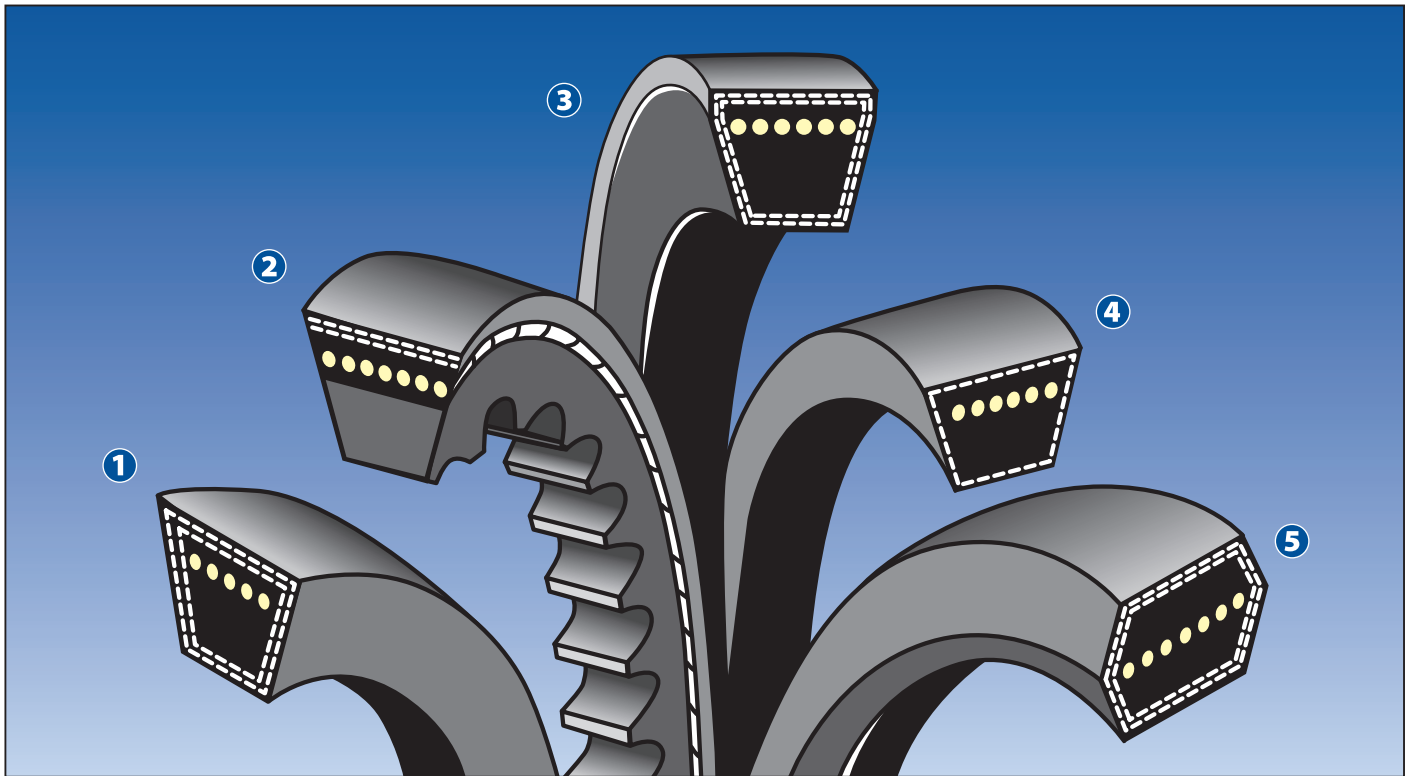

- 1 Ummantelte Schmalkeilriemen (DIN 7753)
Wrapped narrow V-belts (DIN 7753)
- 2 Flankenoffene Hochleistungs-Schmalkeilriemen (DIN 7753)
High performance narrow V-belts (DIN 7753)
- 3 Ummantelte Schmalkeilriemen nach US-Norm RMA/MPTA
Wrapped V-belts acc. US norm RMA/MPTA
- 4 Klassische ummantelte Keilriemen (DIN 2215)
Classical wrapped V-belts (DIN 2215)
- 5 Doppelkeilriemen (DIN 7722)
Hexagonal belts (DIN 7722)
- 6 Breitkeilriemen
Variable speed belts
- 7 Verbundriemen
Power belts
- 8 Rippenriemen
Poly-V-belts

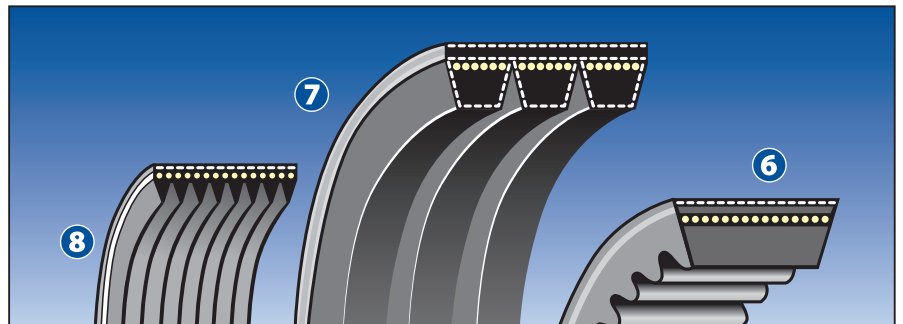

Kfz-Riemen Automotive belts

Hochleistungs-Schmalkeilriemen
High performance narrow V-belts

Steuerriemen
Timing belts

Rippenriemen
Poly-V-belts



<u>Keilriemen</u>	Seite
Breitkeilriemen	Vari-Speed - flankenoffen, formgezahnt..... 24 -25 USA - Standard - flankenoffen, formgezahnt..... 26
Doppelkeilriemen	ummantelt..... 19
Gliederkeilriemen	Meterware..... 29
Klassische Keilriemen	ummantelt, DIN 2215 / ISO 4184..... 12 - 18 REX - flankenoffen, formgezahnt..... 22 - 23
Keilrippenriemen	Neoprene..... 32
Kraftbänder	Verbundkeilriemen ummantelt..... 27 - 28
Lochkeilriemen	endlich, grün, DIN 2216..... 29
Polyurethan Keilriemen	Meterware, 80 - 100° Shore A..... 89 - 91
Schmalkeilriemen	ummantelt, DIN 7753 / ISO 4184..... 9 - 10 USA - Standard RMA/ MPTA..... 11 REX - flankenoffen, formgezahnt..... 20 - 21
Weitwinkelkeilriemen	Polyurethan, 60° Winkel, Einzel-KR/ Verbund-KR..... 30 - 31
<u>Zahnflachriemen</u>	
HTD / RPP - Zahnflachriemen	Neoprene, einfach gezahnt, metrisch..... 48 - 52 Neoprene, doppelt gezahnt, metrisch..... 53 - 55 Neoprene, RPP Silver..... 56 - 57 Neoprene, RPP Gold mit Glasfaser - Zugstrang..... 58 - 59
Neoprene Zahnflachriemen	einfach gezahnt, zöllig..... 33 - 43 doppelt gezahnt, zöllig..... 43 - 47 Meterware, zöllig..... 85
Polyurethan - Zahnflachriemen	Poly Chain..... 60 - 61 einfach gezahnt mit Stahllitzen, metrisch..... 73 - 77 doppelt gezahnt mit Stahllitzen, metrisch..... 78 Meterware - endlich und endlos verschweißt..... 79 - 85 Flex mit endlos gespulten Stahllitzen..... 86
STS / STD - Zahnflachriemen	Neoprene, einfach gezahnt, metrisch..... 62 - 67 Neoprene, doppelt gezahnt, metrisch..... 68 - 72
<u>Flachriemen</u>	
Neoprene - Flachriemen	endlos gewebt..... 86
Polyurethan - Flachriemen	endlos gewebt..... 87
<u>Rundriemen</u>	
Rundriemen	Polyurethan, Meterware, 80 - 100° Shore A..... 89 - 91
Verbindungswerkzeuge 88
<u>Sonstiges</u>	
	Lieferbedingungen..... 5
	Sonderausführungen und technische Daten..... 6 - 8

<u>V - Belts</u>		Page
Banded - Belts	team - belts, wrapped.....	27 - 28
Classical Section V - Belts	wrapped , DIN 2215 / ISO 4184.....	12 - 18
	REX - raw edge, moulded cogged.....	22 - 23
Double V - Belts	wrapped, hexagonal.....	19
Link - Belts	open ended.....	29
Narrow V - Belts	wrapped, DIN 7753 / ISO 4184.....	9 - 10
	USA - Standard RMA/ MPTA.....	11
	REX - raw edge, moulded cogged.....	20 - 21
Polyurethane V - Belts	open ended, 80 - 100° Shore A.....	89 - 91
Punched Belts	open ended, green, DIN 2216.....	29
Ribbed Belts	Neoprene.....	32
Variable Speed Belts	Vari-Speed - raw edge, moulded cogged.....	24 - 25
	USA - Standard - raw edge, moulded cogged.....	26
Wide Angle Belts	Polyurethane, 60° angle, single/ banded.....	30 - 31
<u>Timing Belts</u>		
HTD / RPP - Timing Belts	Neoprene, single toothed, metric.....	48 - 52
	Neoprene, double toothed, metric.....	53 - 55
	Neoprene, RPP Silver.....	56 - 57
	Neoprene, RPP Gold with fibreglass cord.....	58 - 59
Neoprene Timing - Belts	single toothed, inch.....	33 - 43
	double toothed, inch.....	43 - 47
	open ended, inch.....	85
Polyurethane Timing - Belts	Poly Chain	60 - 61
	single toothed with steel cord, metric.....	73 - 77
	double toothed with steel cord, metric.....	78
	open ended and jointed.....	79 - 85
	Flex with endless spooled steel cord.....	86
STS / STD Timing Belts	Neoprene, single toothed, metric.....	62 - 67
	Neoprene, double toothed, metric.....	68 - 72
<u>Flat Belts</u>		
Neoprene - Flat Belts	endless woven.....	86
Polyurethane - Flat Belts	endless woven.....	87
<u>Round Belts</u>		
Round Belts	Polyurethan, open ended, 80 - 100° Shore A.....	89 - 91
FittingTools	88
<u>Sundries</u>		
	Delivery terms.....	5
	Special constructions and technical data.....	6 - 8

Lieferbedingungen

Die Mindestbestellmenge beträgt je Inlandsauftrag EUR 50.- netto.

Lieferungen unter EUR 50.- werden mit EUR 10.- Mindermengenzuschlag berechnet.

Die Lieferungen erfolgen je Inlandsauftrag ab einem Warennettowert von EUR 50.- frei Haus inklusive Verpackung. Darunter unfrei ab Werk exklusive Verpackung.

Die Mindestbestellmenge beträgt je Exportauftrag EUR 125.- Warennettowert.

Die Preise verstehen sich unfrei ab Werk inklusive Verpackung.

Die hier aufgeführten Preise verstehen sich für Inlandsaufträge zuzüglich der gültigen Mehrwertsteuer.

Alle früheren Preislisten werden hiermit ungültig. Die Preise sind freibleibend.

Es gelten unsere Allgemeinen Geschäftsbedingungen.

Terms of delivery

Minimum value of export orders is EUR 125.- net value.

Prices of goods are ex works incl. packing.

All former price lists are invalid.

Our general terms of business are valid.

ConCar

Sonderausführungen und technische Daten

Special constructions and technical data Delivery terms

ConCar liefert Spitzenprodukte der Antriebs und Fördertechnik.

ConCar Antriebs- und Förderriemen entsprechen den internationalen Normen und Spezifikationen und werden auch in einer Vielzahl von Sonderausführungen für jeden technischen Anwendungsfall gefertigt.

ConCar Gummi-Keilriemen sind bedingt ölbeständig, hitzebeständig (bis 70°C), elektrisch leitfähig und schwer entflammbar.

ConCar Gummi-Keilriemen mit "LOBA"-Kennzeichnung sind zum Einsatz im Bergbau vom Landesoberbergamt Nordrhein-Westfalen freigegeben.

ConCar Gummi-Keilriemen mit dem "API"-Kennzeichen sind gemäß Zertifikat Nr. 7677 des American Petroleum Institute vom 08. Februar 1979 geeignet für den Einsatz auf Ölfeldern und in der Erdölindustrie.

ConCar Gummi-Keilriemen "satzgleich" werden in eingeschränkten Längentoleranzen gefertigt, welche die vorgegebenen Grenzwerte aller Normen wesentlich unterschreiten.

Preisauflage für Sonderausführungen:

extra ölbeständig 50 %

extra hitzebeständig 35 %

elektrisch leitfähig, Kennzeichnung 20%

Bergbau mit "LOBA"-Kennzeichnung 20%

Weitere Spezialqualitäten und Sonderlängen auf Anfrage

ConCar V-Belts are first class products of driving and conveyor technics.

ConCar Power Transmission und Conveyor Belts correspond to international standards and specifications.

ConCar Power Transmission und Conveyor Belts are be produced in many different special constructions for every application.

ConCar Rubber V-Belts are limited oil-resistant, heat resistant up to 70°C, electrical conductive and hardly inflammable.

ConCar Rubber V-Belt with "LOBA"-sign are allowed for using in mining.

ConCar Rubber V-Belt branded with the "API"-monogram may be used in the oil drilling and processing industrie.

ConCar Rubber V-Belts "satzgleich" are produced within very small length tolerances, which essentially remain under the passed regulations of all standards.

Surcharge of price for special constructions:

extra oil resistant 50 %

extra heat resistant 35 %

electrical conductivity, marking 20 %

for mining with "LOBA" marking 20%

Further special qualities and non standard lengths on request.

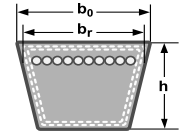

ConCar Schmalkeilriemen nach DIN 7753 Teil 1 und BS 3790 Narrow Belts to DIN 7753 Part 1 and BS 3790

Profil Section	Abmessung Dimension $b_0 \times h$	Profilbreite unten Section base width	Wirklänge Pitch width b_r	Riemenlänge / Belt length				Empfohlener Mindestdurchmesser Recommended minimum pulley diameter	Riemengewicht Belt weight = kg/m	
				Nennlänge Nominal length	Außenzlänge Outside length L_a	Wirklänge Pitch length L_w/L_p	Innenlänge Inside length L_i			
SPZ	9,7 x 8	4,2	8,5	Wirklänge Pitch length L_w/L_p	$L_a = L_w/L_p + 13$ $L_a = L_i + 51$	—	$L_i = L_w/L_p - 38$ $L_i = L_a - 51$	Wirklänge Pitch length d_w/d_p	63	0.070
SPA	12,7 x 10	5,8	11,0		$L_a = L_w/L_p + 18$ $L_a = L_i + 63$	—	$L_i = L_w/L_p - 45$ $L_i = L_a - 63$		90	0.119
SPB	16,3 x 13	7,3	14,0		$L_a = L_w/L_p + 22$ $L_a = L_i + 82$	—	$L_i = L_w/L_p - 60$ $L_i = L_a - 82$		140	0.194
SPC	22 x 18	9,6	19,0		$L_a = L_w/L_p + 30$ $L_a = L_i + 113$	—	$L_i = L_w/L_p - 83$ $L_i = L_a - 113$		224	0.360
19	18,6 x 15	8,3	16,0		$L_a = L_w/L_p + 25$ $L_a = L_i + 94$	—	$L_i = L_w/L_p - 69$ $L_i = L_a - 94$		180	0.250

ConCar Schmalkeilriemen nach USA-Standard RMA/MPTA / Narrow Belts to USA-Standard RMA/MPTA

	Abmessung Dimension $b_0 \times h$	Profilbreite unten Section base width	Wirklänge Pitch width b_r	Außenzlänge Outside length L_a	Wirklänge Pitch length L_w/L_p	Innenlänge Inside length L_i	Außendurchmesser Outside diameter d_a	Riemengewicht Belt weight = kg/m
3V/9N	9 x 8	4,2	—	—	$L_w/L_p = L_a - 4$	$L_i = L_a - 42$	63	0.070
5V/15N	15 x 13	7,3	—	—	$L_w/L_p = L_a - 11$	$L_i = L_a - 71$	140	0.194
8V/25N	25 x 23	9,6	—	—	—	$L_i = L_a - 120$	315	0.567

ConCar REX Formgezahnte, flankenoffene Schmalkeilriemen nach DIN 7753 Teil 1 und BS 3790 Moulded cogged raw edge Narrow Belts to DIN 7753 Part 1 and BS 3790

	Abmessung Dimension $b_0 \times h$	Profilbreite unten Section base width	Wirklänge Pitch width b_r	Wirklänge Pitch length L_w/L_p	Außenzlänge Outside length L_a	Innenlänge Inside length L_i	Außendurchmesser Outside diameter d_a	Riemengewicht Belt weight = kg/m
XPZ	9,7 x 8	4,2	8,5	Wirklänge Pitch length L_w/L_p	$L_a = L_w/L_p + 13$ $L_a = L_i + 51$	$L_i = L_w/L_p - 38$ $L_i = L_a - 51$	56	0.065
XPA	12,7 x 10	5,8	11,0		$L_a = L_w/L_p + 18$ $L_a = L_i + 63$	$L_i = L_w/L_p - 45$ $L_i = L_a - 63$	71	0.111
XPB	16,3 x 13	7,3	14,0		$L_a = L_w/L_p + 22$ $L_a = L_i + 82$	$L_i = L_w/L_p - 60$ $L_i = L_a - 82$	112	0.183
XPC	22 x 18	9,6	19,0		$L_a = L_w/L_p + 30$ $L_a = L_i + 113$	$L_i = L_w/L_p - 83$ $L_i = L_a - 113$	180	0.340

ConCar REX Formgezahnte, flankenoffene Schmalkeilriemen nach USA-Standard RMA/MPTA Moulded cogged raw edge Narrow Belts to USA-Standard RMA/MPTA

	Abmessung Dimension $b_0 \times h$	Profilbreite unten Section base width	Wirklänge Pitch width b_r	Außenzlänge Outside length L_a	Wirklänge Pitch length L_w/L_p	Innenlänge Inside length L_i	Außendurchmesser Outside diameter d_a	Riemengewicht Belt weight = kg/m
3VX	9 x 8	4,2	—	—	$L_w/L_p = L_a - 4$	$L_i = L_a - 42$	56	0.065
5VX	15 x 13	7,3	—	—	$L_w/L_p = L_a - 11$	$L_i = L_a - 71$	112	0.183

ConCar REX Formgezahnte, flankenoffene Keilriemen nach DIN 2215 und BS 1440 Moulded cogged raw edge V-Belts to DIN 2215 and BS 1440

	Abmessung Dimension $b_0 \times h$	Profilbreite unten Section base width	Wirklänge Pitch width b_r	Innenlänge Inside length L_i	Außenzlänge Outside length L_a	Wirklänge Pitch length L_w/L_p	Innenlänge Inside length L_i	Außendurchmesser Outside diameter d_a	Riemengewicht Belt weight = kg/m
ZX/X10	10 x 6	5,9	8,5	Innenlänge Inside length L_i	$L_a = L_i + 38$ $L_a = L_w/L_p + 16$	$L_w/L_p = L_i + 22$ $L_w/L_p = L_a - 16$	—	40	0.062
AX/X13	13 x 8	7,5	11,0		$L_a = L_i + 50$ $L_a = L_w/L_p + 20$	$L_w/L_p = L_i + 30$ $L_w/L_p = L_a - 20$	—	63	0.099
BX/X17	17 x 11	9,4	14,0		$L_a = L_i + 69$ $L_a = L_w/L_p + 29$	$L_w/L_p = L_i + 40$ $L_w/L_p = L_a - 29$	—	90	0.165
CX/X22	22 x 14	12,3	19,0		$L_a = L_i + 88$ $L_a = L_w/L_p + 30$	$L_w/L_p = L_i + 58$ $L_w/L_p = L_a - 30$	—	140	0.276

ConCar Keilriemen nach DIN 2215 und BS 1440 / V-Belts to DIN 2215 and BS 1440

	Abmessung Dimension $b_0 \times h$	Profilbreite unten Section base width	Wirklänge Pitch width b_r	Innenlänge Inside length L_i	Außenzlänge Outside length L_a	Wirklänge Pitch length L_w/L_p	Innenlänge Inside length L_i	Außendurchmesser Outside diameter d_a	Riemengewicht Belt weight = kg/m
5	5 x 3	2,8	4,2	Innenlänge Inside length L_i	$L_a = L_i + 19$ $L_a = L_w/L_p + 8$	$L_w/L_p = L_i + 11$ $L_w/L_p = L_a - 8$	—	20	0.018
Y/6	6 x 4	3,3	5,3		$L_a = L_i + 25$ $L_a = L_w/L_p + 10$	$L_w/L_p = L_i + 15$ $L_w/L_p = L_a - 10$	—	28	0.026
8	8 x 5	4,5	6,7		$L_a = L_i + 31$ $L_a = L_w/L_p + 12$	$L_w/L_p = L_i + 19$ $L_w/L_p = L_a - 12$	—	40	0.042
Z/10	10 x 6	5,9	8,5		$L_a = L_i + 38$ $L_a = L_w/L_p + 16$	$L_w/L_p = L_i + 22$ $L_w/L_p = L_a - 16$	—	50	0.065
A/13	13 x 8	7,5	11,0		$L_a = L_i + 50$ $L_a = L_w/L_p + 20$	$L_w/L_p = L_i + 30$ $L_w/L_p = L_a - 20$	—	71	0.112
B/17	17 x 11	9,4	14,0		$L_a = L_i + 69$ $L_a = L_w/L_p + 29$	$L_w/L_p = L_i + 40$ $L_w/L_p = L_a - 29$	—	122	0.198
20	20 x 12,5	11,4	17,0		$L_a = L_i + 79$ $L_a = L_w/L_p + 31$	$L_w/L_p = L_i + 48$ $L_w/L_p = L_a - 31$	—	160	0.268
C/22	22 x 14	12,3	19,0		$L_a = L_i + 88$ $L_a = L_w/L_p + 30$	$L_w/L_p = L_i + 58$ $L_w/L_p = L_a - 30$	—	180	0.330
25	25 x 16	14,0	21,0		$L_a = L_i + 100$ $L_a = L_w/L_p + 39$	$L_w/L_p = L_i + 61$ $L_w/L_p = L_a - 39$	—	250	0.422
D/32	32 x 20	18,2	27,0		$L_a = L_i + 126$ $L_a = L_w/L_p + 51$	$L_w/L_p = L_i + 75$ $L_w/L_p = L_a - 51$	—	355	0.675
E/40	40 x 25	22,8	32,0		$L_a = L_i + 157$ $L_a = L_w/L_p + 77$	$L_w/L_p = L_i + 80$ $L_w/L_p = L_a - 77$	—	500	1.030

ConCar Kfz-Keilriemen nach DIN 7753 Blatt 3, BS AU 150 und ISO 2790 Fan-Belts to DIN 7753 Part 3, BS AU 150 and ISO 2790

	Abmessung Dimension $b_0 \times h$	Profilbreite unten Section base width	Wirklänge Pitch width b_r	Außenzlänge Outside length L_a	Wirklänge Pitch length L_w/L_p	Innenlänge Inside length L_i	Außendurchmesser Outside diameter d_a	Riemengewicht Belt weight = kg/m
AV10/9,5	10 x 8	4,9	8,5	—	$L_w/L_p = L_a - 13$	$L_i = L_a - 51$	—	0.070
AV13/12,5	13 x 10	5,8	11,0	—	$L_w/L_p = L_a - 18$	$L_i = L_a - 63$	—	0.119

ConCar REX Kfz-Keilriemen nach DIN 7753 Blatt 3, BS AU 150 und ISO 2790 Moulded cogged raw edge Fan-Belts to DIN 7753 Part 3, BS AU 150 and ISO 2790

	Abmessung Dimension $b_0 \times h$	Profilbreite unten Section base width	Wirklänge Pitch width b_r	Außenzlänge Outside length L_a	Wirklänge Pitch length L_w/L_p	Innenlänge Inside length L_i	Außendurchmesser Outside diameter d_a	Riemengewicht Belt weight = kg/m
AVX10/9,5	10 x 8	4,9	8,5	—	$L_w/L_p = L_a - 13$	$L_i = L_a - 48$	—	0.065
AVX13/12,5	13 x 10	5,8	11,0	—	$L_w/L_p = L_a - 18$	$L_i = L_a - 56$	—	0.111

Kraftband-Profile, Hochleistungs-Schmalkeilriemen
Banded-Belt Sections, High Capacity Narrow V-Belt

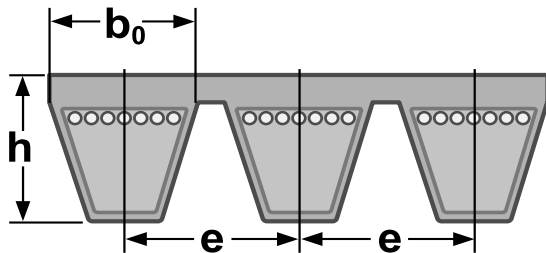

Profil/ Section	3V/9J	5V/15J	8V/25J	SPB	SPC
$b_0 \approx$	9	15	25	16,5	22
$h \approx$	9,9	15,1	25,5	15,6	22,6
$e \approx$	10,3	17,5	28,6	19	25,5

Kraftband-Profile, Klassische Keilriemen
Banded-Belt Sections, Classical V-Belt

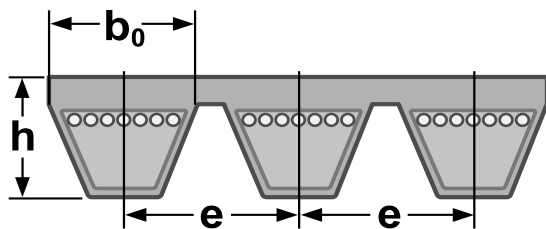

Profil/ Section	A/HA	B/HB	C/HC	C/HC
$b_0 \approx$	13	17	22	32
$h \approx$	9,9	13	16,2	22,4
$L_a \approx L_i +$	36	62	75	111
$e \approx$	15,88	19,05	25,4	36,53

Doppelkeilriemen-Profile
Double V-Belt Sections

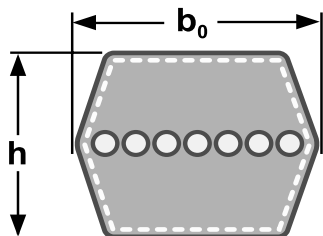

Profil/ Section	AA/HAA	BB/HBB	CC/HCC	DD/HDD	22 x 22	25 x 22
$b_0 \approx$	13	17	22	32	22	25
$h \approx$	10	13	17	25	22	22

Meßlatte für Keilriemen bis 2000 mm
Measuring gauge for V-Belts up to 2000 mm

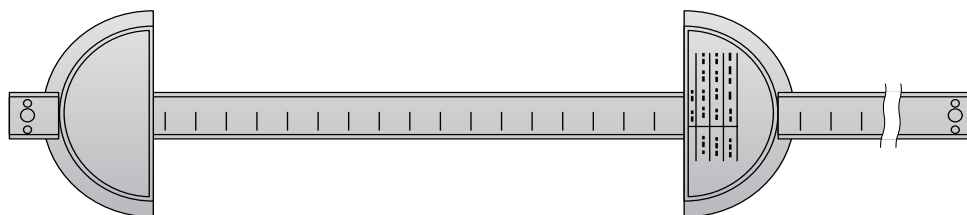

Spannkrafttester
Tension gauge



Preise auf Anfrage.
Prices on request.

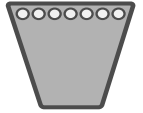

Hochleistungs - Schmalkeilriemen DIN 7753/ ISO 4184 - ummantelt
High Capacity Narrow V- Belts DIN 7753/ ISO 4184 - wrapped

SPZ			AV 10/9,5			SPA			AV 13/12,5		
LW/LD= Richtlänge pitch length mm	LA= Außenlänge outside length mm	Stück piece Euro	LW/LD= Richtlänge pitch length mm	LA= Außenlänge outside length mm	Stück piece Euro	LW/LD= Richtlänge pitch length mm	LA= Außenlänge outside length mm	Stück piece Euro	LW/LD= Richtlänge pitch length mm	LA= Außenlänge outside length mm	Stück piece Euro
487	500	6,00	1500	1513	11,10	732	750	8,30			
512	525	6,00	1512	1525	12,20	757	775	8,30			
562	575	6,00	1537	1550	12,20	782	800	8,30			
587	600	6,00	1562	1575	12,20	800	818	8,30			
612	625	6,00	1587	1600	12,20	807	825	9,00			
630	643	6,40	1600	1613	12,20	832	850	9,00			
637	650	6,40	1612	1625	13,00	850	868	9,00			
662	675	6,40	1637	1650	13,00	857	875	9,00			
670	685	6,40	1662	1675	13,00	882	900	9,00			
687	700	6,40	1687	1700	13,00	900	918	9,00			
710	725	6,40	1700	1713	13,00	907	925	10,30			
722	735	6,40	1712	1725	13,50	932	950	10,30			
737	750	6,40	1737	1750	13,50	950	968	10,30			
750	763	6,40	1762	1775	13,50	957	975	10,30			
762	775	6,40	1787	1800	13,50	982	1000	10,30			
772	785	6,40	1800	1813	13,50	1000	1018	10,30			
787	800	6,40	1812	1825	14,00	1007	1025	11,90			
800	813	6,40	1837	1850	14,00	1032	1050	11,90			
812	825	6,80	1862	1875	14,00	1060	1075	11,90			
825	838	6,80	1887	1900	14,00	1082	1100	11,90			
837	850	6,80	1900	1913	14,00	1107	1125	11,90			
850	864	6,80	1912	1925	14,70	1120	1138	11,90			
862	875	6,80	1937	1950	14,70	1132	1150	12,90			
875	888	6,80	1987	2000	14,70	1157	1175	12,90			
887	900	6,80	2000	2013	14,70	1180	1200	12,90			
900	913	6,80	2037	2050	15,60	1207	1225	12,90			
912	925	7,10	2062	2075	15,60	1232	1250	12,90			
925	940	7,10	2087	2100	15,60	1250	1268	12,90			
937	950	7,10	2120	2133	15,60	1257	1275	13,90			
950	965	7,10	2137	2150	15,60	1272	1290	13,90			
962	975	7,10	2187	2200	15,60	1282	1300	13,90			
987	1000	7,10	2207	2220	16,80	1307	1325	13,90			
1000	1016	7,10	2240	2253	16,80	1320	1338	13,90			
1012	1025	8,30	2287	2300	17,50	1332	1350	14,60			
1024	1037	8,30	2360	2373	17,50	1357	1375	14,60			
1037	1050	8,30	2500	2513	18,90	1382	1400	14,60			
1047	1060	8,30	2650	2663	19,70	1400	1418	14,60			
1060	1075	8,30	2800	2813	21,10	1407	1425	15,80			
1077	1090	8,30	3000	3013	21,70	1432	1450	15,80			
1087	1100	8,30	3150	3163	23,20	1457	1475	15,80			
1112	1125	8,30	3350	3363	25,20	1482	1500	15,80			
1120	1133	8,30	3550	3563	25,90	1500	1518	15,80			
1137	1150	8,90				1507	1525	16,30			
1162	1175	8,90				1532	1550	16,30			
1180	1193	8,90				1557	1575	16,30			
1187	1200	8,90				1582	1600	16,30			
1202	1215	8,90				1600	1618	16,30			
1212	1225	8,90				1607	1625	17,60			
1237	1250	8,90				1632	1650	17,60			
1250	1263	8,90				1657	1675	17,60			
1262	1275	10,10				1682	1700	17,60			
1287	1300	10,10				1700	1718	17,60			
1312	1325	10,10				1707	1725	18,40			
1320	1333	10,10				1732	1750	18,40			
1337	1350	10,90				1757	1775	18,40			
1362	1375	10,90				1782	1800	18,40			
1387	1400	10,90				1800	1818	18,40			
1400	1413	10,90				1807	1825	19,70			
1412	1425	11,10				1832	1850	19,70			
1437	1450	11,10				1857	1875	19,70			
1462	1475	11,10				1882	1900	19,70			
1487	1500	11,10				1900	1918	19,70			

Gewicht/ weight = 0,070 kg/m

Gewicht/ weight = 0,119 kg/m



Profil/Section 3V / 9 N			Profil/Section 5V / 15 N			Profil/Section 8V / 25 N		
Code - Nr.	LA= Außenlänge outside length mm	Stück piece Euro	Code - Nr.	LA= Außenlänge outside length mm	Stück piece Euro	Code - Nr.	LA= Außenlänge outside length mm	Stück piece Euro
3 V 265	9 N 673	6,40	5 V 500	15 N 1270	18,80	8 V 1000	25 N 2540	89,90
3 V 280	9 N 711	6,40	5 V 530	15 N 1346	19,20	8 V 1060	25 N 2692	96,10
3 V 300	9 N 762	6,40	5 V 560	15 N 1422	19,70	8 V 1120	25 N 2845	103,40
3 V 315	9 N 800	6,40	5 V 600	15 N 1524	22,00	8 V 1180	25 N 2997	106,80
3 V 335	9 N 851	6,80	5 V 630	15 N 1600	23,60	8 V 1250	25 N 3175	108,70
3 V 355	9 N 902	6,80	5 V 670	15 N 1702	25,00	8 V 1320	25 N 3353	115,60
3 V 375	9 N 952	7,10	5 V 710	15 N 1803	26,40	8 V 1400	25 N 3556	121,40
3 V 400	9 N 1016	7,10	5 V 750	15 N 1905	28,10	8 V 1500	25 N 3810	128,60
3 V 425	9 N 1079	8,30	5 V 800	15 N 2032	29,90	8 V 1600	25 N 4064	140,10
3 V 450	9 N 1143	8,90	5 V 850	15 N 2159	31,60	8 V 1700	25 N 4318	147,00
3 V 475	9 N 1206	8,90	5 V 900	15 N 2286	33,90	8 V 1800	25 N 4572	155,70
3 V 500	9 N 1270	10,10	5 V 950	15 N 2413	35,60	8 V 1900	25 N 4826	167,70
3 V 530	9 N 1346	10,90	5 V 1000	15 N 2540	38,00	8 V 2000	25 N 5080	175,50
3 V 560	9 N 1422	10,90	5 V 1060	15 N 2692	39,50	8 V 2120	25 N 5385	188,00
3 V 600	9 N 1524	12,20	5 V 1120	15 N 2845	42,40	8 V 2240	25 N 5690	205,00
3 V 630	9 N 1600	12,20	5 V 1180	15 N 2997	44,60	8 V 2360	25 N 5994	216,10
3 V 670	9 N 1702	13,00	5 V 1250	15 N 3175	45,70	8 V 2500	25 N 6350	232,50
3 V 710	9 N 1803	13,50	5 V 1320	15 N 3353	47,30	8 V 2650	25 N 6731	241,20
3 V 750	9 N 1905	14,00	5 V 1400	15 N 3556	52,10	8 V 2800	25 N 7112	255,30
3 V 800	9 N 2032	15,60	5 V 1500	15 N 3810	55,60	8 V 3000	25 N 7620	274,10
3 V 850	9 N 2159	15,60	5 V 1600	15 N 4064	59,40	8 V 3150	25 N 8001	292,90
3 V 900	9 N 2286	17,60	5 V 1700	15 N 4318	62,70	8 V 3350	25 N 8509	305,00
3 V 950	9 N 2413	18,50	5 V 1800	15 N 4572	66,50	8 V 3550	25 N 9017	325,80
3 V 1000	9 N 2540	18,90	5 V 1900	15 N 4826	70,20	8 V 3750	25 N 9525	342,70
3 V 1060	9 N 2692	19,80	5 V 2000	15 N 5080	74,50	8 V 4000	25 N 10160	361,60
3 V 1120	9 N 2845	21,50	5 V 2120	15 N 5385	78,90	8 V 4250	25 N 10762	382,50
3 V 1180	9 N 2997	21,90	5 V 2240	15 N 5690	84,20	8 V 4500	25 N 11430	409,40
3 V 1250	9 N 3175	23,20	5 V 2360	15 N 5994	88,10	8 V 4750	25 N 12065	429,80
3 V 1320	9 N 3353	25,20	5 V 2500	15 N 6350	92,30	8 V 5000	25 N 12700	451,00
3 V 1400	9 N 3556	25,90	5 V 2650	15 N 6731	98,80			
			5 V 2800	15 N 7112	106,90			
			5 V 3000	15 N 7620	108,10			
			5 V 3150	15 N 8001	117,70			
			5 V 3350	15 N 8509	125,40			
			5 V 3550	15 N 9017	134,50			
Gewicht/ weight = 0,070 kg/m			Gewicht/ weight = 0,194 kg/m			Gewicht/ weight = 0,575 kg/m		

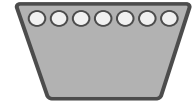

Profil/Section 8 x 5 mm				Profil/Section 10 X 6 mm Z			
Code - Nr.	Richtlänge pitch length ISO / LD mm	Innenlänge inside length mm	Stück piece Euro	Code - Nr.	Richtlänge pitch length ISO / LD mm	Innenlänge inside length mm	Stück piece Euro
	375	355	6,80	Z 14	372	355	6,80
	405	385	6,80	Z 14 ¼	397	375	6,80
	420	400	6,80	Z 15 1/2	422	400	6,80
	445	425	6,80	Z 16 1/2	447	425	6,80
	470	450	6,80	Z 17 1/2	472	450	6,80
	495	475	6,80	Z 18 1/2	497	475	6,80
	520	500	6,80	Z 19	502	480	6,80
	550	530	6,80	Z 19 1/2	522	500	6,80
	565	545	6,80	Z 20 1/3	537	515	6,80
	580	560	6,80	Z 20 ¼	547	525	6,80
	595	575	6,80	Z 21	552	530	6,80
	600	580	6,80	Z 21 1/2	562	540	6,80
	620	600	6,80	Z 22	582	560	6,80
	650	630	6,80	Z 22 1/2	597	575	7,00
	670	650	6,80	Z 24	622	600	7,00
	690	670	6,80	Z 25	652	630	7,00
	720	700	6,80	Z 25 1/2	672	650	7,00
	730	710	6,80	Z 26 1/2	692	670	7,00
	745	725	6,80	Z 28	732	710	7,00
	770	750	6,80	Z 28 1/2	747	725	7,00
	795	775	6,80	Z 29	752	730	7,00
	820	800	6,80	Z 29 1/2	772	750	7,00
	845	825	7,50	Z 30	787	765	7,00
	850	830	7,50	Z 30 1/2	797	775	7,00
	870	850	7,50	Z 31 1/2	822	800	7,20
	895	875	7,50	Z 32	842	820	7,20
	920	900	7,50	Z 32 1/2	847	825	7,20
	970	950	7,50	Z 33 1/2	872	850	7,20
	1020	1000	7,50	Z 34	887	865	7,20
	1040	1020	7,50	Z 34 1/2	897	875	7,20
	1070	1050	7,50	Z 35 1/2	922	900	7,20
	1140	1120	7,50	Z 36 1/2	947	925	7,20
	1220	1200	8,50	Z 37 1/2	972	950	7,20
	1270	1250	8,50	Z 38 1/2	997	975	7,20
				Z 39 1/2	1022	1000	7,60
				Z 40	1038	1016	7,60
				Z 40 1/2	1052	1030	7,60
				Z 41	1063	1041	7,60
				Z 41 1/2	1072	1050	7,60
				Z 42	1082	1060	7,60
				Z 42 1/2	1102	1080	7,60
				Z 43 1/2	1122	1100	7,60
				Z 44	1142	1120	7,60
				Z 44 1/2	1154	1132	7,60
				Z 45	1172	1150	7,60
				Z 46	1187	1165	7,60
				Z 46 1/2	1202	1180	7,60
				Z 47	1216	1194	8,10
				Z 48	1237	1215	8,10
				Z 48 1/2	1247	1225	8,10
				Z 49	1272	1250	8,10
				Z 50	1292	1270	8,10
				Z 51	1317	1295	8,10
				Z 52	1342	1320	8,10
				Z 53	1368	1346	8,10
				Z 54	1393	1371	8,10
				Z 55	1422	1400	8,10
				Z 56	1444	1422	9,90
				Z 57	1472	1450	9,90
				Z 58	1497	1475	9,90
				Z 59	1522	1500	9,90
				Z 60	1546	1524	10,40
Gewicht/ weight = 0,042 kg/m				Gewicht / weight = 0,065 kg/m			

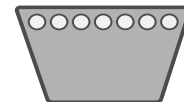

Profil / Section 10 x 6 mm Z				Profil / Section 13 x 8 mm A			
Code - Nr.	Richtlänge pitch length ISO / LD mm	Innenlänge inside length mm	Stück piece Euro	Code - Nr.	Richtlänge pitch length ISO / LD mm	Innenlänge inside length mm	Stück piece Euro
Z 61	1572	1550	10,40	A 16	437	407	7,50
Z 62	1597	1575	10,40	A 18	487	457	7,50
Z 63	1622	1600	10,40	A 19	510	480	7,50
Z 64	1648	1626	11,20	A 20	538	508	7,50
Z 65	1673	1651	11,20	A 21	565	535	7,50
Z 66	1697	1675	11,20	A 22	590	560	7,50
Z 67	1722	1700	11,20	A 22 1/2	605	575	7,50
Z 68	1747	1725	11,90	A 23	615	585	7,50
Z 69	1772	1750	11,90	A 23 1/2	630	600	7,50
Z 70	1797	1775	11,90	A 24	640	610	7,50
Z 71	1822	1800	11,90	A 24 1/2	660	630	7,50
Z 73	1872	1850	13,20	A 25	665	635	7,50
Z 75	1922	1900	13,20	A 25 1/2	680	650	7,50
Z 78	1997	1975	13,20	A 26	690	660	7,50
Z 79	2022	2000	13,50	A 26 1/2	700	670	7,50
Z 83 1/2	2142	2120	13,50	A 27	716	686	7,50
Z 88	2262	2240	14,90	A 27 1/2	730	700	7,50
Z 93	2382	2360	14,90	A 28	740	710	7,50
Z 98 1/2	2522	2500	14,90	A 29	760	730	7,50
				A 29 1/2	780	750	7,50
				A 30	797	767	7,50
				A 30 1/2	805	775	7,50
				A 31	817	787	7,50
				A 31 1/2	830	800	7,50
				A 32	843	813	7,70
				A 32 1/2	855	825	7,70
				A 33	871	841	7,70
				A 33 1/2	880	850	7,70
				A 34	893	863	7,70
				A 34 1/2	905	875	7,70
				A 35	919	889	7,70
				A 35 1/2	930	900	7,70
				A 36	944	914	8,60
				A 36 1/2	955	925	8,60
				A 37	970	940	8,60
				A 37 1/2	980	950	8,60
				A 38	995	965	8,60
				A 38 1/2	1005	975	8,60
				A 39	1020	990	8,60
				A 39 1/2	1030	1000	8,60
				A 40	1040	1016	8,60
				A 40 1/2	1060	1030	8,60
				A 41	1071	1041	8,60
				A 41 1/2	1080	1050	8,60
				A 42	1090	1060	8,60
				A 42 1/2	1105	1075	9,30
				A 43	1120	1090	9,30
				A 43 ¼	1130	1100	9,30
				A 43 1/2	1135	1105	9,30
				A 44	1150	1120	9,30
				A 45	1173	1143	9,30
				A 45 1/2	1180	1150	9,30
				A 46	1198	1168	9,30
				A 46 1/2	1210	1180	9,30
				A 47	1220	1190	10,10
				A 47 1/2	1230	1200	10,10
				A 48	1245	1215	10,10
				A 48	1250	1220	10,10
				A 48 1/2	1255	1225	10,10
				A 48 ¾	1270	1240	10,10
				A 49	1280	1250	10,10
				A 50	1300	1270	11,00

Gewicht/ weight = 0,065 kg/m

Gewicht/ weight = 0,112 kg/m

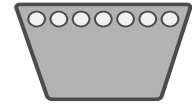

Profil / Section 13x 8 mm A				Profil / Section 13x 8 mm A			
Code - Nr.	Richtlänge pitch length ISO / LD mm	Innenlänge inside length mm	Stück piece Euro	Code - Nr.	Richtlänge pitch length ISO / LD mm	Innenlänge inside length mm	Stück piece Euro
A 51	1330	1300	11,00	A 140	3580	3550	25,00
A 52	1350	1320	11,00	A 144	3688	3658	28,20
A 53	1380	1350	11,00	A 148	3780	3750	28,20
A 54	1405	1375	11,00	A 157 1/2	4030	4000	28,90
A 55	1430	1400	11,00	A 167	4280	4250	31,10
A 56	1452	1422	12,20	A 187	4780	4750	35,40
A 57	1480	1450	12,20	A 197	5030	5000	36,70
A 58	1505	1475	12,20				
A 59	1530	1500	12,20				
A 60	1555	1525	12,20				
A 61	1580	1550	12,20				
A 62	1605	1575	12,20				
A 63	1630	1600	12,20				
A 64	1655	1625	13,20				
A 65	1680	1650	13,20				
A 66	1706	1676	13,20				
A 67	1730	1700	13,20				
A 68	1755	1725	13,20				
A 69	1780	1750	13,20				
A 70	1805	1775	13,20				
A 71	1830	1800	13,20				
A 72	1855	1825	14,50				
A 73	1884	1854	14,50				
A 74	1910	1880	14,50				
A 75	1930	1900	14,50				
A 76	1960	1930	14,50				
A 77	1986	1956	14,50				
A 78	2010	1980	14,50				
A 79	2030	2000	14,50				
A 80	2062	2032	15,40				
A 81	2090	2060	15,40				
A 82	2113	2083	15,40				
A 83	2130	2100	15,40				
A 83 1/2	2150	2120	15,40				
A 84	2164	2134	16,30				
A 84 1/2	2180	2150	16,30				
A 85	2190	2160	16,30				
A 86	2215	2185	16,30				
A 86 1/2	2230	2200	16,30				
A 87	2240	2210	16,30				
A 87 1/2	2250	2220	16,30				
A 88	2270	2240	16,30				
A 89	2290	2260	17,20				
A 90	2316	2286	17,20				
A 93	2390	2360	17,20				
A 96	2468	2438	17,20				
A 97	2494	2464	17,20				
A 98 1/2	2530	2500	17,20				
A 100	2570	2540	19,70				
A 102	2621	2591	19,70				
A 104	2680	2650	19,70				
A 105	2697	2667	19,70				
A 107	2755	2725	19,70				
A 108	2773	2743	19,70				
A 110	2830	2800	19,70				
A 112	2875	2845	22,60				
A 118	3030	3000	22,60				
A 120	3078	3048	22,60				
A 124	3180	3150	22,60				
A 128	3280	3250	25,00				
A 132	3380	3350	25,00				
A 136	3484	3454	25,00				

Gewicht/ weight = 0,112 kg/m

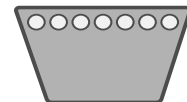

Profil / Section 17 x 11 mm B				Profil / Section 17 x 11 mm B			
Code - Nr.	Richtlänge pitch length ISO / LD mm	Innenlänge inside length mm	Stück piece Euro	Code - Nr.	Richtlänge pitch length ISO / LD mm	Innenlänge inside length mm	Stück piece Euro
B 22 1/2	610	570	9,10	B 63	1640	1600	17,70
B 24	655	615	9,10	B 64	1665	1625	19,80
B 25	670	630	9,10	B 65	1690	1650	19,80
B 25 1/2	690	650	9,10	B 66	1716	1676	19,80
B 26 1/2	710	670	9,10	B 67	1740	1700	19,80
B 27	726	686	9,10	B 68	1765	1725	20,20
B 28	750	710	9,10	B 69	1790	1750	20,20
B 28 1/2	765	725	9,10	B 69 1/2	1801	1761	20,20
B 29 1/2	790	750	9,10	B 70	1815	1775	20,20
B 30	802	762	9,10	B 71	1840	1800	20,20
B 30 1/2	815	775	9,10	B 72	1869	1829	21,30
B 31	827	787	9,10	B 73	1890	1850	21,30
B 31 1/2	840	800	9,10	B 74	1920	1880	21,30
B 32	853	813	10,40	B 75	1940	1900	21,30
B 32 1/2	865	825	10,40	B 76	1970	1930	21,30
B 33	876	836	10,40	B 77	1990	1950	21,30
B 33 1/2	890	850	10,40	B 78	2021	1981	21,30
B 34	904	864	10,40	B 79	2040	2000	21,30
B 34 1/2	915	875	10,40	B 80	2072	2032	22,80
B 35	929	889	10,40	B 81	2100	2060	22,80
B 35 1/2	940	900	10,40	B 82	2123	2083	22,80
B 36	954	914	11,20	B 83	2140	2100	22,80
B 36 1/2	965	925	11,20	B 83 1/2	2160	2120	22,80
B 37	980	940	11,20	B 84	2170	2130	25,00
B 37 1/2	990	950	11,20	B 85	2200	2160	25,00
B 38	1005	965	11,20	B 86	2225	2185	25,00
B 38 1/2	1015	975	11,20	B 86 1/2	2240	2200	25,00
B 39	1030	990	11,20	B 87	2550	2210	25,00
B 39 1/2	1040	1000	11,20	B 88	2280	2240	25,00
B 40	1056	1016	11,20	B 89	2300	2260	25,90
B 40 1/2	1070	1030	11,90	B 90	2326	2286	25,90
B 41	1080	1040	11,90	B 90 1/2	2340	2300	25,90
B 41 1/2	1090	1050	11,90	B 91	2350	2310	25,90
B 42	1100	1060	11,90	B 92	2370	2330	25,90
B 42 1/2	1115	1075	11,90	B 93	2400	2360	25,90
B 43	1130	1090	11,90	B 94	2420	2380	27,50
B 43 1/2	1140	1100	11,90	B 94 1/2	2440	2400	27,50
B 44	1160	1120	11,90	B 95	2453	2413	27,50
B 45	1190	1150	13,80	B 96	2478	2438	27,50
B 45 1/2	1203	1163	13,80	B 96 1/2	2490	2450	27,50
B 46	1215	1175	13,80	B 97	2505	2465	27,50
B 46 1/2	1220	1180	13,80	B 98	2530	2490	27,50
B 47	1230	1190	13,80	B 98 1/2	2540	2500	27,50
B 47 1/2	1240	1200	14,20	B 99	2560	2520	27,50
B 48	1255	1215	14,20	B 100	2580	2540	27,50
B 48 1/2	1265	1225	14,20	B 101	2610	2570	29,00
B 49	1290	1250	14,20	B 102	2640	2600	29,00
B 50	1315	1275	14,90	B 103	2665	2625	29,00
B 51	1340	1300	14,90	B 104	2690	2650	29,00
B 52	1360	1320	14,90	B 105	2707	2667	29,70
B 52 1/2	1375	1335	15,80	B 106	2740	2700	29,70
B 53	1390	1350	15,80	B 108	2790	2750	29,70
B 53 1/2	1400	1360	15,80	B 110	2840	2800	29,70
B 54	1412	1372	15,80	B 112	2885	2845	29,70
B 55	1440	1400	15,80	B 114	2940	2900	33,00
B 56	1462	1422	17,30	B 116	2990	2950	33,00
B 57	1490	1450	17,30	B 118	3040	3000	33,00
B 58	1513	1473	17,30	B 120	3088	3048	35,40
B 59	1540	1500	17,30	B 122	3140	3100	35,40
B 60	1565	1525	17,70	B 124	3190	3150	35,40
B 61	1590	1550	17,70	B 126	3240	3200	36,70
B 62	1615	1575	17,70	B 128	3290	3250	36,70

Gewicht/ weight = 0,198 kg/m

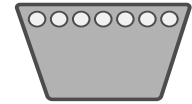

Profil / Section 17 x 11 mm B				Profil / Section 20 x 12,5 mm			
Code - Nr.	Richtlänge pitch length ISO / LD mm	Innenlänge inside length mm	Stück piece Euro	Code - Nr.	Richtlänge pitch length ISO / LD mm	Innenlänge inside length mm	Stück piece Euro
B 130	3340	3300	36,70		1000	950	13,50
B 132	3390	3350	36,70		1025	975	13,50
B 134	3440	3400	39,40		1050	1000	13,50
B 135	3470	3430	39,40		1080	1030	15,50
B 136	3490	3450	39,40		1110	1060	15,50
B 138	3540	3500	39,40		1170	1120	15,50
B 140	3590	3550	39,40		1200	1150	17,70
B 142	3640	3600	39,40		1230	1180	17,70
B 144	3698	3658	41,20		1250	1200	17,70
B 146	3740	3700	41,20		1265	1215	17,70
B 148	3790	3750	41,20		1300	1250	17,70
B 150	3850	3810	44,50		1325	1275	18,80
B 151 1/2	3890	3850	44,50		1350	1300	18,80
B 155 1/2	3990	3950	44,50		1370	1320	18,80
B 157 1/2	4040	4000	44,50		1400	1350	19,80
B 162	4155	4115	47,00		1450	1400	19,80
B 165	4240	4200	47,00		1500	1450	19,80
B 167	4290	4250	47,00		1550	1500	19,80
B 173	4435	4395	49,20		1650	1600	21,40
B 175	4490	4450	49,20		1700	1650	23,00
B 177	4540	4500	49,20		1710	1660	23,00
B 180	4612	4572	49,20		1750	1700	23,00
B 187	4790	4750	49,20		1825	1775	25,70
B 195	4993	4953	56,20		1850	1800	25,70
B 197	5040	5000	56,20		1925	1875	26,60
B 208 1/2	5340	5300	59,90		1950	1900	26,60
B 210	5374	5334	63,10		1975	1925	26,60
B 220 1/2	5640	5600	63,80		2000	1950	26,60
B 236	6040	6000	68,00		2050	2000	26,80
B 248	6340	6300	71,80		2100	2050	31,50
B 256	6590	6500	75,10		2170	2120	31,50
B 264	6740	6700	76,60		2250	2200	31,90
B 276	7040	7000	80,50		2290	2240	31,90
B 279 1/2	7140	7100	81,60		2410	2360	33,80
					2550	2500	34,20
					2650	2600	36,40
					2700	2650	36,40
					2850	2800	38,00
					3050	3000	40,40
					3200	3150	43,70
					3300	3250	45,10
					3400	3350	45,10
					3500	3450	47,40
					3600	3550	47,40
					3700	3650	50,40
					3800	3750	50,40
					4050	4000	52,80
					4300	4250	57,20
					4550	4500	61,00
					4800	4750	64,10
					5050	5000	66,90
					5350	5300	74,10
					5650	5600	75,10
					6050	6000	80,50
					6350	6300	85,30
					6750	6700	90,70
					7150	7100	95,60
					7550	7500	103,60
					8050	8000	112,20
Gewicht/ weight = 0,198 kg/m				Gewicht/ weight = 0,268 kg/m			

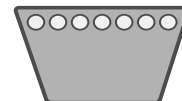

Profil / Section 22 x 14 mm C				Profil / Section 22 x 14 mm C			
Code - Nr.	Richtlänge pitch length ISO / LD mm	Innenlänge inside length mm	Stück piece Euro	Code - Nr.	Richtlänge pitch length ISO / LD mm	Innenlänge inside length mm	Stück piece Euro
C 39 1/2	1058	1000	17,60	C 146	3758	3700	57,20
C 43	1148	1090	17,60	C 148 1/2	3808	3750	57,20
C 46 1/2	1238	1180	18,40	C 157 1/2	4058	4000	61,00
C 47	1258	1200	18,40	C 161 1/2	4158	4100	61,00
C 47 1/2	1273	1215	18,40	C 167	4308	4250	66,50
C 48	1278	1220	18,40	C 173	4452	4394	66,50
C 49	1308	1250	18,40	C 177	4558	4500	69,60
C 51	1353	1295	20,10	C 180	4633	4575	72,50
C 52	1378	1320	20,10	C 187	4808	4750	72,50
C 53	1408	1350	21,20	C 195	5011	4953	76,30
C 54	1433	1375	21,20	C 197	5058	5000	76,60
C 55	1458	1400	21,20	C 208	5358	5300	84,80
C 56	1483	1425	23,20	C 210 1/2	5392	5334	85,80
C 57	1508	1450	23,20	C 220	5658	5600	94,60
C 59	1558	1500	23,20	C 225	5773	5715	98,80
C 60	1582	1524	24,40	C 236	6058	6000	106,30
C 61	1608	1550	24,40	C 240	6154	6096	107,30
C 62	1632	1574	24,40	C 248 1/2	6358	6300	109,20
C 63	1658	1600	24,40	C 264	6758	6700	116,00
C 65	1708	1650	26,20	C 270	6916	6858	118,70
C 66	1733	1675	26,20	C 279	7158	7100	131,80
C 67	1758	1700	26,20	C 295	7558	7500	144,30
C 68	1785	1727	27,30	C 315	8058	8000	155,00
C 69	1808	1750	27,30				
C 70	1836	1778	27,30				
C 71	1858	1800	27,30				
C 72	1883	1825	30,20				
C 73	1908	1850	30,20				
C 74	1933	1875	30,20				
C 75	1958	1900	30,20				
C 79	2058	2000	30,80				
C 80	2083	2025	30,80				
C 81	2118	2060	31,80				
C 83 1/2	2178	2120	33,10				
C 85	2217	2159	33,10				
C 87	2268	2210	33,70				
C 87 1/2	2278	2220	33,70				
C 88	2298	2240	33,70				
C 90	2344	2286	36,30				
C 93	2418	2360	36,30				
C 95	2478	2420	38,20				
C 96 1/2	2508	2450	38,20				
C 98 1/2	2558	2500	38,20				
C 99 1/2	2583	2525	39,60				
C 100	2598	2540	39,60				
C 101	2618	2560	39,60				
C 102	2658	2600	39,60				
C 104	2708	2650	40,70				
C 105	2725	2667	40,70				
C 108	2808	2750	40,70				
C 110	2858	2800	40,70				
C 112	2903	2845	45,10				
C 116	3008	2950	45,10				
C 117	3023	2965	45,10				
C 118	3058	3000	45,10				
C 120	3106	3048	47,10				
C 124	3208	3150	47,70				
C 128	3308	3250	50,60				
C 132	3408	3350	50,90				
C 136	3508	3450	53,60				
C 140	3608	3550	53,60				
C 144	3716	3658	57,20				

Gewicht/ weight = 0,330 kg/m

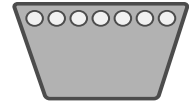

Profil / Section 25 x 16 mm				Profil / Section 32 x 20 mm D			
Code - Nr.	Richtlänge pitch length ISO / LD mm	Innenlänge inside length mm	Stück piece Euro	Code - Nr.	Richtlänge pitch length ISO / LD mm	Innenlänge inside length mm	Stück piece Euro
	1410	1350	25,60	D 79	2075	2000	71,00
	1460	1400	25,60	D 98 1/2	2575	2500	71,00
	1560	1500	28,20	D 104	2725	2650	76,40
	1660	1600	29,80	D 110	2875	2800	80,30
	1760	1700	31,30	D 118	3075	3000	86,00
	1860	1800	32,70	D 120	3123	3048	87,00
	1910	1850	34,40	D 124	3225	3150	87,90
	1960	1900	34,40	D 128	3326	3251	91,40
	2020	1950	35,40	D 132	3425	3350	94,70
	2060	2000	35,60	D 135	3500	3425	96,10
	2110	2050	37,60	D 140	3625	3550	98,10
	2180	2120	37,60	D 144	3733	3658	100,60
	2260	2200	39,60	D 148	3825	3750	101,50
	2300	2240	39,60	D 154 1/2	4000	3925	111,20
	2385	2325	40,10	D 157 1/2	4075	4000	111,20
	2420	2360	40,10	D 165 1/2	4325	4250	118,00
	2510	2450	43,80	D 173	4469	4394	123,70
	2560	2500	43,80	D 177	4575	4500	125,20
	2710	2650	47,10	D 180	4647	4572	127,20
	2760	2700	47,10	D 187	4825	4750	133,00
	2860	2800	47,10	D 195	5028	4953	138,80
	3010	2950	53,00	D 197	5075	5000	140,10
	3060	3000	53,00	D 208 1/2	5375	5300	147,50
	3210	3150	55,60	D 210	5409	5334	147,50
	3410	3350	59,90	D 220 1/2	5675	5600	165,30
	3510	3450	61,00	D 225	5790	5715	167,70
	3610	3550	62,10	D 236	6075	6000	174,90
	3810	3750	66,50	D 240	6171	6096	177,50
	4010	3950	69,60	D 248	6375	6300	182,70
	4060	4000	69,60	D 264	6775	6700	200,60
	4310	4250	74,50	D 270	6933	6858	206,00
	4510	4450	79,40	D 279 1/2	7175	7100	214,60
	4560	4500	79,40	D 295	7575	7500	237,40
	4810	4750	84,20	D 315	8075	8000	254,70
	5060	5000	90,20	D 330	8457	8382	267,30
	5360	5300	98,30	D 335	8575	8500	272,50
	5660	5600	108,00	D 354	9075	9000	296,80
	6060	6000	118,30	D 374	9575	9500	312,80
	6350	6300	125,80	D 394	10075	10000	327,70
	6560	6500	133,50	D 441	11275	11200	367,40
	6760	6700	140,50	D 492	12575	12500	408,00
	7160	7100	150,80	Gewicht/ weight = 0,675 kg/m			
	7560	7500	162,50	Profil / Section 40 x 25 mm E			
	8060	8000	172,80				
	8560	8500	188,50	E 132	3430	3350	160,00
	9060	9000	204,10	E 157 1/2	4080	4000	187,60
	9310	9250	210,60	E 197	5080	5000	229,60
	9560	9500	214,90	E 220 1/2	5680	5600	271,70
	10060	10000	229,00	E 236	6080	6000	300,10
	10460	10400	254,90	E 248	6380	6300	312,20
				E 279 1/2	7180	7100	362,10
				E 295	7580	7500	388,70
				E 315	8080	8000	413,90
				E 354	9080	9000	477,10
				E 394	10080	10000	528,90
				E 441	11280	11200	596,50
				E 492	12580	12500	661,30
Gewicht/ weight = 0,422 kg/m				Gewicht/ weight = 1,030 kg/m			

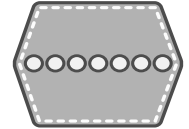

Profil / Section AA/ HAA			Profil / Section BB/ HBB			Profil / Section CC/ HCC		
Riemen-Nr. Belt No.	LM= Mittellänge middle length mm	Stück piece Euro	Riemen-Nr. Belt No.	LM= Mittellänge middle length mm	Stück piece Euro	Riemen-Nr. Belt No.	LM= Mittellänge middle length mm	Stück piece Euro
AA 51	1345	35,20	BB 53	1415	43,10	CC 75	2012	92,00
AA 60	1574	41,40	BB 54	1440	43,90	CC 81	2164	99,00
AA 61	1600	42,10	BB 74	1950	57,00	CC 85	2266	104,00
AA 64	1675	44,20	BB 75	1975	57,70	CC 86	2291	106,00
AA 68	1777	46,90	BB 77	2025	58,70	CC 90	2393	111,00
AA 69	1803	47,60	BB 81	2126	61,70	CC 94	2495	116,00
AA 70	1828	48,30	BB 83	2180	63,00	CC 96	2545	118,00
AA 71	1854	49,00	BB 84	2203	53,70	CC 105	2774	129,00
AA 75	1955	51,80	BB 85	2228	54,50	CC 106	2800	130,00
AA 76	1980	53,10	BB 88	2305	66,50	CC 112	2952	138,00
AA 77	2005	55,90	BB 90	2355	68,40	CC 120	3155	148,00
AA 80	2083	58,10	BB 92	2406	70,10	CC 122	3206	150,00
AA 81	2109	58,80	BB 93	2431	70,90	CC 126	3307	155,00
AA 85	2209	58,70	BB 95	2482	71,70	CC 128	3358	157,00
AA 88	2285	60,70	BB 96	2507	73,20	CC 144	3765	173,00
AA 90	2335	64,00	BB 97	2533	73,70	CC 149	3886	183,00
AA 91	2361	64,70	BB 99	2585	77,70	CC 153	3993	186,00
AA 92	2386	64,70	BB 101	2634	77,70	CC 158	4120	190,00
AA 93	2413	64,70	BB 105	2736	82,90	CC 162	4222	193,00
AA 95	2464	66,10	BB 107	2787	84,20	CC 165	4300	198,00
AA 96	2489	66,50	BB 109	2838	84,20	CC 173	4500	207,00
AA 98	2539	67,60	BB 110	2863	85,00	CC 180	4679	216,00
AA 100	2591	69,00	BB 112	2914	86,30	CC 193	5009	227,00
AA 102	2642	70,40	BB 115	2990	86,30	CC 195	5060	230,00
AA 103	2667	70,40	BB 116	3015	88,30	CC 204	5289	244,00
AA 105	2718	72,50	BB 118	3066	89,90	CC 206	5339	247,00
AA 108	2794	77,70	BB 120	3117	91,50	CC 210	5441	258,00
AA 112	2896	77,70	BB 121	3142	92,10	CC 224	5796	263,00
AA 116	2997	80,00	BB 125	3244	95,40	CC 234	6050	
AA 120	3096	82,80	BB 126	3270	96,60	CC 240	6203	
AA 122	3148	84,20	BB 128	3320	101,40	CC 270	6965	
AA 124	3199	85,50	BB 131	3396	103,20	CC 300	7727	auf Anfrage
AA 126	3251	86,90	BB 133	3447	104,60	CC 313	8057	on request
AA 128	3302	86,30	BB 135	3500	104,60	CC 330	8489	
AA 130	3353	89,70	BB 137	3550	104,60	CC 360	9250	
AA 134	3455	92,50	BB 144	3727	110,30	CC 390	10013	
AA 136	3505	93,80	BB 145	3752	110,30	CC 420	10775	
AA 145	3733	100,10	BB 154	3981	114,90			
AA 146	3759	100,70	BB 155	4006	115,60			
AA 152	3912	104,60	BB 156	4031	116,70			
AA 154	3962	106,30	BB 158	4082	120,40			
AA 156	4013	107,60	BB 162	4185	123,10			
AA 157	4039	108,40	BB 169	4362	128,80			
AA 158	4064	109,10	BB 173	4463	129,40			
AA 164	4219	113,20	BB 174	4489	131,60			
AA 165	4242	113,90	BB 180	4641	134,90			
AA 166	4267	114,50	BB 182	4692	136,40			
AA 176	4521	121,40	BB 184	4743	137,90			
AA 178	4572	122,80	BB 194	4997	146,40			
AA 185	4750	127,70	BB 195	5022	148,60			
AA 189	4851	130,40	BB 210	5403	160,10			
AA 195	5004	134,60	BB 221	5682	163,40			
			BB 240	6165	182,90			
			BB 270	6927	205,80			
			BB 300	7690	228,70			
Gewicht/ weight = 0,150 kg/m			Gewicht/ weight = 0,250 kg/m			Gewicht/ weight = 0,440 kg/m		



XPZ			AVX 10/ 9,5			AVX 11,2 XDA 11,3 *		
LW/LD= Richtlänge pitch length mm	LA= Außenlänge outside length mm	Stück piece Euro	LW/LD= Richtlänge pitch length mm	LA= Außenlänge outside length mm	Stück piece Euro		LA= Außenlänge outside length mm	Stück piece Euro
562	575	6,00	1337	1350	11,00		11,2 x 820	9,20
587	600	6,00	1362	1375	11,00		11,2 x 866	9,20
602	615	6,00	1387	1400	11,20		11,2 x 886	9,20
612	625	6,00	1400	1413	11,20		11,3 x 912	9,20
630	643	6,00	1412	1425	11,20			
637	650	6,00	1437	1450	11,60	*XDA = extra dehnungsarm extra low stretch		
662	675	6,30	1462	1475	11,60			
670	685	6,30	1487	1500	11,90			
687	700	6,30	1500	1513	11,90			
710	725	6,30	1512	1525	11,90			
722	735	6,30	1537	1550	12,40			
737	750	6,30	1562	1575	12,40	AVX 11,5		
750	763	6,80	1587	1600	12,40		LA= Außenlänge outside length mm	Stück piece Euro
762	775	6,80	1600	1613	12,70		685	9,20
772	785	6,80	1612	1625	12,70		730	9,20
787	800	6,80	1637	1650	12,70		755	9,20
800	813	6,80	1662	1675	14,20		790	9,20
812	825	6,80	1687	1700	14,20	AVX 11,9		
825	838	7,00	1700	1713	14,20			
837	850	7,00	1737	1750	14,70			
850	864	7,00	1800	1813	14,70			
857	870	7,10	1887	1900	15,50			
862	875	7,10	1900	1913	15,50		LA= Außenlänge outside length mm	Stück piece Euro
875	888	7,10	1937	1950	16,40		650	9,20
887	900	7,10	2000	2013	16,40		710	9,20
892	905	7,50	2120	2133	18,10		740	9,20
900	913	7,50	2240	2253	19,70		768	9,20
912	925	7,70	2360	2373	20,30		775	9,20
917	930	7,70	2500	2513	22,50		793	9,20
922	935	7,70	2650	2663	22,80		806	9,20
925	940	7,70	2800	2813	24,70		864	9,90
937	950	8,00	3000	3013	25,70		876	9,90
947	960	8,00	3150	3163	27,20		950	9,90
950	965	8,00	3350	3363	28,50		965	9,90
957	970	8,00	3550	3563	30,20		982	9,90
962	975	8,30					1010	9,90
967	980	8,30					1042	9,90
977	990	8,30					1150	11,60
987	1000	8,30					1171	11,60
990	1003/5	8,30					1183	11,60
1000	1013	8,30					1214	11,60
1012	1025	8,80						
1037	1050	8,80						
1060	1075	8,80						
1077	1090	8,80						
1087	1100	8,80						
1112	1125	8,80						
1120	1133	10,20						
1137	1150	10,20						
1152	1165	10,20						
1162	1175	10,20						
1180	1193	10,20						
1187	1200	10,20						
1202	1215	10,40						
1212	1225	10,40						
1237	1250	10,40						
1250	1263	10,80						
1262	1275	10,80						
1287	1300	10,80						
1312	1325	10,80						
1320	1333	11,00						
1327	1340	11,00						
Gewicht/ weight = 0,065 kg/m						Gewicht/ weight = 0,106 kg/m		



Hochleistungs - Schmalkeilriemen Rex - flankenoffen, formgezahnt High Capacity Narrow V-Belts Rex - raw edge, moulded cogged

XPA			AVX 13/ 12,5			XPB			Profil/Section		
LW/LD= Richtlänge pitch length mm	LA= Außenlänge outside length mm	Stück piece Euro	LW/LD= Richtlänge pitch length mm	LA= Außenlänge outside length mm	Stück piece Euro	LW/LD= Richtlänge pitch length mm	LA= Außenlänge outside length mm	Stück piece Euro			
657	675	8,60	1832	1850	21,00	1250	1272	21,10			
682	700	8,60	1857	1875	21,10	1320	1342	21,50			
707	725	8,60	1882	1900	21,20	1400	1422	23,20			
732	750	8,60	1900	1918	21,40	1500	1522	24,80			
757	775	8,60	1907	1925	21,40	1600	1622	26,40			
782	800	8,60	1932	1950	21,70	1700	1722	28,20			
800	818	9,80	1957	1975	21,90	1800	1822	29,70			
807	825	9,80	1982	2000	22,20	1900	1922	31,60			
832	850	9,80	2000	2018	22,40	2000	2022	35,40			
850	868	10,20	2007	2025	22,50	2120	2142	37,40			
857	875	10,20	2032	2050	22,90	2240	2262	40,00			
882	900	10,20	2057	2075	23,00	2360	2382	41,50			
900	918	10,60	2082	2100	23,20	2500	2522	44,20			
907	925	10,60	2120	2138	23,60	2650	2672	46,90			
932	950	10,80	2182	2200	24,90	2800	2822	49,50			
950	968	11,20	2232	2250	25,20	2900	2922	51,10			
957	975	11,20	2240	2258	26,70	3000	3022	52,90			
982	1000	11,40	2307	2325	26,90	3150	3172	54,30			
1000	1018	11,40	2360	2378	27,60	3350	3372	58,00			
1007	1025	11,40	2382	2400	27,60	3550	3572	61,90			
1012	1030	11,40	2432	2450	28,20	3750	3772	65,40			
1032	1050	12,10	2482	2500	29,40	4000	4022	69,60			
1042	1060	12,10	2500	2518	29,40	4250	4272	74,10			
1060	1075	12,20	2650	2668	31,70	4500	4522	78,30			
1082	1100	12,20	2800	2818	33,50	4750	4772	82,80			
1107	1125	12,50	3000	3018	35,30	5000	5022	87,00			
1120	1138	12,50	3150	3168	37,20	Gewicht/ weight = 0,183 kg/m					
1132	1150	12,80	3350	3368	39,50						
1157	1175	12,80	3550	3568	42,80						
1180	1200	12,80	3750	3768	45,10						
1207	1225	13,80	4000	4018	48,20	XPC	Profil/Section				
1232	1250	13,80				LW/LD= Richtlänge pitch length mm	LA= Außenlänge outside length mm	Stück piece Euro			
1250	1268	14,20				2000	2030	56,40			
1257	1275	14,20				2120	2150	59,10			
1282	1300	14,60				2240	2270	62,50			
1307	1325	14,90				2360	2390	66,20			
1320	1338	15,30				2500	2530	70,00			
1332	1350	15,30				2650	2680	74,40			
1357	1375	15,80				2800	2830	77,70			
1382	1400	16,20				3000	3030	83,50			
1400	1418	16,20				3150	3180	84,70			
1407	1425	16,70				3350	3380	88,50			
1432	1450	16,70				3550	3580	93,40			
1457	1475	16,90				3750	3780	98,60			
1482	1500	17,50				4000	4030	104,90			
1500	1518	18,10				4250	4280	111,70			
1507	1525	18,10				4500	4530	118,00			
1532	1550	18,80				4750	4780	124,70			
1557	1575	19,00				5000	5030	131,40			
1582	1600	19,20									
1600	1618	19,60									
1607	1625	19,60									
1632	1650	19,70									
1657	1675	19,90									
1682	1700	20,20									
1700	1718	20,40									
1707	1725	20,40									
1732	1750	20,50									
1757	1775	20,60									
1782	1800	20,70									
1800	1818	21,00									
1807	1825	21,00									
Gewicht/ weight = 0,111 kg/m						Gewicht/ weight = 0,340 kg/m					

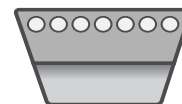

Profil/Section X/ 10 x 6 mm ZX				Profil/Section X/ 13 x 8 mm AX				Profil/Section X/ 13 x 8 mm AX			
Code Nr.	Richtlänge LD	Innenlänge inside length	Stück piece	Code Nr.	Richtlänge LD	Innenlänge inside length	Stück piece	Code Nr.	Richtlänge LD	Innenlänge inside length	Stück piece
	mm	mm	Euro		mm	mm	Euro		mm	mm	Euro
ZX 19	502	480	–	AX 22	590	560	9,20	AX 57	1480	1450	21,50
ZX 19 1/2	522	500	–	AX 23	615	585	9,20	AX 58	1505	1475	21,50
ZX 20 1/3	537	515	–	AX 23 1/2	630	600	9,20	AX 59	1530	1500	21,50
ZX 20 3/4	547	525	–	AX 24	640	610	10,10	AX 60	1555	1525	21,50
ZX 22	582	560	–	AX 24 1/2	660	630	10,10	AX 61	1580	1550	21,50
ZX 22 1/2	597	575	–	AX 25	665	635	10,10	AX 62	1605	1575	21,50
ZX 23 1/4	612	590	–	AX 25 1/2	680	650	10,10	AX 63	1630	1600	21,50
ZX 24	622	600	–	AX 26	690	660	10,10	AX 64	1655	1625	–
ZX 24 1/4	637	615	–	AX 26 1/2	700	670	10,10	AX 65	1680	1650	–
ZX 25	652	630	–	AX 27	716	686	10,10	AX 66	1706	1676	–
ZX 25 1/2	672	650	–	AX 27 1/2	730	700	10,10	AX 67	1730	1700	–
ZX 26	682	660	–	AX 28	740	710	10,60	AX 68	1755	1725	–
ZX 26 1/2	692	670	–	AX 29	760	730	10,60	AX 69	1780	1750	–
ZX 26 3/4	702	680	–	AX 29 1/2	780	750	10,60	AX 70	1805	1775	–
ZX 28	732	710	–	AX 30	797	767	10,60	AX 71	1830	1800	–
ZX 28 1/2	747	725	–	AX 30 1/2	805	775	10,60	AX 72	1855	1825	–
ZX 29	752	730	–	AX 31	817	787	10,60	AX 73	1884	1854	–
ZX 29 1/2	772	750	–	AX 31 1/2	830	800	10,60	AX 74	1910	1880	–
ZX 30	787	765	–	AX 32	843	813	12,60	AX 75	1930	1900	–
ZX 30 1/2	797	775	–	AX 32 1/2	855	825	12,60	AX 76	1960	1930	–
ZX 31	812	790	–	AX 33	871	841	12,60	AX 77	1986	1956	–
ZX 31 1/2	822	800	–	AX 33 1/2	880	850	12,60	AX 78	2010	1980	–
ZX 32	842	820	–	AX 34	893	863	12,60	AX 79	2030	2000	–
ZX 32 1/2	847	825	–	AX 34 1/2	905	875	12,60	AX 80	2062	2032	–
ZX 33	862	840	–	AX 35	919	889	12,60	AX 81	2090	2060	–
ZX 33 1/2	872	850	–	AX 35 1/2	930	900	12,60	AX 82	2113	2083	–
ZX 34	887	865	–	AX 36	944	914	13,50	AX 83	2130	2100	–
ZX 34 1/2	897	875	–	AX 36 1/2	955	925	13,50	AX 83 1/2	2150	2120	–
ZX 35 1/2	922	900	–	AX 37	970	940	13,50	AX 84	2164	2134	–
ZX 36 1/2	947	925	–	AX 37 1/2	980	950	13,50	AX 84 1/2	2180	2150	–
ZX 37	962	940	–	AX 38	995	965	13,50	AX 85	2190	2160	–
ZX 37 1/2	972	950	–	AX 38 1/2	1005	975	13,50	AX 86	2215	2185	–
ZX 38 1/2	997	975	–	AX 39	1020	990	13,50				
ZX 39 1/2	1022	1000	–	AX 39 1/2	1030	1000	13,50				
ZX 40	1038	1016	–	AX 40	1040	1016	13,50				
ZX 40 1/2	1052	1030	–	AX 40 1/2	1060	1030	13,50				
ZX 41	1063	1041	–	AX 41	1071	1041	13,50				
ZX 41 1/2	1072	1050	–	AX 41 1/2	1080	1050	13,50				
ZX 42	1082	1060	–	AX 42	1090	1060	13,50				
ZX 42 1/2	1102	1080	–	AX 42 1/2	1105	1075	13,50				
ZX 43	1122	1100	–	AX 43	1120	1090	14,60				
ZX 43 1/2	1127	1105	–	AX 43	1130	1100	14,60				
ZX 44	1142	1120	–	AX 43 1/2	1135	1105	14,60				
ZX 44 1/2	1154	1132	–	AX 44	1150	1120	14,60				
ZX 45	1172	1150	–	AX 45	1173	1143	14,60				
ZX 46	1187	1165	–	AX 45 1/2	1180	1150	14,60				
ZX 46 1/2	1202	1180	–	AX 46	1198	1168	14,60				
ZX 47	1216	1200	–	AX 46 1/2	1210	1180	14,60				
ZX 47 1/2	1237	1215	–	AX 47	1220	1190	14,60				
ZX 48 1/2	1247	1225	–	AX 47 1/2	1230	1200	14,60				
ZX 49	1272	1250	–	AX 48	1245	1215	18,50				
ZX 51	1317	1295	–	AX 48 1/4	1255	1225	18,50				
ZX 51 1/4	1322	1300	–	AX 48 3/4	1270	1240	18,50				
				AX 49	1280	1250	18,50				
				AX 50	1300	1270	18,50				
				AX 51	1330	1300	18,50				
				AX 52	1350	1320	20,10				
				AX 53	1380	1350	20,10				
				AX 54	1405	1375	20,10				
				AX 55	1430	1400	20,10				
				AX 56	1452	1422	20,10				

Nicht aufgeführte Preise und Größen auf Anfrage.

Not mentioned prices and sizes on request.

Gewicht/ weight = 0,062 kg/m

Gewicht/ weight = 0,099 kg/m

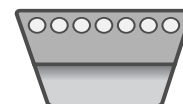

Klassische Keilriemen Rex - flankenoffen, formgezahnt Classical V-Belts Rex - raw edge, moulded cogged

Profil/Section X/17 x 11 mm BX				Profil/Section X/17 x 11 mm BX				Profil/Section X/17 x 11 mm BX			
Code Nr.	Richtlänge LD	Innenlänge inside length	Stück piece	Code Nr.	Richtlänge LD	Innenlänge inside length	Stück piece	Code Nr.	Richtlänge LD	Innenlänge inside length	Stück piece
	mm	mm	Euro		mm	mm	Euro		mm	mm	Euro
BX 22 1/2	610	570	-	BX 64	1665	1625	32,00	BX 136	3490	3450	-
BX 24	655	615	-	BX 65	1690	1650	32,00	BX 140	3590	3550	-
BX 25	670	630	12,60	BX 66	1716	1676	32,00				
BX 25 1/2	690	650	12,60	BX 67	1740	1700	32,00				
BX 26 1/2	710	670	12,60	BX 68	1765	1725	32,70				
BX 27	726	686	12,60	BX 69	1790	1750	32,70				
BX 28	750	710	12,60	BX 69 1/2	1801	1761	32,70				
BX 28 1/2	765	725	12,60	BX 70	1815	1775	32,70				
BX 29 1/2	790	750	13,60	BX 71	1840	1800	32,70				
BX 30	802	762	13,60	BX 72	1869	1829	34,70				
BX 30 1/2	815	775	13,60	BX 73	1890	1850	34,70				
BX 31	827	787	13,60	BX 74	1920	1880	34,70				
BX 31 1/2	840	800	13,60	BX 75	1940	1900	34,70				
BX 32	853	813	16,80	BX 76	1970	1930	34,70				
BX 32 1/2	865	825	16,80	BX 77	1990	1950	34,70				
BX 33	876	836	16,80	BX 78	2021	1981	34,70				
BX 33 1/2	890	850	16,80	BX 79	2040	2000	34,70				
BX 34	904	864	16,80	BX 80	2072	2032	35,10				
BX 34 1/2	915	875	16,80	BX 81	2100	2060	35,10				
BX 35	929	889	16,80	BX 82	2123	2083	35,10				
BX 35 1/2	940	900	16,80	BX 83	2140	2100	35,10				
BX 36	954	914	16,80	BX 83 1/2	2160	2120	35,10				
BX 36 1/2	965	925	16,80	BX 84	2170	2130	40,60				
BX 37	980	940	16,80	BX 85	2200	2160	40,60				
BX 37 1/2	990	950	16,80	BX 86	2225	2185	40,60				
BX 38	1005	965	16,80	BX 86 1/2	2240	2200	40,60				
BX 38 1/2	1015	975	16,80	BX 87	2250	2210	40,60				
BX 39	1030	990	16,80	BX 87 1/2	2260	2220	40,60				
BX 39 1/2	1040	1000	19,00	BX 88	2280	2240	40,60				
BX 40	1056	1016	19,00	BX 89	2300	2260	41,90				
BX 40 1/2	1070	1030	19,00	BX 90	2326	2286	41,90				
BX 41	1080	1040	19,00	BX 90 1/2	2340	2300	41,90				
BX 41 1/2	1090	1050	19,30	BX 91	2350	2310	41,90				
BX 42	1100	1060	19,30	BX 92	2370	2330	41,90				
BX 42 1/2	1115	1075	19,30	BX 93	2400	2360	41,90				
BX 43	1130	1090	19,30	BX 94	2420	2380	44,60				
BX 43 1/2	1140	1100	19,30	BX 95	2453	2413	44,60				
BX 44	1160	1120	19,30	BX 96	2478	2438	44,60				
BX 45	1190	1150	22,00	BX 96 1/2	2490	2450	44,60				
BX 45 1/2	1203	1163	22,00	BX 97	2505	2465	44,60				
BX 46	1215	1175	22,00	BX 98	2530	2490	44,60				
BX 46 1/2	1220	1180	22,00	BX 98 1/2	2540	2500	44,60				
BX 47	1230	1190	22,00	BX 99	2560	2520	44,60				
BX 47 1/2	1240	1200	22,00	BX 100	2580	2540	44,60				
BX 48	1255	1215	25,40	BX 101	2610	2570	-				
BX 48 1/2	1265	1225	25,40	BX 102	2640	2600	-				
BX 49	1290	1250	25,40	BX 103	2665	2625	-				
BX 50	1315	1275	25,40	BX 104	2690	2650	-				
BX 51	1340	1300	27,70	BX 105	2707	2667	-				
BX 52	1360	1320	27,70	BX 106	2740	2700	-				
BX 53	1390	1350	27,70	BX 108	2790	2750	-				
BX 54	1412	1372	27,70	BX 110	2840	2800	-				
BX 55	1440	1400	27,70	BX 112	2885	2845	-				
BX 56	1462	1422	27,70	BX 114	2940	2900	-				
BX 57	1490	1450	27,70	BX 116	2990	2950	-				
BX 58	1513	1473	29,10	BX 118	3040	3000	-				
BX 59	1540	1500	29,10	BX 120	3088	3048	-				
BX 60	1565	1525	29,10	BX 124	3190	3150	-				
BX 61	1590	1550	29,10	BX 128	3290	3250	-				
BX 62	1615	1575	29,10	BX 132	3390	3350	-				
BX 63	1640	1600	29,10	BX 135	3470	3430	-				

Gewicht/ weight = 0,165 kg/m



Profil section	Li mm	Winkel angle	Iso-Code Nr.	Stück / piece Euro	Profil section	Li mm	Winkel angle	Iso-Code Nr.	Stück / piece Euro																						
13 x 5	468	24		17,70	26 x 8	1562		W 25/ 1600	64,90																						
	476			18,00					28 x 8	600	25	40,10																			
	1120			25,00								650	40,70																		
17 x 5	426	24	W 16/ 450	22,20	700				41,80																						
	476			W 16/ 500	22,40	750				43,00																					
	536			W 16/ 560	23,10	800				44,10																					
21 x 6	606	27	W 16/ 630	25,40	30 x 10	650	27		43,00																						
	686			W 16/ 710					26,30	665				43,60																	
	776			W 16/ 800					28,00	680				43,80																	
	875			W 16/ 900					29,50	700				44,10																	
	976			W 16/ 1000					31,00	775				45,30																	
	530			W 20/ 560					28,00	800				46,80																	
600	W 20/ 630	29,50	850				49,10																								
22 x 8	675	25		32,70	32 x 10	750	27	W 31,5/ 800	46,40																						
	770			W 20/ 800					33,70	790				47,60																	
	870			W 20/ 900					35,60	820				49,20																	
	970			W 20/ 1000					37,00	850				50,20																	
	1090			W 20/ 1120					41,70	900				51,80																	
	525								31,80	950				53,40																	
	550								31,80	1000				55,20																	
	575								33,20	1060				56,80																	
	600								33,20	1120				58,50																	
	610								33,20	1180				60,60																	
650		34,80	1250				61,00																								
675		34,80	1320				61,30																								
700		36,30	1400				61,50																								
750		36,80	1500				61,50																								
800		38,70	1600				64,70																								
850		39,90	1700				64,70																								
900		40,70	1800				64,70																								
950		41,70	2000				64,70																								
1000		42,50	813				46,30																								
23 x 10	833	30		47,40	26 x 8		27	W 25/ 670	40,30																						
	865			49,20					655	W 25/ 695	40,70																				
				46,30					672	W 25/ 710	41,30																				
				47,40					680	W 25/ 720	41,40																				
				49,20					710	W 25/ 750	42,30																				
26 x 8	750	27	W 25/ 790	43,00	30 x 14	1140	30		60,60																						
	762			W 25/ 800					43,20	1720				89,80																	
	800			W 25/ 840					44,10					36 x 14	1140	30															
	850			W 25/ 890					46,40											36 x 14	1720	30									
	862			W 25/ 900					46,50																	36 x 14	1720	30			
	900			W 25/ 940					47,40																						
962	W 25/ 1000	49,00	36 x 14	1720	30																										
1000	W 25/ 1040	50,20																													
1082	W 25/ 1120	52,10																													
1212	W 25/ 1250	55,90																													
1362	W 25/ 1400	59,00																													

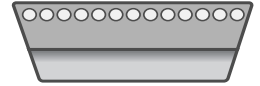

Profil section	Li mm	Winkel angle	Iso-Code Nr.	Stück /piece Euro	Profil section	Li mm	Winkel angle	Iso-Code Nr.	Stück / piece Euro						
37 x 10	750	28		52,80	52 x 16	2425	28		210,60						
	800			54,60		55 x 16			1250	123,70					
	850			56,80					1320	126,40					
	900			58,50					1400	129,90					
	950			60,60					1500	138,90					
	1000			62,20					1600	145,00					
	1060			63,90		1700			150,80						
	1120			66,50		1800			153,80						
	1180			69,30		1900			157,30						
	1250			71,90		65 x 20			1706	30	W 63/ 1800	249,70			
	1320			74,20					1906	W 63/ 2000	269,80				
	1400			78,40					2146	W 63/ 2240	321,30				
	1500			81,70		2406			357,30						
	1600			84,90		70 x 18			1445	28		227,40			
	1700			89,80					1500	235,80					
				1800								93,00		1550	243,80
				2000								97,90		1600	251,80
				2240								106,10		1700	257,20
2500		116,30	1800	265,50											
41 x 13		925	27	W 40/ 990	73,50		2000					285,40			
		970		W 40/ 1030	76,10		2240					316,60			
	1000	W 40/ 1060		77,90	2500		346,40								
	1040	W 40/ 1100		80,10	2800		364,00								
	1060	W 40/ 1120		81,70	3150		409,60								
		1120			W 40/ 1180		83,30								
1190		W 40/ 1250	86,60												
1250		W 40/ 1310	89,80												
1340		W 40/ 1400	94,60												
1400		W 40/ 1460	96,80												
		1440			W 40/ 1500	98,50									
	1600	W 40/ 1660		106,60											
	1740	W 40/ 1800		113,10											
	1940	W 40/ 2000		120,10											
	2180	W 40/ 2240		126,50											
	47 x 13	850		28		78,90									
900		78,90													
950		80,10													
1000		82,20													
1060		85,50													
	1120			89,30											
	1180			91,40											
	1250			94,60											
	1320			97,40											
	1400			107,40											
	1500			108,70											
	1600			113,10											
	1700			118,40											
	1800			121,80											
	2000			129,90											
	2240			136,90											
	2500			149,80											
52 x 16	1180	27	W 50/ 1255	116,20											
	1250		W 50/ 1325	120,80											
	1325		W 50/ 1400	126,80											
	1400		W 50/ 1475	132,20											
	1525		W 50/ 1600	142,70											
	1600		W 50/ 1675	148,20											
	1725		W 50/ 1800	154,60											
	1800		W 50/ 1875	157,80											
	1900		165,50												
	1925		W 50/ 2000	165,50											
	2000		W 50/ 2075	170,70											
	2165		W 50/ 2240	181,00											

Viele weitere Längen und Breiten am Lager.

Many other lengths and widths at stock.

Aufpreis für geschnittene Sonderbreiten: 20 %

Surcharge for cutting special widths: 20 %

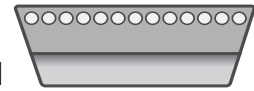

RMA - MPTA Code Nr.	Stück / piece Euro	RMA - MPTA Code Nr.	Stück / piece Euro	RMA - MPTA Code Nr.	Stück / piece Euro
1422 V 235		2322 V 521		3432 V 534	
1422 V 240		2322 V 541		4430 V 530	
1422 V 270		2322 V 601		4430 V 548	
1422 V 290		2322 V 661		4430 V 555	
1422 V 300		2322 V 681		4430 V 560	
1422 V 330		2322 V 701		4430 V 570	
1422 V 340		2322 V 801		4430 V 578	
1422 V 360		2530 V 500		4430 V 600	
1422 V 400		2530 V 530		4430 V 610	
1422 V 420		2530 V 560		4430 V 630	
1422 V 440		2530 V 600		4430 V 652	
1422 V 460		2530 V 630		4430 V 660	
1422 V 470		2530 V 670		4430 V 670	
1422 V 480		2530 V 710		4430 V 690	
1422 V 540		2530 V 750		4430 V 700	
1422 V 600		2530 V 790		4430 V 710	
1422 V 660		2830 V 337		4430 V 730	
1430 V 215		2830 V 363		4430 V 750	
1922 V 277		2830 V 366		4430 V 790	
1922 V 282		2830 V 367		4430 V 800	
1922 V 298		2830 V 393		4430 V 850	
1922 V 321		2830 V 396			
1922 V 332		2830 V 422			
1922 V 338		2926 V 471			
1922 V 363		2926 V 486			
1922 V 381	auf Anfrage on request	2926 V 521	auf Anfrage on request		auf Anfrage on request
1922 V 386		2926 V 546			
1922 V 403		2926 V 574			
1922 V 426		2926 V 586			
1922 V 443		2926 V 606			
1922 V 454		2926 V 616			
1922 V 460		2926 V 636			
1922 V 484		2926 V 646			
1922 V 526		2926 V 666			
1922 V 544		2926 V 686			
1922 V 604		2926 V 726			
1922 V 630		2926 V 750			
1922 V 646		2926 V 776			
1922 V 666		2926 V 786			
1922 V 686		3226 V 392			
1922 V 706		3226 V 400			
1922 V 721		3226 V 433			
1922 V 726		3226 V 450			
1922 V 751		3226 V 505			
1922 V 756		3226 V 545			
1926 V 250		3226 V 585			
1926 V 275		3226 V 603			
1926 V 290		3226 V 650			
1926 V 407		3226 V 663			
1926 V 415		3226 V 723			
1926 V 427		3226 V 783			
2230 V 266		3226 V 843			
2230 V 273		3230 V 560			
2230 V 275		3230 V 585			
2230 V 326		3230 V 600			
2230 V 375		3230 V 630			
2322 V 329		3230 V 670			
2322 V 347		3230 V 710			
2322 V 364		3230 V 723			
2322 V 396		3230 V 750			
2322 V 421		3230 V 800			
2322 V 434		3230 V 850			
2322 V 441		3432 V 450			
2322 V 461		3432 V 456			
2322 V 481		3432 V 480			
2322 V 486		3432 V 528			

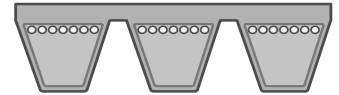

Profil/ Section 3V/ 9 J			Profil/ Section 8 V/ 25J			Profil/ Section SPB		
Type	Außenlänge outside length mm	Rippe rib Euro	Type	Außenlänge outside length mm	Rippe rib Euro	Richtlänge pitch length mm	Rippe rib Euro	
3V 450	9J 1143	21,30	8V 1000	25J 2540	159,80	2000	75,30	
3V 500	9J 1270	23,70	8V 1060	25J 2692	167,10	2120	79,80	
3V 530	9J 1346	25,40	8V 1120	25J 2845	176,60	2240	83,10	
3V 560	9J 1422	26,00	8V 1180	25J 2997	186,40	2360	84,90	
3V 600	9J 1524	26,60	8V 1250	25J 3175	196,10	2500	86,80	
3V 630	9J 1600	27,30	8V 1320	25J 3353	205,60	2650	91,20	
3V 670	9J 1702	27,80	8V 1400	25J 3556	219,00	2800	95,50	
3V 710	9J 1803	29,00	8V 1500	25J 3810	233,20	3000	100,00	
3V 750	9J 1905	30,80	8V 1600	25J 4064	246,40	3150	102,80	
3V 800	9J 2032	33,80	8V 1700	25J 4318	264,80	3350	110,70	
3V 850	9J 2159	36,30	8V 1800	25J 4572	280,50	3550	114,30	
3V 900	9J 2286	37,40	8V 1900	25J 4826	297,40	3750	122,10	
3V 950	9J 2413	38,10	8V 2000	25J 5080	310,70	4000	131,80	
3V 1000	9J 2540	38,70	8V 2120	25J 5385	334,60	4250	137,70	
3V 1060	9J 2692	42,30	8V 2240	25J 5690	351,60	4500	150,00	
3V 1120	9J 2845	46,80	8V 2360	25J 5994	368,60	4750	157,40	
3V 1180	9J 2997	48,70	8V 2500	25J 6350	389,20	5000	163,50	
3V 1250	9J 3175	49,50	8V 2650	25J 6731	412,20	5300	175,30	
3V 1320	9J 3353	50,50	8V 2800	25J 7112	438,80	5600	185,00	
3V 1400	9J 3556	54,50	8V 3000	25J 7620	467,60	6000	196,90	
			8V 3150	25J 8001	492,90	6300	207,90	
			8V 3350	25J 8509	524,70	6700	222,70	
			8V 3550	25J 9017	557,30	7100	233,20	
			8V 3750	25J 9525	588,40	7500	250,20	
			8V 4000	25J 10160	626,00	8000	259,80	
Profil/ Section 5 V/ 15 J			8V 4250	25J 10795	667,00			
Type	Außenlänge outside length mm	Rippe rib Euro	8V 4500	25J 11430	711,40			
			8V 4750	25J 12065	752,80			
5V 530	15J 1346	49,50						
5V 560	15J 1422	52,80				Profil/ Section SPC		
5V 600	15J 1524	56,40				Richtlänge pitch length mm	Rippe rib Euro	
5V 630	15J 1600	60,20				3000	151,00	
5V 670	15J 1702	64,30				3150	152,30	
5V 710	15J 1803	66,00				3350	157,40	
5V 750	15J 1905	70,20				3550	165,70	
5V 800	15J 2032	75,70				3750	173,90	
5V 850	15J 2159	79,80				4000	188,60	
5V 900	15J 2286	83,10				4250	198,20	
5V 950	15J 2413	84,90				4500	207,90	
5V 1000	15J 2540	86,80				4750	227,10	
5V 1060	15J 2692	91,20				5000	235,80	
5V 1120	15J 2845	95,50				5300	255,30	
5V 1180	15J 2997	100,00				5600	282,80	
5V 1250	15J 3175	102,80				6000	299,70	
5V 1320	15J 3353	110,70				6300	314,50	
5V 1400	15J 3556	118,00				6700	332,30	
5V 1500	15J 3810	122,10				7100	357,50	
5V 1600	15J 4064	131,80				7500	384,20	
5V 1700	15J 4318	137,70				8000	407,10	
5V 1800	15J 4572	151,00				8500	429,10	
5V 1900	15J 4826	158,40				9000	458,10	
5V 2000	15J 5080	165,70				9500	481,00	
5V 2120	15J 5385	176,60				10000	500,20	
5V 2240	15J 5690	186,40				10600	534,30	
5V 2360	15J 5994	196,90				11200	565,50	
5V 2500	15J 6350	207,90				11800	594,40	
5V 2650	15J 6731	222,70				12500	629,80	
5V 2800	15J 7112	233,20						
5V 3000	15J 7620	252,40						
5V 3150	15J 8001	259,80	Weitere Abmessungen auf Anfrage. Further dimensions on request.					
5V 3350	15J 8509	278,20						
5V 3550	15J 9017	295,10						

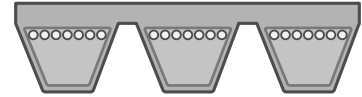

Profil/ Section A/ HA				Profil/ Section C/ HC			
Profil / Section A Innenlänge inside length		Profil / Section HA Außenlänge outside length	Rippe rib	Profil / Section C Innenlänge inside length		Profil / Section HC Außenlänge outside length	Rippe rib
Nr./ No.	mm	mm	Euro	Nr./ No.	mm	mm	Euro
47	1200	1236	23,70	90	2286	2361	84,10
51	1300	1336	24,80	98	2500	2575	89,60
56	1422	1458	25,60	108	2750	2825	97,90
57	1450	1486	26,10	120	3048	3123	106,60
59	1500	1536	26,10	128	3250	3325	114,90
64	1625	1661	27,80	140	3550	3625	125,90
67	1700	1736	29,10	146	3700	3775	129,60
71	1800	1836	29,70	151	3850	3925	143,00
75	1900	1936	32,00	167	4250	4325	152,60
79	2000	2036	35,10	177	4500	4575	157,60
88	2240	2276	37,60	187	4750	4825	171,00
98	2500	2536	40,50	197	5000	5075	177,10
100	2540	2576	40,80	208	5300	5375	186,60
104	2650	2686	41,20	220	5600	5675	198,60
112	2845	2881	47,80	236	6000	6075	209,50
120	3048	3084	49,70	248	6300	6375	219,30
128	3250	3286	52,80				
144	3658	3694	58,90				
158	4000	4036	64,30				
167	4250	4286	67,60				
187	4750	4786	75,60				
Profil/ Section B/ HB				Profil/ Section D/ HD			
Profil / Section B Innenlänge inside length		Profil / Section HB Außenlänge outside length	Rippe rib	Profil / Section D Innenlänge inside length		Profil / Section HD Außenlänge outside length	Rippe rib
Nr./ No.	mm	mm	Euro	Nr./ No.	mm	mm	Euro
47	1200	1262	27,80	98	2500	2611	146,60
51	1300	1362	29,10	110	2800	2911	162,30
55	1400	1462	29,70	120	3048	3159	177,80
59	1500	1562	30,20	128	3250	3361	188,90
61	1550	1612	31,20	144	3658	3769	213,20
63	1600	1662	32,00	158	4000	4111	235,00
64	1625	1687	33,20	162	4115	4226	244,50
67	1700	1762	35,10	173	4394	4505	255,60
71	1800	1862	35,60	180	4572	4683	268,90
73	1850	1912	36,30	195	4953	5064	286,90
75	1900	1962	36,30	210	5334	5445	309,80
79	2000	2062	38,80	225	5715	5826	329,10
83	2100	2162	40,50	240	6096	6207	349,90
88	2240	2302	41,70	255	6477	6588	371,40
91	2300	2362	43,00	270	6858	6969	392,10
94 1/2	2400	2462	47,80	285	7239	7350	413,80
98	2500	2562	49,70	300	7620	7731	432,10
102	2600	2662	50,50	315	8000	8111	457,40
106	2700	2762	52,40	330	8382	8493	479,50
112	2845	2907	54,60	345	8763	8874	501,10
118	3000	3062	57,80	360	9144	9255	521,60
120	3048	3110	58,90	390	9906	10017	566,30
128	3250	3312	61,20	420	10668	10779	609,90
132	3350	3412	64,90	450	11430	11541	656,00
140	3550	3612	67,60	480	12200	12311	701,90
146	3700	3762	70,30	Verfügbarkeit auf Anfrage. Availability on request.			
148	3750	3812	71,70				
158	4000	4062	75,90				
167	4250	4312	79,00				
177	4500	4562	85,90				
187	4750	4812	90,60				
197	5000	5062	93,40				
208	5300	5362	101,10				
220	5600	5662	103,40				

ConCar

Endliche Lochkeilriemen DIN 2216, grün
Open ended V - Belting DIN 2216, punched, green

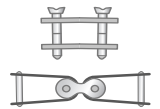
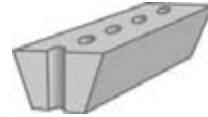

Profil section	Riemen belt Meter Euro	Plattenverbinder plate connectors Stück / piece Euro	Gelenkverbinder link connectors Stück / piece Euro
10	11,80	2,10	Preise auf Anfrage. Prices on request.
13	14,60	2,20	
17	18,90	2,50	
22	35,50	3,30	
Rolle = 50 m		Aufpreis für Anschnitte: 10 %	
roll = 50 m		Surcharge for shorter lengths: 10 %	

Gliederkeilriemen - Meterware Link Belts - open - ended

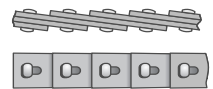
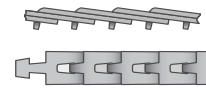

Power Twist		Power Link	
Profil / Section	Euro / m	Profil / Section	Euro / m
Z / 10	70,40	Z / 10	70,00
A / 13	82,80	A / 13	77,20
B / 17	91,00	B / 17	91,10
C / 22	140,70		
D / 32	319,80		
AA	103,40	Montagezange pliers	Stück / piece Euro
BB	113,80	Profil / section Z, A, B	41,30
CC	175,90		
Keine Montagezange erforderlich. Pliers are not necessary.			

Nu-T - Link mit Metallverbinder with metall connectors		Tab - Link ohne Metallverbinder without metall connectors	
Profil / Section	Euro / Meter	Profil / Section	Euro / Meter
Z	104,50	Z	116,20
A	112,90	A	116,20
B	122,90	B	129,50
C	192,20	C	219,80

Super - T - Link	
Profil / Section	Euro / Meter
SPA	157,10
SPB	173,80
SPC	267,60



Rolle = 20 m

roll = 20 m

Aufpreis für Anschnitte: 10 %

Surcharge for shorter lengths: 10 %

Beständig gegen Öl, Hitze, Wasser und viele Industriechemikalien.

Resistant against oil, heat, water and many industrial chemicals.

ConCar

Polyurethan - Weitwinkelriemen - 60°

Polyurethan Wide - Angle Belts - 60°

3M = 3 x 2 mm

5M = 5 x 3 mm

7M = 7 x 5 mm

11M = 11 x 7 mm

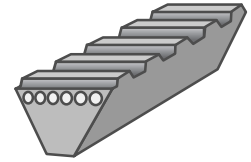

Außenlänge	Profil section 3 M	Profil section 5 M	Profil section 7 M	Profil section 11 M	Außenlänge	Profil section 3 M	Profil section 5 M	Profil section 7 M	Profil section 11 M
outside length mm	Stück piece Euro	Stück piece Euro	Stück piece Euro	Stück piece Euro	outside length mm	Stück piece Euro	Stück piece Euro	Stück piece Euro	Stück piece Euro
180	11,70				670	14,70	20,70	26,30	
185	11,70				690	14,90	20,90	26,40	
190	11,70				710	15,40	21,70	26,60	40,40
195	11,70				730	15,60	22,00	27,20	41,60
200	11,70				750	15,90	22,20	27,50	42,00
206	11,70				775		22,50	27,70	42,60
212	11,70				800		23,00	28,10	43,60
218	11,70				825		23,40	28,20	43,90
224	11,70				850		24,00	28,90	44,80
230	11,70				875		24,30	29,50	45,40
236	11,70				900		25,00	29,70	45,60
243	11,70				925		25,50	30,00	46,80
250	11,70				950		26,00	30,10	47,70
258	11,70				975		26,30	30,70	48,60
265	11,70				1000		26,60	31,00	48,90
272	11,70				1030		27,50	31,60	49,90
280	11,70	17,80			1060		27,90	32,00	50,50
290	11,70	17,80			1090		28,50	32,50	51,30
300	11,70	17,80			1120		29,00	33,20	51,90
307	11,70	17,80			1150		29,70	34,10	52,90
315	11,70	17,80			1180		30,20	34,30	54,00
325	11,70	17,80			1220		31,00	35,20	55,00
335	11,70	17,80			1250		31,70	36,00	55,80
345	11,70	17,80			1280		32,50	36,30	56,40
355	11,70	17,80			1320		33,30	36,60	56,80
365	11,70	17,80			1360		34,10	37,20	58,50
375	11,70	17,80			1400		34,50	38,00	59,60
387	11,70	17,80			1450		35,50	38,80	60,80
400	11,70	17,80			1500		36,30	39,60	62,00
412	11,70	17,80			1550			40,40	63,80
425	11,70	17,80			1600			41,60	65,40
437	11,70	17,80			1650			42,40	67,20
450	11,70	17,80			1700			43,60	68,20
462	12,40	17,80			1750			44,60	71,10
475	12,40	17,80			1800			45,60	72,20
487	12,60	17,80			1850		43,20	52,60	83,20
500	12,60	17,80	25,50		1900			53,90	84,80
515	13,30	17,80	25,50		1950			55,00	88,30
530	13,50	18,40	25,50		2000			56,40	89,40
545	13,50	18,70	25,50		2060			57,90	91,80
560	13,80	18,80	25,50		2120			59,10	93,50
580	13,80	19,40	25,50		2180			62,00	96,90
600	13,80	19,80	25,50		2240			63,80	99,70
615	14,00	19,90	25,50		2300			65,40	102,10
630	14,20	20,30	25,50						
650	14,50	20,40	26,00						
3M Verfügbarkeit auf Anfrage.									
3M availability on request.									

3M = 3 x 2 mm

5M = 5 x 3 mm

7M = 7 x 5 mm

11M = 11 x 7 mm

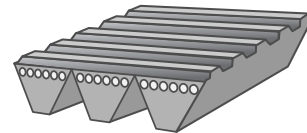

Außenlänge outside length mm	Profil section 5 MS Rippe rib Euro	Profil section 7 MS Rippe rib Euro	Profil section 11 MS Rippe rib Euro	Außenlänge outside length mm	Profil section 5 MS Rippe rib Euro	Profil section 7 MS Rippe rib Euro	Profil section 11 MS Rippe rib Euro
280	18,10			805	23,20		
290	18,10			825	23,80	29,30	44,70
300	18,10			837		29,40	
307	18,10			850	24,40	29,40	45,60
315	18,10			875	24,40	29,70	46,50
325	18,10			900	25,50	30,10	47,00
335	18,10			925	25,80	30,30	47,40
345	18,10			950	26,50	30,80	48,50
355	18,10			975	26,90	31,30	49,10
365	18,10			1000	27,20	31,50	49,50
375	18,10			1030	27,90	31,80	50,60
387	18,10			1060	28,10	32,80	51,50
400	18,10			1090	29,60	33,30	52,00
412	18,10			1120	29,70	33,70	53,20
425	18,10			1150	30,10	34,40	53,80
437	18,10			1180	30,40	34,70	54,80
450	18,10			1220	31,30	35,40	55,90
462	18,10			1250	31,80	36,00	56,40
475	18,10			1280	32,80	36,50	57,20
487	18,10			1320	33,50	37,60	58,60
500	18,10	25,90		1360		37,90	59,30
515	18,80	25,90		1400		39,00	60,40
518	18,80			1450		39,40	61,60
530	18,80	25,90		1500		40,40	63,20
545	19,00	25,90		1550		40,80	64,80
560	19,00	25,90		1600		42,10	66,60
563		25,90		1650		43,00	68,40
580	20,20	25,90		1700		44,00	70,00
600	20,40	25,90		1750		45,20	71,80
615	20,50	25,90		1800		46,50	73,30
630	20,50	25,90		1850		47,30	74,90
650	20,80	26,50		1900		48,50	76,60
670	20,90	26,60		1950		50,00	79,50
690	21,20	26,90		2000		50,60	80,50
710	21,90	27,20	41,40	2060		52,10	82,20
730	22,50	27,50	42,00	2120		53,80	84,70
750	22,90	27,60	42,80	2180		55,70	87,00
775	23,00	28,10	43,30	2240		57,20	89,40
800	23,20	29,10	44,00	2300		58,60	91,40

Profil/Section	PH	PJ	PK	PL	PM
e =	1,6	2,34	3,56	4,7	9,4
h =	3,0	3,50	5,50	7,0	13,0

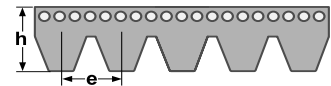

Profil/ Section PJ			Profil/ Section PL			Profil/ Section PM		
Type	Wirklänge pitch length	Rippe/rib Euro	Type	Wirklänge pitch length	Rippe/rib Euro	Type	Wirklänge pitch length	Rippe/rib Euro
130 J	330	1,40	410 L	1041	6,00	900 M	2286	32,60
140 J	356	1,40	423 L	1074	6,00	940 M	2388	33,50
150 J	381	1,40	452 L	1150	6,00	990 M	2515	35,20
160 J	406	1,40	460 L	1168	6,00	1060 M	2693	38,70
170 J	432	1,40	470 L	1194	6,00	1115 M	2832	39,50
180 J	457	1,40	480 L	1219	6,40	1150 M	2921	40,40
190 J	483	1,40	500 L	1270	6,40	1185 M	3010	41,40
200 J	508	1,40	510 L	1295	6,40	1230 M	3124	44,30
220 J	559	1,50	525 L	1334	6,50	1310 M	3327	47,60
230 J	584	1,50	540 L	1372	6,80	1390 M	3531	50,40
240 J	610	1,50	550 L	1397	6,80	1470 M	3734	51,80
260 J	660	1,50	560 L	1422	6,80	1610 M	4089	57,00
270 J	686	1,50	565 L	1435	7,70	1650 M	4191	57,50
280 J	711	1,50	580 L	1473	7,70	1760 M	4470	61,30
290 J	737	1,60	590 L	1499	7,70	1830 M	4648	65,00
300 J	762	1,60	615 L	1562	7,70	1980 M	5029	68,90
320 J	813	1,60	635 L	1613	8,00	2130 M	5410	74,10
330 J	838	1,60	650 L	1651	8,30	2410 M	6121	83,40
340 J	864	1,60	655 L	1664	8,30	2710 M	6883	94,20
360 J	914	1,60	675 L	1715	8,50	3010 M	7646	103,60
380 J	965	1,60	695 L	1765	8,60	3310 M	8408	114,50
390 J	990	1,60	710 L	1803	8,90	3610 M	9169	125,80
400 J	1016	1,60	725 L	1842	8,90	3910 M	9931	134,70
415 J	1054	1,60	765 L	1943	9,00	4210 M	10693	144,10
430 J	1092	1,70	780 L	1981	9,20	4810 M	12217	163,90
450 J	1143	1,70	795 L	2019	9,20	5410 M	13741	184,20
460 J	1168	1,70	815 L	2070	9,70	6010 M	15266	204,40
470 J	1194	1,80	825 L	2096	9,90	6600 M	16748	224,70
480 J	1219	1,80	840 L	2134	9,90			
490 J	1245	1,80	865 L	2197	10,30			
500 J	1270	1,80	880 L	2235	10,50			
510 J	1295	1,80	915 L	2324	10,80			
520 J	1321	2,10	930 L	2362	11,40			
540 J	1372	2,10	975 L	2476	11,80			
550 J	1397	2,10	990 L	2515	12,10			
580 J	1473	2,20	1010 L	2565	12,20	156 TB2	156	1,90
610 J	1549	2,20	1065 L	2705	12,70	170 TB2	170	1,90
630 J	1600	2,30	1080 L	2743	13,00	200 TB2	200	1,90
650 J	1651	2,30	1120 L	2845	13,60	220 TB2	220	1,90
670 J	1702	2,40	1140 L	2890	13,70	231 TB2	231	1,90
690 J	1753	2,50	1150 L	2921	13,80	248 TB2	248	1,90
700 J	1778	2,50	1180 L	2997	14,20	266 TB2	266	1,90
730 J	1854	2,70	1215 L	3086	14,60	295 TB2	295	1,90
770 J	1956	2,80	1230 L	3124	15,00	310 TB2	310	1,90
780 J	1981	2,80	1270 L	3226	15,30	327 TB2	327	1,90
820 J	2083	2,90	1295 L	3289	15,50	330 TB2	330	1,90
870 J	2210	3,00	1310 L	3327	15,60	333 TB2	333	1,90
920 J	2337	3,50	1375 L	3493	16,60	345 TB2	345	1,90
980 J	2489	3,50	1455 L	3696	17,40	360 TB2	360	1,90
			1595 L	4051	19,10	380 TB2	380	1,90
			1650 L	4191	19,80	400 TB2	400	2,00
			1760 L	4470	21,20	430 TB2	430	2,00
			1820 L	4623	22,00	480 TB2	480	2,00
			1980 L	5029	23,80	510 TB2	510	2,00
			2120 L	5385	25,90	526 TB2	526	2,00
			2400 L	6096	29,40	535 TB2	535	2,00
						598 TB2	598	2,00
						630 TB2	630	2,00
						660 TB2	660	2,00
						675 TB2	675	2,00
						725 TB2	725	2,10
						770 TB2	770	2,20
						1186 TB2	1186	2,90
Profil PH und PK auf Anfrage.								
Section PH and PK on request.								
Wickelpreise auf Anfrage.								
Prices of sleeves on request.			Weitere Typen auf Anfrage.					
			Further types on request.					

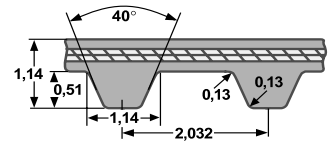

Type MXL - Teilung/ Pitch 2,032 mm

	Wirklänge pitch length		Zoll / Inch mm Zoll / Inch	Breite / width		
				1/8 3,175 012	3/16 4,763 019	1/4 6,35 025
	Zoll / inch	mm	Zähne teeth	Stück piece Euro	Stück piece Euro	Stück piece Euro
44 MXL	3,52	89,41	44	1,20	1,60	1,80
45 MXL	3,60	91,44	45	1,20	1,60	1,80
48 MXL	3,84	97,54	48	1,20	1,60	1,80
50 MXL	4,00	101,60	50	1,20	1,60	1,80
52 MXL	4,16	105,66	52	1,20	1,60	1,80
53 MXL	4,25	107,97	53	1,20	1,60	1,80
54 MXL	4,32	109,73	54	1,20	1,60	1,80
55 MXL	4,64	117,76	55	1,20	1,60	1,80
56 MXL	4,48	113,79	56	1,20	1,60	1,80
57 MXL	4,56	115,82	57	1,30	1,60	2,00
59 MXL	4,72	119,89	59	1,30	1,60	2,00
60 MXL	4,80	121,92	60	1,30	1,60	2,00
61 MXL	4,88	123,95	61	1,30	1,60	2,00
62 MXL	4,96	125,98	62	1,30	1,60	2,00
63 MXL	5,04	128,02	63	1,30	1,60	2,00
65 MXL	5,20	132,08	65	1,30	1,60	2,00
67 MXL	5,36	136,14	67	1,30	1,60	2,00
68 MXL	5,44	138,18	68	1,30	1,60	2,00
69 MXL	5,52	140,21	69	1,30	1,60	2,00
70 MXL	5,60	142,24	70	1,30	1,60	2,00
71 MXL	5,68	144,27	71	1,30	1,60	2,00
72 MXL	5,76	146,30	72	1,30	1,60	2,00
73 MXL	5,84	148,34	73	1,30	1,60	2,00
74 MXL	5,92	150,37	74	1,30	1,60	2,00
75 MXL	6,00	152,40	75	1,30	1,60	2,00
76 MXL	6,08	154,43	76	1,30	1,60	2,00
77 MXL	6,16	156,46	77	1,30	1,60	2,00
78 MXL	6,24	158,50	78	1,30	1,60	2,00
79 MXL	6,32	160,53	79	1,30	1,60	2,00
80 MXL	6,40	162,56	80	1,30	1,70	2,00
82 MXL	6,56	166,62	82	1,30	1,70	2,00
83 MXL	6,64	168,66	83	1,30	1,70	2,00
85 MXL	6,80	172,72	85	1,30	1,70	2,00
86 MXL	6,88	174,75	86	1,30	1,70	2,00
87 MXL	6,96	176,78	87	1,30	1,70	2,00
88 MXL	7,04	178,82	88	1,30	1,70	2,00
90 MXL	7,20	182,88	90	1,30	1,70	2,00
91 MXL	7,28	184,91	91	1,30	1,70	2,00
92 MXL	7,36	186,94	92	1,30	1,70	2,00
93 MXL	7,44	188,98	93	1,30	1,70	2,00
94 MXL	7,52	191,01	94	1,30	1,70	2,00
95 MXL	7,60	193,04	95	1,30	1,70	2,00
96 MXL	7,68	195,07	96	1,30	1,70	2,00
97 MXL	7,76	197,10	97	1,30	1,70	2,00
98 MXL	7,84	199,14	98	1,30	1,70	2,00
99 MXL	7,92	201,17	99	1,30	1,70	2,00
100 MXL	8,00	203,20	100	1,30	1,70	2,00
101 MXL	8,08	205,23	101	1,30	1,70	2,00
102 MXL	8,16	207,26	102	1,30	1,70	2,00
103 MXL	8,24	209,30	103	1,30	1,70	2,00
104 MXL	8,32	211,33	104	1,30	1,70	2,00
105 MXL	8,40	213,36	105	1,30	1,70	2,00
106 MXL	8,48	215,39	106	1,30	1,70	2,00
108 MXL	8,64	219,46	108	1,40	1,80	2,00
109 MXL	8,72	221,49	109	1,50	1,80	2,10
110 MXL	9,19	233,52	110	1,50	1,80	2,10
112 MXL	8,96	227,58	112	1,50	1,80	2,10
114 MXL	9,12	231,65	114	1,50	1,80	2,10
115 MXL	9,20	233,68	115	1,50	1,80	2,10
118 MXL	9,44	239,78	118	1,50	2,00	2,10

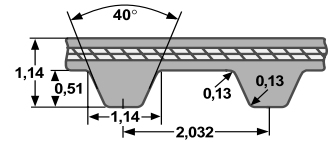

Type MXL - Teilung/ Pitch 2,032 mm

	Zoll / Inch mm Zoll / Inch		Breite / width		Breite / width	
			1/8 3,175 012	3/16 4,763 019	1/4 6,35 025	
	Wirklänge pitch length		Zähne teeth	Stück piece Euro	Stück piece Euro	Stück piece Euro
	Zoll / inch	mm				
119 MXL	9,52	241,81	119	1,50	2,00	2,10
120 MXL	9,60	243,84	120	1,50	2,00	2,10
122 MXL	9,76	247,90	122	1,50	2,00	2,10
123 MXL	9,84	249,94	123	1,50	2,00	2,10
124 MXL	9,92	251,97	124	1,50	2,00	2,10
125 MXL	10,00	254,00	125	1,50	2,00	2,10
126 MXL	10,08	256,03	126	1,50	2,00	2,10
127 MXL	10,16	258,06	127	1,50	2,00	2,10
128 MXL	10,24	260,10	128	1,50	2,00	2,10
129 MXL	10,32	262,13	129	1,50	2,00	2,10
130 MXL	10,40	264,16	130	1,50	2,00	2,10
131 MXL	10,48	266,19	131	1,50	2,00	2,10
132 MXL	10,56	268,22	132	1,50	2,00	2,10
134 MXL	10,72	272,29	134	1,50	2,00	2,10
135 MXL	10,80	274,32	135	1,60	2,00	2,20
137 MXL	10,96	278,38	137	1,60	2,00	2,20
138 MXL	11,04	280,42	138	1,60	2,00	2,20
140 MXL	11,20	284,48	140	1,60	2,00	2,20
142 MXL	11,36	288,54	142	1,60	2,00	2,20
144 MXL	11,52	292,61	144	1,60	2,00	2,20
146 MXL	11,68	296,67	146	1,60	2,00	2,20
150 MXL	12,00	304,80	150	1,60	2,00	2,20
151 MXL	12,08	306,83	151	1,60	2,00	2,20
155 MXL	12,40	314,96	155	1,60	2,00	2,20
158 MXL	12,64	321,06	158	1,60	2,00	2,20
160 MXL	12,80	325,12	160	1,60	2,00	2,20
162 MXL	12,96	329,18	162	1,60	2,00	2,20
164 MXL	13,12	333,25	164	1,60	2,00	2,20
165 MXL	13,20	335,28	165	1,60	2,00	2,20
169 MXL	13,52	343,41	169	1,60	2,00	2,20
170 MXL	13,60	345,44	170	1,60	2,00	2,20
175 MXL	14,00	355,60	175	1,60	2,10	2,30
180 MXL	14,40	365,76	180	1,60	2,10	2,30
184 MXL	14,72	373,89	184	1,80	2,20	2,40
188 MXL	15,04	382,02	188	1,80	2,20	2,40
190 MXL	15,20	386,08	190	1,80	2,20	2,40
192 MXL	15,36	390,14	192	2,00	2,20	2,40
195 MXL	15,60	396,24	195	2,00	2,20	2,40
196 MXL	15,68	398,27	196	2,00	2,20	2,40
200 MXL	16,00	406,40	200	2,00	2,20	2,40
204 MXL	16,32	414,53	204	2,00	2,30	2,50
205 MXL	16,40	416,56	205	2,00	2,30	2,50
210 MXL	16,80	426,72	210	2,00	2,30	2,50
212 MXL	16,96	430,78	212	2,00	2,30	2,50
215 MXL	17,20	436,88	215	2,00	2,30	2,50
220 MXL	17,60	447,04	220	2,00	2,30	2,50
221 MXL	17,68	449,07	221	2,00	2,30	2,50
222 MXL	17,76	451,10	222	2,10	2,30	2,50
224 MXL	17,92	455,17	224	2,10	2,30	2,50
225 MXL	17,99	457,00	225	2,10	2,30	2,50
226 MXL	18,08	459,23	226	2,10	2,30	2,70
228 MXL	18,24	463,30	228	2,10	2,30	2,70
230 MXL	18,40	467,36	230	2,10	2,30	2,70
232 MXL	18,56	471,42	232	2,10	2,30	2,70
234 MXL	18,72	475,49	234	2,10	2,30	2,70
236 MXL	18,88	479,55	236	2,10	2,30	2,70
239 MXL	19,12	485,65	239	2,10	2,30	2,70
240 MXL	19,20	487,68	240	2,10	2,30	2,70
245 MXL	19,60	497,84	245	2,10	2,30	2,70
248 MXL	19,84	503,94	248	2,10	2,30	2,70

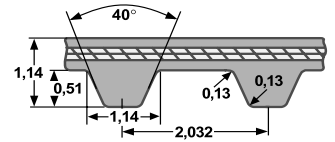

Type MXL - Teilung/ Pitch 2,032 mm

	Wirklänge pitch length		Zoll / Inch mm Zoll / Inch	Breite / width		
				1/8 3,175 012	3/16 4,763 019	1/4 6,35 025
	Zoll/ inch	mm	Zähne teeth	Stück piece Euro	Stück piece Euro	Stück piece Euro
249 MXL	19,92	505,97	249	2,20	2,40	2,80
250 MXL	20,00	508,00	250	2,20	2,40	2,80
251 MXL	20,08	510,03	251	2,20	2,40	2,80
256 MXL	20,48	520,19	256	2,20	2,40	2,80
260 MXL	20,80	528,32	260	2,30	2,50	2,90
262 MXL	20,96	532,38	262	2,30	2,50	2,90
265 MXL	21,20	538,48	265	2,30	2,50	2,90
268 MXL	21,44	544,58	268	2,30	2,50	2,90
271 MXL	21,68	550,67	271	2,30	2,50	2,90
273 MXL	21,84	554,74	273	2,30	2,50	2,90
275 MXL	22,00	558,80	275	2,30	2,50	2,90
280 MXL	22,40	568,96	280	2,30	2,50	2,90
281 MXL	22,48	570,99	281	2,40	2,50	3,00
290 MXL	23,20	589,28	290	2,40	2,50	3,00
295 MXL	23,60	599,44	295	2,40	2,50	3,00
300 MXL	24,00	609,60	300	2,40	2,50	3,00
305 MXL	24,40	619,76	305	2,40	2,50	3,00
308 MXL	24,64	625,86	308	2,40	2,50	3,00
310 MXL	24,80	629,92	310	2,40	2,50	3,00
312 MXL	24,96	633,98	312	2,40	2,70	3,10
315 MXL	25,20	640,08	315	2,40	2,70	3,10
318 MXL	25,44	646,18	318	2,50	2,80	3,40
320 MXL	25,60	650,24	320	2,50	2,80	3,40
323 MXL	25,84	656,34	323	2,50	2,80	3,40
326 MXL	26,08	662,43	326	2,50	2,80	3,40
328 MXL	26,24	666,50	328	2,50	2,80	3,40
330 MXL	26,40	670,56	330	2,50	2,80	3,40
332 MXL	26,56	674,62	332	2,50	2,80	3,40
334 MXL	26,72	678,69	334	2,50	2,80	3,40
336 MXL	26,88	682,75	336	2,50	2,80	3,40
337 MXL	26,96	684,78	337	2,50	2,80	3,40
347 MXL	27,76	705,10	347	2,50	2,80	3,40
350 MXL	28,00	711,20	350	2,50	2,90	3,40
354 MXL	28,32	719,33	354	2,50	2,90	3,40
355 MXL	28,40	721,36	355	2,50	2,90	3,40
358 MXL	28,64	727,46	358	2,50	2,90	3,40
359 MXL	28,72	729,49	359	2,50	2,90	3,40
360 MXL	28,80	731,52	360	2,50	2,90	3,40
364 MXL	29,12	739,65	364	2,50	2,90	3,40
365 MXL	29,20	741,68	365	2,50	2,90	3,40
371 MXL	29,68	753,87	371	2,80	3,00	3,60
372 MXL	29,76	755,90	372	2,80	3,00	3,60
380 MXL	30,40	772,16	380	2,80	3,00	3,60
388 MXL	31,04	788,42	388	2,80	3,00	3,60
397 MXL	31,76	806,70	397	2,80	3,00	3,60
400 MXL	32,00	812,80	400	2,80	3,00	3,60
402 MXL	32,16	816,86	402	2,90	3,40	3,70
410 MXL	32,80	833,12	410	2,90	3,40	3,70
413 MXL	33,04	839,22	413	2,90	3,40	3,70
425 MXL	34,00	863,60	425	2,90	3,40	3,70
434 MXL	34,72	881,89	434	2,90	3,40	3,70
435 MXL	34,80	883,92	435	3,00	3,40	3,80
448 MXL	35,84	910,34	448	3,00	3,40	3,80
453 MXL	32,30	820,50	453	3,00	3,40	3,80
468 MXL	37,44	950,98	468	3,30	3,60	4,10
473 MXL	37,84	961,14	473	3,30	3,60	4,10
475 MXL	38,00	965,20	475	3,30	3,60	4,10
480 MXL	38,40	975,36	480	3,30	3,60	4,10
487 MXL	38,96	989,58	487	3,30	3,60	4,10
493 MXL	39,44	1001,78	493	3,30	3,60	4,10

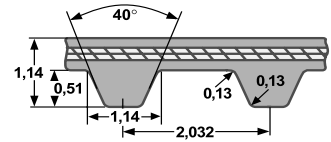

Type MXL - Teilung/ Pitch 2,032 mm

		Zoll/ Inch mm Zoll/ Inch	Breite/width			
			1/8 3,175 012	3/16 4,763 019	1/4 6,35 025	
	Wirklänge pitch length		Zähne teeth	Stück piece Euro	Stück piece Euro	Stück piece Euro
	Zoll/ inch	mm				
498 MXL	39,84	1011,94	498	3,30	3,60	4,10
500 MXL	40,00	1016,00	500	3,30	3,60	4,10
516 MXL	41,28	1048,51	516	3,40	3,70	4,20
522 MXL	41,76	1060,70	522	3,40	3,70	4,20
524 MXL	41,92	1064,77	524	3,40	3,80	4,30
525 MXL	42,00	1066,80	525	3,40	3,80	4,30
535 MXL	42,80	1087,12	535	3,60	3,90	4,60
550 MXL	44,00	1117,60	550	3,60	3,90	4,60
665 MXL	53,20	1351,28	665	4,20	4,90	5,40

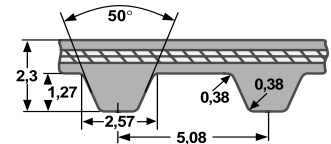

Type XL - Teilung/ Pitch 5,08 mm

		Zoll/ Inch mm Zoll/ Inch	Breite/width						
			1/4 6,35 025	5/16 7,94 031	3/8 9,53 037	1/2 12,7 050	3/4 19,05 075	1 25,4 100	
	Wirklänge pitch length		Zähne teeth	Stück piece Euro	Stück piece Euro	Stück piece Euro	Stück piece Euro	Stück piece Euro	Stück piece Euro
	Zoll/ inch	mm							
50 XL	5,0	127,0	25	1,80	2,10	2,30	3,00	4,10	5,40
54 XL	5,4	137,2	27	1,80	2,10	2,30	3,00	4,10	5,40
60 XL	6,0	152,40	30	1,80	2,10	2,30	3,00	4,10	5,40
64 XL	6,4	162,56	32	1,80	2,30	2,50	3,10	4,10	5,40
68 XL	6,8	172,72	34	1,80	2,30	2,50	3,10	4,10	5,40
70 XL	7,0	177,80	35	1,80	2,30	2,50	3,10	4,10	5,40
72 XL	7,2	182,88	36	2,00	2,30	2,50	3,10	4,60	5,70
74 XL	7,4	187,96	37	2,00	2,30	2,50	3,10	4,60	5,70
76 XL	7,6	193,04	38	2,00	2,30	2,50	3,10	4,60	5,70
78 XL	7,8	198,12	39	2,00	2,30	2,50	3,10	4,60	5,70
80 XL	8,0	203,20	40	2,00	2,30	2,50	3,10	4,60	5,70
84 XL	8,4	213,36	42	2,00	2,40	2,70	3,30	4,70	5,80
88 XL	8,8	223,52	44	2,00	2,40	2,70	3,30	4,70	5,80
90 XL	9,0	228,60	45	2,00	2,40	2,70	3,30	4,70	5,80
92 XL	9,2	233,68	46	2,20	2,50	2,70	3,40	4,90	6,00
94 XL	9,4	238,76	47	2,20	2,50	2,70	3,40	4,90	6,00
96 XL	9,6	243,84	48	2,20	2,50	2,70	3,40	4,90	6,00
98 XL	9,8	248,92	49	2,20	2,50	2,70	3,40	4,90	6,00
100 XL	10,0	254,00	50	2,20	2,50	2,70	3,40	4,90	6,00
102 XL	10,2	259,08	51	2,20	2,50	2,80	3,50	4,90	6,20
104 XL	10,4	264,16	52	2,20	2,50	2,80	3,50	4,90	6,20
106 XL	10,6	269,24	53	2,20	2,50	2,80	3,50	4,90	6,20
108 XL	10,8	274,32	54	2,20	2,50	2,80	3,50	4,90	6,20
110 XL	11,0	279,40	55	2,20	2,50	2,80	3,50	4,90	6,20
112 XL	11,2	284,48	56	2,30	2,50	2,90	3,60	5,00	6,40
114 XL	11,4	289,56	57	2,30	2,50	2,90	3,60	5,00	6,40
116 XL	11,6	294,64	58	2,30	2,50	2,90	3,60	5,00	6,40
118 XL	11,8	299,72	59	2,30	2,50	2,90	3,60	5,00	6,40
120 XL	12,0	304,80	60	2,30	2,50	2,90	3,60	5,00	6,40
122 XL	12,2	309,88	61	2,30	2,70	3,00	3,70	5,10	6,70
124 XL	12,4	314,96	62	2,30	2,70	3,00	3,70	5,10	6,70
126 XL	12,6	320,04	63	2,30	2,70	3,00	3,70	5,10	6,70
128 XL	12,8	325,12	64	2,30	2,70	3,00	3,70	5,10	6,70
130 XL	13,0	330,20	65	2,30	2,70	3,00	3,70	5,10	6,70
134 XL	13,4	340,36	67	2,40	2,70	3,10	3,70	5,40	6,80

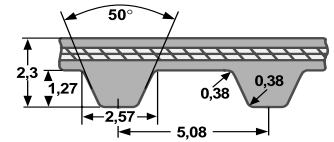

Type XL - Teilung/ Pitch 5,08 mm

			Zoll/ inch mm Zoll/ inch	Breite/width	Breite/width	Breite/width	Breite/width	Breite/width	Breite/width
				¼	5/16	3/8	1/2	¾	1
				6,35 025	7,94 031	9,53 037	12,7 050	19,05 075	25,4 100
	Wirklänge pitch length		Zähne teeth	Stück piece Euro	Stück piece Euro	Stück piece Euro	Stück piece Euro	Stück piece Euro	Stück piece Euro
	Zoll/ inch	mm							
136 XL	13,6	345,44	68	2,40	2,70	3,10	3,70	5,40	6,80
138 XL	13,8	350,52	69	2,40	2,70	3,10	3,70	5,40	6,80
140 XL	14,0	355,60	70	2,40	2,70	3,10	3,70	5,40	6,80
142 XL	14,2	360,48	71	2,50	2,80	3,10	3,90	5,40	7,00
144 XL	14,4	365,76	72	2,50	2,80	3,10	3,90	5,40	7,00
146 XL	14,6	370,84	73	2,50	2,80	3,10	3,90	5,40	7,00
148 XL	14,8	375,92	74	2,50	2,80	3,10	3,90	5,40	7,00
150 XL	15,0	381,00	75	2,50	2,80	3,10	3,90	5,40	7,00
152 XL	15,2	386,08	76	2,50	2,80	3,10	4,00	5,70	7,40
154 XL	15,4	391,16	77	2,50	2,80	3,10	4,00	5,70	7,40
156 XL	15,6	396,24	78	2,50	2,80	3,10	4,00	5,70	7,40
158 XL	15,8	401,32	79	2,50	2,80	3,10	4,00	5,70	7,40
160 XL	16,0	406,40	80	2,50	2,80	3,10	4,00	5,70	7,40
162 XL	16,2	411,48	81	2,50	2,90	3,30	4,10	5,80	7,40
164 XL	16,4	416,56	82	2,50	2,90	3,30	4,10	5,80	7,40
166 XL	16,6	421,64	83	2,50	2,90	3,30	4,10	5,80	7,40
168 XL	16,8	426,72	84	2,50	2,90	3,30	4,10	5,80	7,40
170 XL	17,0	431,80	85	2,50	2,90	3,30	4,10	5,80	7,40
172 XL	17,2	436,88	86	2,70	3,00	3,40	4,10	5,90	7,50
174 XL	17,4	441,96	87	2,70	3,00	3,40	4,10	5,90	7,50
176 XL	17,6	447,04	88	2,70	3,00	3,40	4,10	5,90	7,50
178 XL	17,8	452,12	89	2,70	3,00	3,40	4,10	5,90	7,50
180 XL	18,0	457,20	90	2,70	3,00	3,40	4,10	5,90	7,50
182 XL	18,2	462,28	91	2,70	3,00	3,50	4,20	6,00	7,90
184 XL	18,4	467,36	92	2,70	3,00	3,50	4,20	6,00	7,90
186 XL	18,6	472,44	93	2,70	3,00	3,50	4,20	6,00	7,90
188 XL	18,8	477,52	94	2,70	3,00	3,50	4,20	6,00	7,90
190 XL	19,0	482,60	95	2,70	3,00	3,50	4,20	6,00	7,90
192 XL	19,2	487,68	96	2,80	3,10	3,50	4,30	6,20	8,00
194 XL	19,4	492,76	97	2,80	3,10	3,50	4,30	6,20	8,00
196 XL	19,6	497,84	98	2,80	3,10	3,50	4,30	6,20	8,00
198 XL	19,8	502,92	99	2,80	3,10	3,50	4,30	6,20	8,00
200 XL	20,0	508,00	100	2,80	3,10	3,50	4,30	6,20	8,00
202 XL	20,2	513,08	101	2,80	3,10	3,60	4,60	6,40	8,10
204 XL	20,4	518,16	102	2,80	3,10	3,60	4,60	6,40	8,10
206 XL	20,6	523,24	103	2,80	3,10	3,60	4,60	6,40	8,10
208 XL	20,8	528,32	104	2,80	3,10	3,60	4,60	6,40	8,10
210 XL	21,0	533,40	105	2,80	3,10	3,60	4,60	6,40	8,10
212 XL	21,2	538,48	106	2,90	3,10	3,70	4,80	6,60	8,60
214 XL	21,4	543,56	107	2,90	3,10	3,70	4,80	6,60	8,60
216 XL	21,6	548,64	108	2,90	3,10	3,70	4,80	6,60	8,60
218 XL	21,8	553,72	109	2,90	3,10	3,70	4,80	6,60	8,60
220 XL	22,0	558,80	110	2,90	3,10	3,70	4,80	6,60	8,60
222 XL	22,2	563,88	111	3,00	3,30	3,70	4,90	6,70	8,60
224 XL	22,4	568,96	112	3,00	3,30	3,70	4,90	6,70	8,60
228 XL	22,8	579,12	114	3,00	3,30	3,70	4,90	6,70	8,60
230 XL	23,0	584,20	115	3,00	3,30	3,70	4,90	6,70	8,60
234 XL	23,4	594,36	117	3,00	3,40	3,90	4,90	6,80	8,70
236 XL	23,6	599,44	118	3,00	3,40	3,90	4,90	6,80	8,70
240 XL	24,0	609,60	120	3,00	3,40	3,90	4,90	6,80	8,70
244 XL	24,4	619,76	122	3,10	3,50	3,90	5,00	7,00	9,10
248 XL	24,8	629,92	124	3,10	3,50	3,90	5,00	7,00	9,10
250 XL	25,0	635,00	125	3,10	3,50	3,90	5,00	7,00	9,10
254 XL	25,4	645,16	127	3,10	3,50	4,00	5,10	7,10	9,20
260 XL	26,0	660,40	130	3,10	3,50	4,00	5,10	7,10	9,20
262 XL	26,2	665,48	131	3,10	3,60	4,00	5,10	7,40	9,30
266 XL	26,6	675,64	133	3,10	3,60	4,00	5,10	7,40	9,30
270 XL	27,0	685,80	135	3,10	3,60	4,00	5,10	7,40	9,30
276 XL	27,6	701,04	138	3,30	3,60	4,10	5,30	7,40	9,70
280 XL	28,0	711,20	140	3,30	3,60	4,10	5,30	7,40	9,70

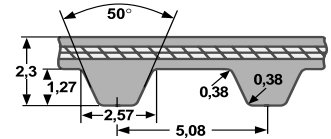

Type XL - Teilung/ Pitch 5,08 mm

		Zoll/ Inch mm	Zoll/ Inch	Breite/width ¼	Breite/width 5/16	Breite/width 3/8	Breite/width 1/2	Breite/width ¾	Breite/width 1
	Wirklänge pitch length		Zähne teeth	Stück piece Euro	Stück piece Euro	Stück piece Euro	Stück piece Euro	Stück piece Euro	Stück piece Euro
	Zoll/ inch	mm							
282 XL	28,2	716,28	141	3,40	3,70	4,10	5,30	7,50	10,00
290 XL	29,0	736,60	145	3,40	3,70	4,10	5,30	7,50	10,00
300 XL	30,0	762,00	150	3,50	3,70	4,30	5,30	7,90	10,30
310 XL	31,0	787,40	155	3,50	3,70	4,30	5,30	7,90	10,30
314 XL	31,4	797,56	157	3,50	3,70	4,30	5,30	7,90	10,30
316 XL	31,6	802,64	158	3,50	3,90	4,60	5,30	8,00	10,50
320 XL	32,0	812,80	160	3,50	3,90	4,60	5,30	8,00	10,50
322 XL	32,2	817,88	161	3,50	3,90	4,60	5,30	8,00	10,50
330 XL	33,0	833,20	165	3,50	3,90	4,60	5,30	8,00	10,50
332 XL	33,2	843,28	166	3,90	4,30	5,10	6,40	8,90	11,70
340 XL	34,0	863,60	170	3,90	4,30	5,10	6,40	8,90	11,70
344 XL	34,4	873,76	172	3,90	4,30	5,10	6,40	8,90	11,70
348 XL	34,8	883,92	174	3,90	4,30	5,10	6,40	8,90	11,70
352 XL	35,2	894,08	176	3,90	4,30	5,10	6,40	8,90	11,70
356 XL	35,6	904,24	178	3,90	4,30	5,10	6,40	8,90	11,70
360 XL	36,0	914,40	180	3,90	4,30	5,10	6,40	8,90	11,70
364 XL	36,4	924,56	182	3,90	4,30	5,10	6,40	8,90	11,70
370 XL	37,0	939,80	185	3,90	4,30	5,10	6,40	8,90	11,70
372 XL	37,2	944,88	186	3,90	4,30	5,10	6,40	8,90	11,70
376 XL	37,6	955,04	188	3,90	4,30	5,10	6,40	8,90	11,70
380 XL	38,0	965,20	190	3,90	4,30	5,10	6,40	8,90	11,70
384 XL	38,4	975,36	192	3,90	4,30	5,10	6,40	8,90	11,70
386 XL	38,6	980,44	193	3,90	4,30	5,10	6,40	8,90	11,70
388 XL	38,8	985,52	194	3,90	4,30	5,10	6,40	8,90	11,70
390 XL	39,0	990,60	195	3,90	4,30	5,10	6,40	8,90	11,70
392 XL	39,2	995,68	196	4,30	4,90	5,80	7,40	10,30	13,20
396 XL	39,6	1005,84	198	4,70	5,20	6,20	7,40	11,00	14,00
400 XL	40,0	1016,00	200	4,70	5,20	6,20	7,40	11,00	14,00
408 XL	40,8	1036,32	204	4,70	5,20	6,20	7,40	11,00	14,00
414 XL	41,4	1051,56	207	4,70	5,20	6,20	7,40	11,00	14,00
424 XL	42,4	1076,96	212	5,30	5,90	7,10	8,50	12,50	16,00
430 XL	43,0	1092,20	215	5,30	5,90	7,10	8,50	12,50	16,00
434 XL	43,4	1102,36	217	5,30	5,90	7,10	8,50	12,50	16,00
450 XL	45,0	1143,00	225	5,30	5,90	7,10	8,50	12,50	16,00
456 XL	45,6	1158,24	228	5,30	5,90	7,10	8,50	12,50	16,00
460 XL	46,0	1168,40	230	5,30	5,90	7,10	8,50	12,50	16,00
470 XL	47,0	1193,80	235	6,00	6,80	8,00	9,50	14,20	18,40
478 XL	47,8	1214,12	239	6,00	6,80	8,00	9,50	14,20	18,40
480 XL	48,0	1219,20	240	6,00	6,80	8,00	9,50	14,20	18,40
490 XL	49,0	1244,60	245	6,00	6,80	8,00	9,50	14,20	18,40
496 XL	49,6	1259,84	248	6,00	6,80	8,00	9,50	14,20	18,40
510 XL	51,0	1295,40	255	6,00	6,80	8,00	9,50	14,20	18,40
522 XL	52,2	1325,88	261	6,80	6,80	8,00	9,50	14,20	18,40
530 XL	53,0	1346,20	265	6,80	7,60	9,00	10,60	16,00	20,60
532 XL	53,2	1351,28	266	6,80	7,60	9,00	10,60	16,00	20,60
540 XL	54,0	1371,60	270	6,80	7,60	9,00	10,60	16,00	20,60
552 XL	55,2	1402,08	276	6,80	7,60	9,00	10,60	16,00	20,60
564 XL	56,4	1432,56	282	6,80	7,60	9,00	10,60	16,00	20,60
592 XL	59,2	1503,68	296	7,40	8,30	9,80	11,70	17,40	22,40
600 XL	60,0	1524,00	300	7,40	8,30	9,80	11,70	17,40	22,40
608 XL	60,8	1544,32	304	7,40	8,30	9,80	11,70	17,40	22,40
616 XL	61,6	1564,64	308	7,40	8,30	9,80	11,70	17,40	22,40
630 XL	63,0	1600,20	315	7,40	8,30	9,80	11,70	17,40	22,40
638 XL	63,8	1620,52	319	9,80	10,90	12,80	15,90	22,80	29,30
670 XL	67,0	1701,80	335	9,80	10,90	12,80	15,90	22,80	29,30
686 XL	68,6	1742,44	343	9,80	10,90	12,80	15,90	22,80	29,30
710 XL	71,0	1803,40	355	9,80	10,90	12,80	15,90	22,80	29,30
754 XL	75,4	1915,16	377	9,80	10,90	12,80	15,90	22,80	29,30
828 XL	82,8	2103,12	414	9,80	10,90	12,80	15,90	22,80	29,30
860 XL	86,0	2184,40	430	10,10	11,20	14,10	17,00	25,00	30,40

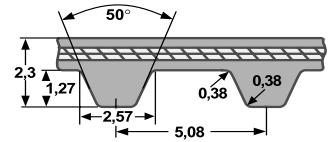

Type XL - Teilung/ Pitch 5,08 mm

			Zoll/ Inch mm Zoll/ Inch	Breite/width	Breite/width	Breite/width	Breite/width	Breite/width	Breite/width
				1/4	5/16	3/8	1/2	3/4	1
				6,35	7,94	9,53	12,7	19,05	25,4
				025	031	037	050	075	100
	Wirklänge pitch length		Zähne teeth	Stück piece Euro	Stück piece Euro	Stück piece Euro	Stück piece Euro	Stück piece Euro	Stück piece Euro
	Zoll/ inch	mm							
888 XL	88,8	2255,52	444	10,10	11,20	14,10	16,70	25,00	30,40
900 XL	90,0	2286,00	450	10,10	11,20	14,10	16,70	25,00	30,40
908 XL	90,8	2306,32	454	10,10	11,20	14,10	16,70	25,00	30,40
912 XL	91,2	2316,48	456	11,40	12,60	15,90	18,80	28,10	34,20
914 XL	91,4	2321,56	457	11,40	12,60	15,90	18,80	28,10	34,20
926 XL	92,6	2352,04	463	11,40	12,60	15,90	18,80	28,10	34,20
1014 XL	101,4	2575,56	507	11,40	12,60	15,90	18,80	28,10	34,20
1020 XL	102,0	2590,80	510	11,40	12,60	15,90	18,80	28,10	34,20

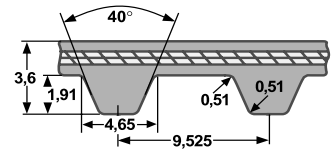

Type L - Teilung/ Pitch 9,525 mm

			Zoll/ inch mm Zoll/ inch	Breite/width	Breite/width	Breite/width	Breite/width	Breite/width	Breite/width
				1/2	3/4	1	1 1/2	2	3
				12,7	19,05	25,4	38,1	50,8	76,2
				050	075	100	150	200	300
	Wirklänge pitch length		Zähne teeth	Stück piece Euro	Stück piece Euro	Stück piece Euro	Stück piece Euro	Stück piece Euro	Stück piece Euro
	Zoll/ inch	mm							
98 L	9,8	247,65	26	4,80	6,70	8,60	12,90	17,20	25,70
109 L	10,9	276,22	29	4,80	6,70	8,60	12,90	17,20	25,70
124 L	12,4	314,40	33	4,80	6,70	8,60	12,90	17,20	25,70
135 L	13,5	342,90	36	5,30	7,40	9,70	14,20	19,00	28,50
150 L	15,0	381,00	40	5,30	7,40	9,70	14,20	19,00	28,50
165 L	16,5	419,10	44	6,00	8,40	10,60	15,80	21,20	31,70
169 L	16,9	428,63	45	6,00	8,40	10,60	15,80	21,20	31,70
172 L	17,3	438,15	46	6,00	8,40	10,60	15,80	21,20	31,70
187 L	18,8	476,00	50	6,00	8,40	10,60	15,80	21,20	31,70
203 L	20,3	514,35	54	6,40	9,00	11,50	17,30	22,90	34,50
210 L	21,0	533,40	56	6,40	9,00	11,50	17,30	22,90	34,50
218 L	21,8	553,72	58	6,60	9,20	11,80	17,70	23,70	35,50
225 L	22,5	571,50	60	6,60	9,20	11,80	17,70	23,70	35,50
232 L	23,2	589,28	62	7,00	9,90	12,50	18,80	24,90	37,60
240 L	24,0	609,60	64	7,00	9,90	12,50	18,80	24,90	37,60
248 L	24,8	629,92	66	7,20	10,00	12,80	19,30	25,70	38,60
255 L	25,5	647,70	68	7,20	10,00	12,80	19,30	25,70	38,60
263 L	26,3	666,75	70	7,40	10,40	13,60	20,30	27,20	41,10
265 L	26,5	676,27	71	7,40	10,40	13,60	20,30	27,20	41,10
270 L	27,0	685,80	72	7,40	10,40	13,60	20,30	27,20	41,10
277 L	27,8	704,85	74	7,50	10,80	14,00	21,00	28,00	41,80
285 L	28,5	723,90	76	7,50	10,80	14,00	21,00	28,00	41,80
300 L	30,0	762,00	80	8,10	11,10	14,50	21,70	29,00	43,50
304 L	30,4	771,53	81	8,40	11,70	15,30	22,90	30,70	45,80
315 L	31,5	800,10	84	8,40	11,70	15,30	22,90	30,70	45,80
320 L	31,9	809,63	85	8,40	11,70	15,30	22,90	30,70	45,80
322 L	32,3	819,10	86	8,40	11,70	15,30	22,90	30,70	45,80
334 L	33,4	847,73	89	8,70	12,30	15,80	23,80	31,70	47,50
337 L	33,8	857,25	90	8,70	12,30	15,80	23,80	31,70	47,50
345 L	34,5	876,30	92	8,70	12,30	15,80	23,80	31,70	47,50
360 L	36,0	914,40	96	9,50	12,70	16,40	24,80	33,00	49,30
367 L	36,7	933,45	98	9,50	12,70	16,40	24,80	33,00	49,30
375 L	37,5	952,50	100	10,00	13,60	17,50	26,40	35,10	52,70
382 L	38,2	971,55	102	10,00	13,60	17,50	26,40	35,10	52,70
390 L	39,0	990,60	104	10,00	13,60	17,50	26,40	35,10	52,70
394 L	39,4	1000,76	105	10,00	14,10	18,50	27,70	37,00	55,30
398 L	39,8	1010,92	106	10,00	14,10	18,50	27,70	37,00	55,30

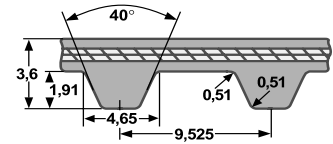

Type L - Teilung/ Pitch 9,525 mm

			Zoll/ inch mm	Breite/width 1/2 12,7	Breite/width 3/4 19,05	Breite/width 1 25,4	Breite/width 1 1/2 38,1	Breite/width 2 50,8	Breite/width 3 76,2
			Zoll/ inch	050	075	100	150	200	300
	Wirklänge pitch length		Zähne teeth	Stück piece Euro	Stück piece Euro	Stück piece Euro	Stück piece Euro	Stück piece Euro	Stück piece Euro
	Zoll/ inch	mm							
405 L	40,5	1028,70	108	10,00	14,10	18,50	27,70	37,00	55,30
420 L	42,0	1066,80	112	10,00	14,10	18,50	27,70	37,00	55,30
427 L	42,7	1084,58	114	10,40	15,10	19,60	29,20	39,30	58,20
436 L	43,6	1104,90	116	10,40	15,10	19,60	29,20	39,30	58,20
439 L	43,9	1114,43	117	10,40	15,10	19,60	29,20	39,30	58,20
446 L	44,6	1133,48	119	10,40	15,10	19,60	29,20	39,30	58,20
450 L	45,0	1143,00	120	10,40	15,10	19,60	29,20	39,30	58,20
454 L	45,4	1153,16	121	11,00	15,80	20,50	30,70	41,10	61,30
465 L	46,5	1181,10	124	11,00	15,80	20,50	30,70	41,10	61,30
480 L	48,0	1219,20	128	11,00	15,80	20,50	30,70	41,10	61,30
510 L	51,0	1295,40	136	11,10	16,20	21,20	30,70	42,30	63,30
514 L	51,4	1304,93	137	12,10	17,20	22,60	31,80	45,00	67,50
525 L	52,5	1333,50	140	12,10	17,20	22,60	34,70	45,00	67,50
540 L	54,0	1371,60	144	12,10	17,20	22,60	34,70	45,00	67,50
548 L	54,8	1390,65	146	12,90	18,80	24,40	34,70	48,90	73,40
581 L	58,1	1476,38	155	12,90	18,80	24,40	36,80	48,90	73,40
600 L	60,0	1524,00	160	12,90	18,80	24,40	36,80	48,90	73,40
605 L	60,5	1533,53	161	15,30	22,30	29,00	36,80	57,80	87,10
619 L	61,9	1571,63	165	15,30	22,30	29,00	43,50	57,80	87,10
630 L	63,0	1600,20	168	15,30	22,30	29,00	43,50	57,80	87,10
640 L	64,0	1619,25	170	15,30	22,30	29,00	43,50	57,80	87,10
653 L	65,3	1657,35	174	15,30	22,30	29,00	43,50	57,80	87,10
660 L	66,0	1676,40	176	15,30	22,30	29,00	43,50	57,80	87,10
697 L	69,7	1771,65	186	18,40	26,70	35,30	43,50	69,30	104,70
728 L	72,8	1847,85	194	18,40	26,70	35,30	52,10	69,30	104,70
731 L	73,1	1857,38	195	18,40	26,70	35,30	52,10	69,30	104,70
767 L	76,7	1952,63	205	18,40	26,70	35,30	52,10	69,30	104,70
780 L	78,0	1981,20	208	18,40	26,70	35,30	52,10	69,30	104,70
788 L	78,8	2000,25	210	18,40	26,70	35,30	52,10	69,30	104,70
806 L	80,6	2047,88	215	21,30	31,10	41,20	60,70	80,50	121,80
817 L	81,7	2075,18	218	21,30	31,10	41,20	60,70	80,50	121,80
855 L	85,5	2171,70	228	21,30	31,10	41,20	60,70	80,50	121,80
863 L	86,3	2190,75	230	21,30	31,10	41,20	60,70	80,50	121,80
881 L	88,1	2238,38	235	21,30	31,10	41,20	60,70	80,50	121,80
915 L	91,5	2324,10	244	21,30	31,10	41,20	60,70	80,50	121,80
919 L	91,9	2333,63	245	21,70	31,80	42,10	62,20	82,50	124,80
934 L	93,4	2372,36	249	21,70	31,80	42,10	62,20	82,50	124,80
938 L	93,8	2381,25	250	21,70	31,80	42,10	62,20	82,50	124,80
1294 L	129,4	3286,76	345	30,10	44,00	58,10	85,70	113,70	172,30

Wickelpreise auf Anfrage.

Prices of sleeves on request.

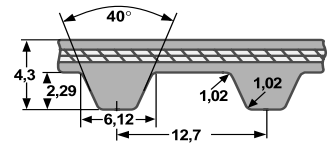

Type H - Teilung/ Pitch 12,7 mm

			Zoll inch	Breite/width	Breite/width	Breite/width	Breite/width	Breite/width	Breite/width	Breite/width
				$\frac{3}{4}$	1	1 1/2	2	3	4	5
			mm	19,05	25,4	38,1	50,8	76,2	101,6	127
			Zoll inch	075	100	150	200	300	400	500
	Wirklänge pitch length		Zähne teeth	Stück piece	Stück piece	Stück piece	Stück piece	Stück piece	Stück piece	Stück piece
	Zoll inch	mm								
185 H	18,5	469,9	37	9,90	12,40	18,10	23,80	34,80	49,00	61,30
225 H	22,5	571,5	45	10,90	13,80	20,20	26,30	38,70	54,40	68,10
230 H	23,0	584,2	46	10,90	13,80	20,20	26,30	38,70	54,40	68,10
240 H	24,0	609,6	48	10,90	13,80	20,20	26,30	38,70	54,40	68,10
245 H	24,5	622,3	49	11,70	15,10	21,70	28,60	41,80	59,90	75,20
255 H	25,5	647,7	51	11,70	15,10	21,70	28,60	41,80	59,90	75,20
270 H	27,0	685,8	54	11,70	15,10	21,70	28,60	41,80	59,90	75,20
280 H	28,0	711,2	56	12,50	16,20	23,60	30,70	45,10	64,90	80,10
300 H	30,0	762,0	60	12,50	16,20	23,60	30,70	45,10	64,90	80,10
310 H	31,0	787,4	62	13,20	17,30	25,00	33,00	48,40	68,70	86,00
315 H	31,5	800,1	63	13,20	17,30	25,00	33,00	48,40	68,70	86,00
320 H	32,0	812,8	64	13,20	17,30	25,00	33,00	48,40	68,70	86,00
330 H	33,0	838,2	66	13,20	17,30	25,00	33,00	48,40	68,70	86,00
340 H	34,0	863,6	68	14,00	18,40	26,60	35,10	51,80	74,10	91,00
350 H	35,0	889,0	70	14,00	18,40	26,60	35,10	51,80	74,10	91,00
360 H	36,0	914,4	72	14,00	18,40	26,60	35,10	51,80	74,10	91,00
370 H	37,0	939,8	74	15,00	19,40	28,20	36,70	55,10	77,90	97,00
375 H	37,5	952,5	75	15,00	19,40	28,20	36,70	55,10	77,90	97,00
390 H	39,0	990,6	78	15,00	19,40	28,20	36,70	55,10	77,90	97,00
400 H	40,0	1016,0	80	15,60	20,40	30,00	39,40	58,20	81,20	101,80
410 H	41,0	1041,4	82	15,60	20,40	30,00	39,40	58,20	81,20	101,80
420 H	42,0	1066,8	84	15,60	20,40	30,00	39,40	58,20	81,20	101,80
430 H	43,0	1092,2	86	16,60	21,60	31,60	42,40	61,60	86,00	107,60
450 H	45,0	1143,0	90	16,60	21,60	31,60	42,40	61,60	86,00	107,60
465 H	46,5	1181,1	93	17,40	22,60	33,30	44,50	65,40	89,90	112,90
480 H	48,0	1219,2	96	17,40	22,60	33,30	44,50	65,40	89,90	112,90
490 H	49,0	1244,6	98	17,80	23,70	34,30	46,00	67,00	94,70	118,30
510 H	51,0	1295,4	102	17,80	23,70	34,30	46,00	67,00	94,70	118,30
530 H	53,0	1346,2	106	18,90	24,90	36,50	48,90	70,80	99,20	124,20
540 H	54,0	1371,6	108	18,90	24,90	36,50	48,90	70,80	99,20	124,20
560 H	56,0	1422,4	112	19,70	25,60	37,70	50,30	74,10	101,80	128,10
565 H	56,5	1435,1	113	19,70	25,60	37,70	50,30	74,10	101,80	128,10
570 H	57,0	1447,8	114	19,70	25,60	37,70	50,30	74,10	101,80	128,10
580 H	58,0	1473,2	115	20,30	26,50	39,30	52,00	77,90	106,70	132,90
600 H	60,0	1524,0	120	20,30	26,50	39,30	52,00	77,90	106,70	132,90
605 H	60,5	1536,7	121	20,50	26,70	39,80	52,60	78,40	107,30	134,00
625 H	62,5	1587,5	125	20,50	26,70	39,80	52,60	78,40	107,30	134,00
630 H	63,0	1600,2	126	20,50	26,70	39,80	52,60	78,40	107,30	134,00
650 H	65,0	1651,0	130	21,10	27,60	41,40	55,10	82,20	110,00	137,30
660 H	66,0	1676,4	132	21,10	27,60	41,40	55,10	82,20	110,00	137,30
680 H	68,0	1727,2	136	22,20	29,00	43,50	57,70	87,10	116,60	144,90
700 H	70,0	1778,0	140	22,20	29,00	43,50	57,70	87,10	116,60	144,90
725 H	72,5	1841,5	145	23,10	30,40	45,60	61,00	91,00	121,60	152,50
730 H	73,0	1854,2	146	23,10	30,40	45,60	61,00	91,00	121,60	152,50
750 H	75,0	1905,0	150	23,10	30,40	45,60	61,00	91,00	121,60	152,50
760 H	76,0	1930,4	152	24,80	32,50	48,80	65,40	97,50	130,20	162,30
770 H	77,0	1955,8	154	24,80	32,50	48,80	65,40	97,50	130,20	162,30
800 H	80,0	2032,0	160	24,80	32,50	48,80	65,40	97,50	130,20	162,30
810 H	81,0	2057,4	162	25,90	33,80	50,70	67,60	101,20	135,10	168,40
820 H	82,0	2082,8	164	25,90	33,80	50,70	67,60	101,20	135,10	168,40
840 H	84,0	2133,6	168	25,90	33,80	50,70	67,60	101,20	135,10	168,40
850 H	85,0	2159,0	170	25,90	33,80	50,70	67,60	101,20	135,10	168,40
860 H	86,0	2184,4	172	27,40	36,00	54,00	71,40	107,90	143,80	179,70
880 H	88,0	2235,2	176	27,40	36,00	54,00	71,40	107,90	143,80	179,70
900 H	90,0	2286,0	180	27,40	36,00	54,00	71,40	107,90	143,80	179,70
950 H	95,0	2413,0	190	30,10	39,30	58,90	78,40	118,30	157,40	196,70
985 H	98,5	2501,9	197	30,10	39,30	58,90	78,40	118,30	157,40	196,70

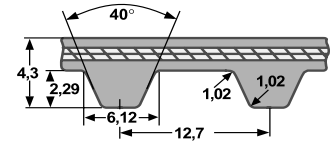

Type H - Teilung/ Pitch 12,7 mm

			Zoll inch	Breite/width	Breite/width	Breite/width	Breite/width	Breite/width	Breite/width	Breite/width
				¾	1	1 1/2	2	3	4	5
			mm	19,05	25,4	38,1	50,8	76,2	101,6	127
			Zoll inch	075	100	150	200	300	400	500
	Wirklänge pitch length		Zähne teeth	Stück piece	Stück piece	Stück piece	Stück piece	Stück piece	Stück piece	Stück piece
	Zoll inch	mm								
1000 H	100	2540,0	200	30,10	39,30	58,90	78,40	118,30	157,40	196,70
1020 H	102	2590,8	204	32,50	42,60	64,30	85,50	128,10	170,00	213,00
1050 H	105	2667,0	210	32,50	42,60	64,30	85,50	128,10	170,00	213,00
1100 H	110	2794,0	220	32,50	42,60	64,30	85,50	128,10	170,00	213,00
1120 H	112	2844,8	224	36,50	48,00	71,40	95,90	144,40	191,70	240,30
1130 H	113	2870,4	226	36,50	48,00	71,40	95,90	144,40	191,70	240,30
1140 H	114	2895,6	228	36,50	48,00	71,40	95,90	144,40	191,70	240,30
1245 H	124,5	3162,3	249	36,50	48,00	71,40	95,90	144,40	191,70	240,30
1250 H	125	3175,0	250	36,50	48,00	71,40	95,90	144,40	191,70	240,30
1325 H	132,5	3365,5	265	39,90	53,20	79,50	106,70	159,00	212,50	265,90
1350 H	135	3429,0	270	39,90	53,20	79,50	106,70	159,00	212,50	265,90
1360 H	136	3454,4	272	39,90	53,20	79,50	106,70	159,00	212,50	265,90
1400 H	140	3556,0	280	39,90	53,20	79,50	106,70	159,00	212,50	265,90
1700 H	170	4318,0	340	48,20	63,10	95,40	127,40	190,10	253,90	318,20

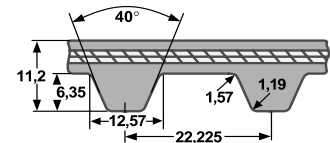

Type XH - Teilung/ Pitch 22,225 mm

			Zoll inch	Breite/width	Breite/width	Breite/width	Breite/width	Breite/width	Breite/width
				2	3	4	5	6	7
			mm	50,8	76,2	101,6	127,0	152,4	177,8
			Zoll inch	200	300	400	500	600	700
	Wirklänge pitch length		Zähne teeth	Stück piece	Stück piece	Stück piece	Stück piece	Stück piece	Stück piece
	Zoll inch	mm							
463 XH	46,3	1176,0	53	98,00	147,00	196,60	245,10	293,90	343,50
507 XH	50,0	1289,0	58	98,00	147,00	196,60	245,10	293,90	343,50
534 XH	53,4	1356,4	61	104,60	156,90	209,10	260,50	313,30	365,50
560 XH	56,0	1422,4	64	104,60	156,90	209,10	260,50	313,30	365,50
630 XH	63,0	1600,2	72	110,70	166,20	220,80	276,90	332,50	387,50
700 XH	70,0	1778,0	80	119,50	178,30	237,90	297,90	357,30	416,10
735 XH	73,5	1866,9	84	125,00	188,30	250,50	313,30	376,10	438,20
770 XH	77,0	1955,8	88	125,00	188,30	250,50	313,30	376,10	438,20
840 XH	84,0	2133,6	96	133,80	200,40	266,00	334,20	400,70	467,30
875 XH	87,5	2222,5	100	148,10	223,40	297,30	371,60	445,90	520,80
927 XH	92,7	2355,9	106	148,10	223,40	297,30	371,60	445,90	520,80
980 XH	98,0	2489,2	112	148,10	223,40	297,30	371,60	445,90	520,80
1120 XH	112	2844,8	128	160,80	241,70	322,50	402,90	483,30	563,80
1260 XH	126	3200,4	144	181,60	271,50	362,70	454,20	544,50	634,70
1400 XH	140	3556,0	160	198,20	296,70	395,30	494,40	593,40	692,40
1540 XH	154	3911,6	176	209,10	312,60	416,70	521,90	625,90	729,40
1640 XH	164	4165,6	187	235,60	353,50	471,10	589,00	706,80	824,00
1750 XH	175	4445,0	200	235,60	353,50	471,10	589,00	706,80	824,00
Wickelpreise auf Anfrage.									
Prices of sleeves on request.									

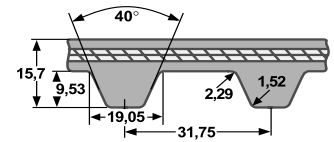

Type XXH - Teilung/ Pitch 31,75 mm

			Zoll inch	Breite/width	Breite/width	Breite/width	Breite/width
				2	3	4	5
			mm	50,8	76,2	101,6	127
			Zoll inch	200	300	400	500
			mm	200	300	400	500
	Wirklänge pitch length		Zähne teeth	Stück piece	Stück piece	Stück piece	Stück piece
	Zoll inch	mm					
700 XXH	70	1778,0	56	244,30	378,10	504,90	664,30
800 XXH	80	2032,0	64	273,10	421,70	563,30	739,00
900 XXH	90	2286,0	72	301,70	465,40	621,30	813,60
1000 XXH	100	2540,0	80	329,70	509,70	679,80	888,30
1200 XXH	120	3048,0	96	390,60	601,60	803,50	1014,40
1400 XXH	140	3556,0	112	446,20	679,20	904,40	1129,60
1600 XXH	160	4064,0	128	513,30	786,80	1022,70	1295,70
1800 XXH	180	4572,0	144	571,00	876,80	1123,60	1417,60
1915 XXH	191,5	4857,8	153	572,70	931,70	1193,90	1506,20

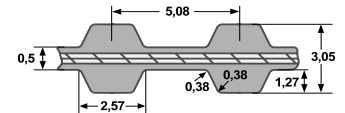

Type DXL - Teilung/ Pitch 5,08 mm doppelt gezahnt/ double toothed

			Zoll inch	Breite/width	Breite/width	Breite/width
				¼	5/16	3/8
			mm	6,35	7,94	9,53
			Zoll inch	025	031	037
			mm	025	031	037
	Wirklänge pitch length		Zähne teeth	Stück piece	Stück piece	Stück piece
	Zoll inch	mm				
120 DXL	12,0	304,80	60	6,40	10,60	12,20
130 DXL	13,0	330,20	65	6,80	10,60	12,20
140 DXL	14,0	355,60	70	7,30	10,60	12,20
150 DXL	15,0	381,00	75	7,70	10,60	12,20
152 DXL	15,2	386,08	76	9,70	10,60	12,20
154 DXL	15,4	391,16	77	9,70	10,60	12,20
156 DXL	15,6	196,24	78	9,70	10,60	12,20
160 DXL	16,0	406,40	80	9,70	10,60	12,20
162 DXL	16,2	411,48	81	9,90	10,90	12,40
164 DXL	16,4	416,66	82	9,90	10,90	12,40
166 DXL	16,6	421,64	83	9,90	10,90	12,40
168 DXL	16,8	426,72	84	9,90	10,90	12,40
170 DXL	17,0	431,80	85	9,90	10,90	12,40
172 DXL	17,2	436,88	86	10,00	11,50	12,50
174 DXL	17,4	441,96	87	10,00	11,50	12,50
176 DXL	17,6	447,04	88	10,00	11,50	12,50
178 DXL	17,8	452,12	89	10,00	11,50	12,50
180 DXL	18,0	457,20	90	10,00	11,50	12,50
182 DXL	18,2	462,28	91	10,20	11,60	13,00
184 DXL	18,4	467,36	92	10,20	11,60	13,00
188 DXL	18,8	477,52	94	10,20	11,60	13,00
190 DXL	19,0	482,60	95	10,20	11,60	13,00
194 DXL	19,4	492,78	97	10,50	11,80	13,50
196 DXL	19,6	497,84	98	10,50	11,80	13,50
198 DXL	19,8	502,92	99	10,50	11,80	13,50
200 DXL	20,0	508,00	100	10,50	11,80	13,50
202 DXL	20,2	513,08	101	10,60	11,90	13,60
204 DXL	20,4	518,16	102	10,60	11,90	13,60
206 DXL	20,6	523,24	103	10,60	11,90	13,60
208 DXL	20,8	528,32	104	10,60	11,90	13,60
210 DXL	21,0	533,40	105	10,60	11,90	13,60
212 DXL	21,2	538,48	106	10,90	12,20	14,00

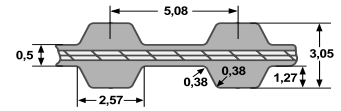

Type DXL - Teilung/ Pitch 5,08 mm

		Zoll/ inch mm Zoll/ inch	Breite/width ¼ 6,35 025	Breite/width 5/16 7,94 031	Breite/width 3/8 9,53 037	
	Wirklänge pitch length		Zähne teeth	Stück piece Euro	Stück piece Euro	Stück piece Euro
	Zoll/ inch	mm				
214 DXL	21,4	543,56	107	10,90	12,20	14,00
220 DXL	22,0	558,80	110	10,90	12,20	14,00
224 DXL	22,4	568,96	112	11,50	12,40	14,10
228 DXL	22,8	579,12	114	11,50	12,40	14,10
230 DXL	23,0	584,20	115	11,50	12,40	14,10
234 DXL	23,4	594,36	117	11,80	13,00	14,90
240 DXL	24,0	609,60	120	11,80	13,00	14,90
248 DXL	24,8	629,92	124	11,80	13,00	14,90
250 DXL	25,0	635,00	125	11,80	13,00	14,90
254 DXL	25,4	645,16	127	11,90	13,20	15,30
260 DXL	26,0	660,40	130	11,90	13,20	15,30
262 DXL	26,2	665,48	131	12,20	13,60	15,60
266 DXL	26,6	675,64	133	12,20	13,60	15,60
270 DXL	27,0	685,80	135	12,20	13,60	15,60
276 DXL	27,6	701,04	139	12,40	13,80	15,80
280 DXL	28,0	711,20	140	12,40	13,80	15,80
282 DXL	28,2	716,28	141	12,50	14,00	16,00
290 DXL	29,0	736,60	145	12,50	14,00	16,00
300 DXL	30,0	762,00	150	13,00	14,10	16,40
310 DXL	31,0	787,40	155	14,50	15,90	18,40
314 DXL	31,4	797,56	157	14,70	16,10	18,60
316 DXL	31,6	802,64	158	14,70	16,20	18,70
320 DXL	32,0	812,80	160	15,00	16,30	18,90
322 DXL	32,2	817,88	161	15,10	16,40	19,00
330 DXL	33,0	838,20	165	15,40	16,90	19,60
340 DXL	34,0	863,60	170	15,90	17,40	20,20
344 DXL	34,4	873,76	172	16,10	17,60	20,40
348 DXL	34,8	883,92	174	16,30	17,80	20,60
352 DXL	35,2	894,24	176	16,40	18,00	20,90
356 DXL	35,6	904,24	178	16,70	18,10	21,10
360 DXL	36,0	914,40	180	16,90	18,50	21,30
364 DXL	36,4	924,56	182	17,10	18,70	21,50
370 DXL	37,0	939,80	185	17,30	19,00	21,90
372 DXL	37,2	944,88	186	17,40	19,00	22,00
376 DXL	37,6	955,04	188	17,60	19,20	22,30
380 DXL	38,0	965,20	190	17,70	19,40	22,50
384 DXL	38,4	975,36	192	17,90	19,70	22,70
388 DXL	38,8	985,52	194	18,10	19,90	22,90
390 DXL	39,0	990,60	195	18,10	19,90	22,00
392 DXL	39,2	995,68	196	18,40	20,10	23,10
396 DXL	39,6	1005,84	198	18,60	20,30	23,40
400 DXL	40,0	1016,00	200	18,70	20,50	23,70
408 DXL	40,8	1036,32	204	19,10	21,00	24,10
424 DXL	42,4	1076,96	212	19,80	21,70	25,10
430 DXL	43,0	1092,29	215	20,20	22,00	25,40
434 DXL	43,4	1102,36	217	20,30	22,30	25,70
450 DXL	45,0	1143,00	225	21,10	23,00	26,60
456 DXL	45,6	1158,24	228	21,30	23,20	26,90
460 DXL	46,0	1168,40	230	21,50	23,60	27,30
470 DXL	47,0	1193,80	235	22,00	24,10	27,80
490 DXL	49,0	1244,60	245	22,90	25,10	29,00
496 DXL	49,6	1259,84	248	23,10	25,40	29,30
510 DXL	51,0	1295,40	255	23,90	26,20	30,10
530 DXL	53,0	1346,20	265	24,80	27,20	31,40
540 DXL	54,0	1371,60	270	25,20	27,70	31,90
564 DXL	56,4	1432,56	282	26,40	28,90	33,30
592 DXL	59,2	1503,68	296	27,70	30,30	35,00
600 DXL	60,0	1524,00	300	28,10	30,70	35,40
608 DXL	60,8	1544,32	304	28,50	31,20	36,00
630 DXL	63,0	1600,20	315	29,40	32,40	37,20

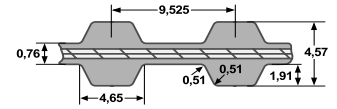

Type DL - Teilung/ Pitch 9,525 mm

		Zoll/ inch mm	Zoll/ inch	Breite/width		
				1/2 12,7 050	¾ 19,05 075	1 25,4 100
	Wirklänge pitch length		Zähne teeth	Stück piece Euro	Stück piece Euro	Stück piece Euro
	Zoll/ inch	mm				
124 DL	12,4	314,96	33	22,40	31,10	39,60
135 DL	13,5	342,90	36	22,40	31,10	39,60
150 DL	15,0	381,00	40	22,40	31,10	39,60
165 DL	16,5	419,10	44	22,40	31,10	39,60
169 DL	16,9	428,63	45	22,40	31,10	39,60
172 DL	17,2	438,15	46	22,40	31,10	39,60
173 DL	17,3	439,42	43	22,40	31,10	39,60
187 DL	18,7	476,20	50	22,40	31,10	39,60
202 DL	20,2	513,08	54	24,10	33,70	43,20
203 DL	20,3	514,35	54	24,10	33,70	43,20
210 DL	21,0	533,40	56	24,10	33,70	43,20
218 DL	21,8	553,72	58	24,40	34,50	44,30
225 DL	22,5	571,50	60	24,40	34,50	44,30
232 DL	23,2	589,28	62	26,20	36,70	47,00
240 DL	24,0	609,60	64	26,20	36,70	47,00
248 DL	24,8	629,92	66	26,90	37,30	48,20
255 DL	25,5	647,70	68	26,90	37,30	48,20
263 DL	26,3	666,75	70	27,90	39,10	50,50
265 DL	26,5	673,10	71	27,90	39,10	50,50
270 DL	27,0	685,80	72	27,90	39,10	50,50
277 DL	27,7	704,85	74	28,20	40,30	52,20
285 DL	28,5	723,90	76	28,20	40,30	52,20
300 DL	30,0	762,00	80	30,30	41,50	54,30
304 DL	30,4	771,53	81	31,10	43,60	57,40
315 DL	31,5	800,10	84	31,10	43,60	57,40
320 DL	32,0	809,63	85	31,10	43,60	57,40
322 DL	32,2	819,10	86	31,10	43,60	57,40
334 DL	33,4	847,73	89	32,50	46,00	59,10
337 DL	33,7	857,25	90	32,50	46,00	59,10
345 DL	34,5	876,30	92	32,50	46,00	59,10
360 DL	36,0	914,40	96	33,60	47,50	61,50
367 DL	36,7	933,40	98	33,60	47,50	61,50
375 DL	37,5	952,50	100	35,10	50,40	65,60
382 DL	38,2	971,55	102	35,10	50,40	65,60
390 DL	39,0	990,60	104	35,10	50,40	65,60
394 DL	39,4	1000,76	105	37,30	53,00	69,00
405 DL	40,5	1028,70	108	37,30	53,00	69,00
412 DL	41,2	1046,48	110	37,30	53,00	69,00
420 DL	42,0	1066,80	112	37,30	53,00	69,00
427 DL	42,7	1085,85	114	39,10	56,30	73,00
435 DL	43,5	1104,90	116	39,10	56,30	73,00
436 DL	43,6	1107,44	116	39,10	56,30	73,00
439 DL	43,9	1114,43	117	39,10	56,30	73,00
446 DL	44,6	1133,48	119	39,10	56,30	73,00
450 DL	45,0	1143,00	120	39,10	56,30	73,00
454 DL	45,4	1153,16	121	41,20	58,80	76,90
465 DL	46,5	1181,10	124	41,20	58,80	76,90
480 DL	48,0	1219,20	128	41,20	58,80	76,90
510 DL	51,0	1295,40	136	41,50	60,80	79,10
514 DL	51,4	1304,93	137	45,00	63,90	84,30
525 DL	52,5	1333,50	140	45,00	63,90	84,30
540 DL	54,0	1371,60	144	45,00	63,90	84,30
548 DL	54,8	1390,65	146	48,70	69,80	91,70
550 DL	55,0	1397,00	147	48,70	69,80	91,70
581 DL	58,1	1476,38	155	48,70	69,80	91,70
600 DL	60,0	1524,00	160	48,70	69,80	91,70
605 DL	60,5	1533,53	161	52,40	76,00	99,10
619 DL	61,9	1571,63	165	52,40	76,00	99,10
630 DL	63,0	1600,20	168	52,40	76,00	99,10
640 DL	64,0	1619,25	170	55,10	79,60	104,20

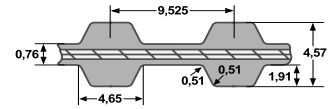

Type DL - Teilung/ Pitch 9,525 mm

			Zoll/ inch mm	Breite/width		Breite/width		Breite/width	
			Zoll/ inch	1/2 12,7	3/4 19,05	1 25,4			
Wirklänge pitch length			Zähne teeth	Stück piece	Stück piece	Stück piece		Stück piece	
Zoll/ inch mm			Euro	Euro	Euro		Euro		
653 DL	65,3	1657,35	174	55,10	79,60	104,20			
660 DL	66,0	1676,40	176	55,10	79,60	104,20			
697 DL	69,7	1771,65	186	60,90	88,20	115,40			
728 DL	72,8	1847,85	194	60,90	88,20	115,40			
731 DL	73,1	1857,38	195	60,90	88,20	115,40			
767 DL	76,7	1952,63	205	65,70	95,00	124,20			
780 DL	78,0	1981,20	208	65,70	95,00	124,20			
788 DL	78,8	2000,25	210	65,70	95,00	124,20			
806 DL	80,6	2047,88	215	71,30	103,10	134,80			
817 DL	81,7	2075,18	218	71,30	103,10	134,80			
855 DL	85,5	2171,70	228	71,30	103,10	134,80			
863 DL	86,3	2190,75	230	76,40	110,30	136,10			
881 DL	88,1	2238,38	235	76,40	110,30	136,10			
915 DL	91,5	2324,10	244	76,40	110,30	136,10			
919 DL	91,9	2333,63	245	78,20	113,10	147,90			
938 DL	93,8	2381,25	250	78,20	113,10	147,90			
1294 DL	129,4	3286,76	345	107,90	156,00	204,10			

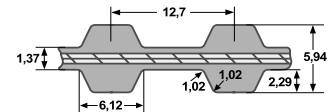

Type DH - Teilung/ Pitch 12,7 mm

			Zoll/ inch mm	Breite/width		Breite/width		Breite/width	
			Zoll/ inch	3/4 19,05	1 25,4	1 1/2 38,1	2 50,8	3 76,2	
Wirklänge pitch length			Zähne teeth	Stück piece	Stück piece	Stück piece	Stück piece	Stück piece	
Zoll/ inch mm			Euro	Euro	Euro		Euro		
185 DH	18,5	469,90	37	38,50	48,40	71,10	93,00	136,30	
225 DH	22,5	571,50	45	38,50	48,40	71,10	93,00	136,30	
230 DH	23,0	584,20	46	38,50	48,40	71,10	93,00	136,30	
240 DH	24,0	609,60	48	38,50	48,40	71,10	93,00	136,30	
245 DH	24,5	622,30	49	41,30	53,00	76,80	100,90	147,50	
255 DH	25,5	647,70	51	41,30	53,00	76,80	100,90	147,50	
270 DH	27,0	685,80	54	41,30	53,00	76,80	100,90	147,50	
280 DH	28,0	711,20	56	44,00	58,10	82,50	108,20	159,00	
300 DH	30,0	762,00	60	44,00	58,10	82,50	108,20	159,00	
310 DH	31,0	787,40	62	46,70	61,00	88,40	116,20	170,80	
315 DH	31,5	800,10	63	46,70	61,00	88,40	116,20	170,80	
320 DH	32,0	812,80	64	46,70	61,00	88,40	116,20	170,80	
330 DH	33,0	838,20	66	46,70	61,00	88,40	116,20	170,80	
340 DH	34,0	863,60	68	49,50	64,50	94,40	123,70	182,50	
350 DH	35,0	889,00	70	49,50	64,50	94,40	123,70	182,50	
360 DH	36,0	914,40	72	49,50	64,50	94,40	123,70	182,50	
370 DH	37,0	939,80	74	52,60	68,90	99,50	129,50	194,00	
375 DH	37,5	952,50	75	52,60	68,90	99,50	129,50	194,00	
390 DH	39,0	990,60	78	52,60	68,90	99,50	129,50	194,00	
400 DH	40,0	1016,00	80	55,30	71,80	105,80	138,90	205,50	
410 DH	41,0	1041,40	82	55,30	71,80	105,80	138,90	205,50	
420 DH	42,0	1066,80	84	55,30	71,80	105,80	138,90	205,50	
430 DH	43,0	1092,20	86	58,70	76,40	111,50	149,40	217,10	
450 DH	45,0	1143,00	90	58,70	76,40	111,50	149,40	217,10	
465 DH	46,5	1181,10	93	61,30	79,60	117,30	157,10	230,50	
480 DH	48,0	1219,20	96	61,30	79,60	117,30	157,10	230,50	
490 DH	49,0	1244,60	98	63,00	83,20	121,00	162,30	236,40	
510 DH	51,0	1295,40	102	63,00	83,20	121,00	162,30	236,40	

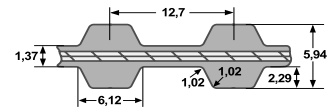

Type DH - Teilung/ Pitch 12,7 mm

	Zoll/ inch mm Zoll/ inch		Breite/width ¾	Breite/width 1	Breite/width 1 1/2	Breite/width 2	Breite/width 3	
								19,05 075
	Wirklänge pitch length		Zähne teeth	Stück piece Euro	Stück piece Euro	Stück piece Euro	Stück piece Euro	Stück piece Euro
	Zoll/ inch	mm						
530 DH	53,0	1346,20	106	66,80	88,10	128,60	172,30	249,70
540 DH	54,0	1371,60	108	66,80	88,10	128,60	172,30	249,70
560 DH	56,0	1422,40	112	69,40	90,20	132,70	177,20	261,20
565 DH	56,5	1435,10	113	69,40	90,20	132,70	177,20	261,20
570 DH	57,0	1447,80	114	69,40	90,20	132,70	177,20	261,20
580 DH	58,0	1473,20	116	71,50	93,50	138,70	183,60	274,70
600 DH	60,0	1524,00	120	71,50	93,50	138,70	183,60	274,70
605 DH	60,5	1536,70	121	72,20	94,30	140,50	185,70	276,70
625 DH	62,5	1587,50	125	72,20	94,30	140,50	185,70	276,70
630 DH	63,0	1600,20	126	72,20	94,30	140,50	185,70	276,70
650 DH	65,0	1651,00	130	74,50	97,20	145,80	194,00	290,10
660 DH	66,0	1676,40	132	74,50	97,20	145,80	194,00	290,10
680 DH	68,0	1727,20	136	78,10	102,10	153,20	203,70	307,30
700 DH	70,0	1778,00	140	78,10	102,10	153,20	203,70	307,30
725 DH	72,5	1841,50	145	81,70	107,60	160,80	215,20	320,80
730 DH	73,0	1854,20	146	81,70	107,60	160,80	215,20	320,80
750 DH	75,0	1905,00	150	81,70	107,60	160,80	215,20	320,80
760 DH	76,0	1930,40	152	87,30	114,40	172,00	230,50	343,80
770 DH	77,0	1955,80	154	87,30	114,40	172,00	230,50	343,80
800 DH	80,0	2032,00	160	87,30	114,40	172,00	230,50	343,80
810 DH	81,0	2057,40	162	90,80	119,40	178,90	238,20	357,30
820 DH	82,0	2082,80	164	90,80	119,40	178,90	238,20	357,30
840 DH	84,0	2133,60	168	90,80	119,40	178,90	238,20	357,30
850 DH	85,0	2159,00	170	90,80	119,40	178,90	238,20	357,30
860 DH	86,0	2184,40	172	96,60	126,80	190,30	251,60	380,30
880 DH	88,0	2235,20	176	96,60	126,80	190,30	251,60	380,30
900 DH	90,0	2286,00	180	96,60	126,80	190,30	251,60	380,30
950 DH	95,0	2413,00	190	106,10	138,70	207,50	276,70	416,80
985 DH	98,5	2501,90	197	106,10	138,70	207,50	276,70	416,80
1000 DH	100,0	2540,00	200	106,10	150,30	207,50	276,70	416,80
1020 DH	102,0	2590,80	204	114,40	150,30	226,60	301,50	451,50
1050 DH	105,0	2667,00	210	114,40	150,30	226,60	301,50	451,50
1100 DH	110,0	2794,00	220	114,40	150,30	226,60	301,50	451,50
1120 DH	112,0	2844,80	224	128,60	169,20	251,60	338,00	509,00
1130 DH	113,0	2870,20	226	128,60	169,20	251,60	338,00	509,00
1140 DH	114,0	2895,60	228	128,60	169,20	251,60	338,00	509,00
1150 DH	115,0	2921,00	230	128,60	169,20	251,60	338,00	509,00
1250 DH	125,0	3175,00	250	128,60	169,20	251,60	338,00	509,00
1325 DH	125,0	3175,00	250	128,60	169,20	251,60	338,00	509,00
1350 DH	135,0	3429,00	270	140,30	187,40	280,50	376,50	560,90
1400 DH	140,0	3556,00	280	140,30	187,40	280,50	376,50	560,90
1700 DH	170,0	4318,00	340	170,10	222,90	336,20	449,50	670,40

Wickelpreise auf Anfrage.

Prices of sleeves on request.

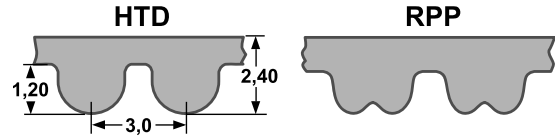

Type 3M - Teilung/ Pitch 3 mm

Größe size	Wirklänge pitch length mm	Zähnezahl number of teeth	Breite width	Breite width	Breite width
			6 mm	9 mm	15 mm
			Stück/ piece Euro	Stück/ piece Euro	Stück/ piece Euro
105-3M	105	35	2,50	3,30	5,10
120-3M	120	40	2,90	3,80	5,40
129-3M	129	43	2,90	3,80	5,40
144-3M	144	48	2,90	3,80	5,40
150-3M	150	50	3,10	3,80	5,50
159-3M	159	53	3,10	4,00	5,70
168-3M	168	56	3,10	4,00	5,80
177-3M	177	59	3,10	4,00	5,80
180-3M	180	60	3,10	4,00	5,80
195-3M	195	65	3,10	4,00	5,80
201-3M	201	67	3,10	4,00	5,90
204-3M	204	68	3,10	4,00	5,90
210-3M	210	70	3,10	4,00	5,90
213-3M	213	71	3,10	4,00	5,90
225-3M	225	75	3,10	4,00	6,00
243-3M	243	81	3,10	4,00	6,00
246-3M	246	82	3,10	4,00	6,00
252-3M	252	84	3,10	4,00	6,00
255-3M	255	85	3,30	4,20	6,20
267-3M	267	89	3,30	4,20	6,20
285-3M	285	95	3,40	4,20	6,20
288-3M	288	96	3,40	4,20	6,20
300-3M	300	100	3,40	4,30	6,40
312-3M	312	104	3,40	4,30	6,50
318-3M	318	106	3,40	4,30	6,60
330-3M	330	110	3,50	4,60	6,70
333-3M	333	111	3,50	4,60	6,70
336-3M	336	112	3,50	4,60	6,70
339-3M	339	113	3,50	4,60	6,70
384-3M	384	128	3,60	4,70	7,00
390-3M	390	130	3,60	4,70	7,00
420-3M	420	140	3,70	4,70	7,10
447-3M	447	149	3,80	4,90	7,10
474-3M	474	158	3,80	5,00	7,20
480-3M	480	160	3,80	5,00	7,20
486-3M	486	162	3,80	5,00	7,30
501-3M	501	167	3,80	5,00	7,50
513-3M	513	171	3,80	5,00	7,50
522-3M	522	174	3,80	5,00	7,60
525-3M	525	175	3,80	5,00	7,60
531-3M	531	177	4,00	5,00	7,60
537-3M	537	179	4,00	5,10	7,70
564-3M	564	188	4,00	5,10	7,70
570-3M	570	190	4,00	5,20	7,90
597-3M	597	199	4,00	5,20	7,90
633-3M	633	211	4,20	5,40	8,00
669-3M	669	223	4,30	5,70	8,40
711-3M	711	237	4,60	5,80	8,70
804-3M	804	268	4,90	6,20	9,20
882-3M	882	294	4,90	6,20	9,20
945-3M	945	315	5,00	6,40	9,50
1062-3M	1062	354	5,20	6,80	10,00
1071-3M	1071	357	5,20	6,80	10,00
1080-3M	1080	360	5,40	7,00	10,40
1125-3M	1125	375	5,40	7,00	10,40
1245-3M	1245	415	5,70	7,30	10,90
1263-3M	1263	421	5,70	7,30	10,90
1500-3M	1500	500	5,80	7,60	11,10
1530-3M	1530	510	5,80	7,60	11,10
1863-3M	1863	621	7,20	9,40	13,80
1926-3M	1926	642	7,50	9,80	14,30

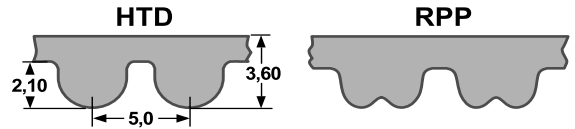

Type 5M Teilung/ Pitch 5 mm

Größe size	Wirklänge pitch length mm	Zähnezahl number of teeth	Breite width	Breite width	Breite width
			9 mm	15 mm	25 mm
			Stück/ piece Euro	Stück/ piece Euro	Stück/ piece Euro
120-5M	120	24	3,50	4,90	7,00
180-5M	180	36	3,70	5,40	7,90
225-5M	225	45	3,90	5,90	8,60
235-5M	235	47	3,90	5,90	8,70
245-5M	245	49	3,90	6,00	8,90
255-5M	255	51	3,90	6,00	9,00
265-5M	265	53	4,10	6,00	9,00
270-5M	270	54	4,20	6,20	9,00
275-5M	275	55	4,20	6,30	9,20
280-5M	280	56	4,20	6,30	9,20
295-5M	295	59	4,20	6,30	9,30
300-5M	300	60	4,20	6,40	9,50
305-5M	305	61	4,30	6,50	9,50
325-5M	325	65	4,60	6,70	9,80
330-5M	330	66	4,60	6,70	9,80
335-5M	335	67	4,60	6,70	9,90
340-5M	340	68	4,60	6,70	9,90
345-5M	345	69	4,60	6,70	10,00
350-5M	350	70	4,60	6,70	10,00
360-5M	360	72	4,70	6,80	10,30
365-5M	365	73	4,70	6,80	10,30
370-5M	370	74	4,70	6,80	10,30
375-5M	375	75	4,70	6,80	10,30
400-5M	400	80	4,90	7,00	10,50
420-5M	420	84	5,00	7,10	10,80
425-5M	425	85	5,00	7,10	10,80
450-5M	450	90	5,70	8,10	12,20
455-5M	455	91	5,70	8,10	12,20
460-5M	460	92	5,70	8,30	12,30
465-5M	465	93	5,80	8,30	12,30
475-5M	475	95	5,80	8,40	12,30
500-5M	500	100	5,80	8,70	12,60
520-5M	520	104	6,00	8,90	13,20
525-5M	525	105	6,00	8,90	13,20
535-5M	535	107	6,00	8,90	13,20
550-5M	550	110	6,00	8,90	13,20
560-5M	560	112	6,00	9,00	13,60
565-5M	565	113	6,00	9,00	13,60
575-5M	575	115	6,20	9,20	13,80
580-5M	580	116	6,20	9,20	13,80
600-5M	600	120	6,30	9,50	14,10
610-5M	610	122	6,40	9,70	14,30
615-5M	615	123	6,40	9,80	14,30
635-5M	635	127	6,60	9,90	14,60
640-5M	640	128	6,70	10,00	14,90
645-5M	645	129	6,70	10,00	14,90
665-5M	665	133	6,70	10,10	15,00
670-5M	670	134	6,70	10,10	15,00
675-5M	675	135	7,00	10,30	15,30
695-5M	695	139	7,00	10,30	15,30
700-5M	700	140	7,00	10,30	15,30
705-5M	705	141	7,00	10,30	15,30
710-5M	710	142	7,00	10,30	15,30
720-5M	720	144	7,00	10,50	15,50
725-5M	725	145	7,00	10,50	15,50
740-5M	740	148	7,00	10,50	15,50
750-5M	750	150	7,10	10,60	15,80
755-5M	755	151	7,10	10,60	15,80
770-5M	770	154	7,40	11,20	16,70
775-5M	775	155	7,40	11,20	16,70
800-5M	800	160	7,40	11,20	16,70

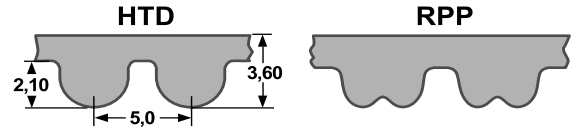

Type 5M Teilung/ Pitch 5 mm

Größe size	Wirklänge pitch length mm	Zähnezahl number of teeth	Breite width	Breite width	Breite width
			9 mm	15 mm	25 mm
			Stück/ piece	Stück/ piece	Stück/ piece
			Euro	Euro	Euro
825-5M	825	165	7,50	11,50	17,30
835-5M	835	167	7,60	11,50	17,30
850-5M	850	170	7,70	11,60	17,50
860-5M	860	172	7,70	11,60	17,50
870-5M	870	174	7,90	11,80	17,50
890-5M	890	178	7,90	11,80	17,50
900-5M	900	180	7,90	11,80	17,60
935-5M	935	187	8,10	12,20	18,00
940-5M	940	188	8,30	12,20	18,00
950-5M	950	190	8,30	12,20	18,00
965-5M	965	193	8,40	12,30	18,40
980-5M	980	196	8,40	12,60	18,50
1000-5M	1000	200	8,40	12,60	18,80
1025-5M	1025	205	8,60	12,80	19,20
1035-5M	1035	207	8,60	12,80	19,20
1050-5M	1050	210	8,80	12,90	19,30
1100-5M	1100	220	8,80	13,60	19,90
1125-5M	1125	225	9,10	13,60	20,30
1135-5M	1135	227	9,30	13,80	20,50
1175-5M	1175	235	9,50	14,00	20,90
1195-5M	1195	239	9,70	14,20	21,20
1200-5M	1200	240	9,70	14,20	21,30
1225-5M	1225	245	9,80	14,30	21,40
1240-5M	1240	248	9,80	14,50	21,60
1270-5M	1270	254	9,90	14,60	21,90
1350-5M	1350	270	10,60	15,80	23,60
1420-5M	1420	284	10,80	16,00	23,80
1595-5M	1595	319	11,70	17,30	25,70
1690-5M	1690	338	12,10	17,80	26,60
1790-5M	1790	358	12,70	18,90	28,10
1800-5M	1800	360	12,70	18,90	28,40
1870-5M	1870	374	13,00	19,30	28,90
1895-5M	1895	379	13,40	19,80	29,40
2000-5M	2000	400	13,90	20,50	30,70
2100-5M	2100	420	14,60	22,20	32,30
2250-5M	2250	450	15,60	23,40	34,50
2350-5M	2350	470	16,20	24,40	36,10
2525-5M	2525	505	16,70	24,80	36,80

Wickelpreise auf Anfrage.
Prices of sleeves on request.

Abmessungen in Fettdruck nur in RPP verfügbar.
Bold-faced dimensions only available in RPP.

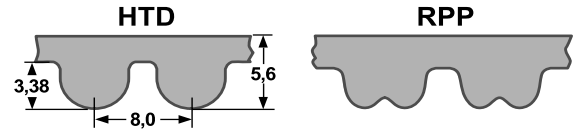

Type 8M - Teilung/ Pitch 8 mm

Größe size	Wirklänge pitch length mm	Zahnezahl number of teeth	Breite width	Breite width	Breite width	Breite width
			20 mm	30 mm	50 mm	85 mm
			Stück/ piece Euro	Stück/ piece Euro	Stück/ piece Euro	Stück/ piece Euro
320-8M	320	40	8,60	12,70	21,00	34,20
352-8M	352	44	8,90	13,60	22,40	38,50
376-8M	376	47	8,90	13,60	22,40	38,50
384-8M	384	48	9,20	13,90	23,00	39,50
408-8M	408	51	9,50	14,20	23,60	40,30
424-8M	424	53	9,80	14,50	24,00	41,20
480-8M	480	60	10,20	15,40	25,50	43,50
512-8M	512	64	11,00	16,30	27,30	46,00
520-8M	520	65	11,10	16,70	27,60	46,70
536-8M	536	67	11,40	16,90	28,00	47,50
544-8M	544	68	11,50	17,10	28,40	48,00
560-8M	560	70	11,60	17,30	29,00	48,80
576-8M	576	72	11,80	17,60	29,30	50,00
600-8M	600	75	11,90	17,90	29,70	50,60
608-8M	608	76	12,10	18,00	30,00	51,20
624-8M	624	78	12,50	18,50	31,00	52,40
632-8M	632	79	12,50	18,70	31,20	53,00
640-8M	640	80	12,60	18,80	31,30	53,80
656-8M	656	82	13,00	19,60	32,40	55,60
680-8M	680	85	13,00	19,40	32,60	55,30
720-8M	720	90	13,70	20,20	33,90	57,40
760-8M	760	95	14,10	21,10	35,40	60,30
776-8M	776	97	14,30	21,40	36,00	61,50
800-8M	800	100	14,50	21,90	36,40	62,30
840-8M	840	105	15,10	22,50	37,30	63,80
880-8M	880	110	15,40	23,00	38,20	65,00
912-8M	912	114	16,10	24,00	39,90	67,30
920-8M	920	115	16,20	24,00	40,10	68,00
960-8M	960	120	16,40	24,70	41,10	70,00
968-8M	968	121	16,70	24,80	41,40	70,40
976-8M	976	122	16,80	25,00	41,60	71,00
1000-8M	1000	125	17,20	25,50	42,40	72,20
1040-8M	1040	130	17,70	26,40	43,90	74,50
1064-8M	1064	133	17,90	26,70	44,80	75,70
1080-8M	1080	135	18,10	27,30	45,20	77,30
1120-8M	1120	140	18,70	27,80	46,60	79,60
1128-8M	1128	141	18,80	28,00	46,50	80,10
1160-8M	1160	145	19,10	28,50	47,70	81,40
1200-8M	1200	150	19,70	29,30	48,80	83,10
1216-8M	1216	152	19,90	29,80	49,00	83,40
1224-8M	1224	153	20,10	29,90	50,00	84,30
1256-8M	1256	157	20,50	30,60	51,20	86,50
1264-8M	1264	158	20,50	30,70	51,20	86,90
1280-8M	1280	160	20,70	31,00	51,60	88,20
1304-8M	1304	163	21,40	31,50	53,30	89,90
1352-8M	1352	169	21,60	32,00	53,80	90,80
1360-8M	1360	170	21,90	32,60	54,50	92,10
1424-8M	1424	178	22,40	33,50	55,90	95,40
1432-8M	1432	179	22,50	33,60	56,40	95,50
1440-8M	1440	180	22,60	33,70	56,40	95,70
1464-8M	1464	183	22,90	32,70	57,10	97,50
1512-8M	1512	189	23,40	34,90	57,80	99,30
1520-8M	1520	190	23,60	35,00	58,00	99,70
1552-8M	1552	194	23,90	35,60	59,40	101,30
1584-8M	1584	198	24,20	36,20	60,80	102,40
1600-8M	1600	200	24,60	36,60	61,40	103,40
1696-8M	1696	212	25,70	38,20	64,10	108,40
1728-8M	1728	216	26,10	38,80	65,00	110,10
1760-8M	1760	220	26,40	39,50	65,90	112,00
1800-8M	1800	225	26,80	40,30	66,80	113,70
1896-8M	1896	237	28,00	40,70	70,20	119,50

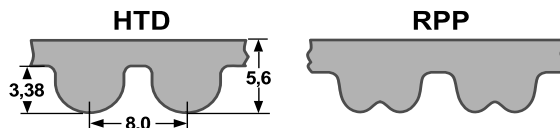

Type 8M - Teilung/ Pitch 8 mm

Größe size	Wirklänge pitch length mm	Zähnezahl number of teeth	Breite width	Breite width	Breite width	Breite width
			20 mm	30 mm	50 mm	85 mm
			Stück/ piece Euro	Stück/ piece Euro	Stück/ piece Euro	Stück/ piece Euro
1904-8M	1904	238	28,20	41,10	70,50	120,00
2000-8M	2000	250	29,70	43,10	74,10	126,00
2080-8M	2080	260	29,80	44,20	79,10	131,70
2200-8M	2200	275	31,80	47,50	80,40	136,10
2240-8M	2240	280	32,60	48,70	80,80	137,60
2272-8M	2272	284	33,00	49,00	81,70	138,90
2400-8M	2400	300	34,80	51,90	86,80	146,80
2600-8M	2600	325	37,30	55,50	92,40	157,40
2800-8M	2800	350	39,90	58,20	99,00	168,50
3048-8M	3048	381	43,30	63,40	107,60	183,40
3280-8M	3280	410	46,70	68,20	115,90	197,40
3600-8M	3600	450	51,20	75,00	127,20	216,60
4400-8M	4400	550	63,00	91,70	155,40	264,80

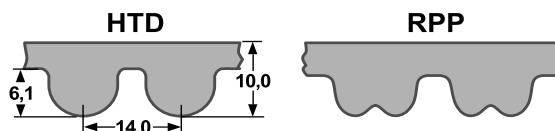

Type 14M - Teilung/ Pitch 14 mm

Größe size	Wirklänge pitch length mm	Zähnezahl number of teeth	Breite width	Breite width	Breite width	Breite width	Breite width
			40 mm	55 mm	85 mm	115 mm	170 mm
			Stück/ piece Euro	Stück/ piece Euro	Stück/ piece Euro	Stück/ piece Euro	Stück/ piece Euro
784-14M	784	56	67,50	91,00	139,80	188,80	278,50
826-14M	826	59	71,10	95,90	147,30	198,90	293,40
924-14M	924	66	79,50	107,40	164,80	222,60	328,30
966-14M	966	69	80,40	110,70	171,10	231,30	341,80
1092-14M	1092	78	84,00	115,60	179,90	243,10	357,70
1190-14M	1190	85	86,50	119,40	185,00	247,70	366,50
1260-14M	1260	90	88,80	122,90	190,40	255,70	378,10
1288-14M	1288	92	90,20	124,10	193,30	259,70	383,90
1400-14M	1400	100	93,70	130,10	201,00	271,50	401,10
1568-14M	1568	112	94,20	138,20	213,50	287,90	426,20
1610-14M	1610	115	105,00	140,50	216,50	292,20	432,20
1764-14M	1764	126	108,60	149,50	230,20	310,90	458,40
1778-14M	1778	127	109,40	151,30	233,00	314,70	464,60
1890-14M	1890	135	112,30	156,10	241,60	325,40	480,60
2100-14M	2100	150	120,60	166,30	258,40	347,90	513,90
2310-14M	2310	165	128,80	177,60	274,00	370,00	546,30
2450-14M	2450	175	133,90	185,90	286,10	387,30	571,80
2590-14M	2590	185	137,80	190,50	294,70	398,00	588,20
2800-14M	2800	200	147,40	204,00	325,90	425,30	628,40
3150-14M	3150	225	156,90	220,50	334,90	453,30	669,50
3360-14M	3360	240	170,00	230,20	353,50	478,80	706,60
3500-14M	3500	250	172,10	236,80	366,10	495,80	731,30
3850-14M	3850	275	185,90	257,20	397,10	536,40	792,60
4004-14M	4004	286	193,50	267,70	412,30	557,40	831,50
4326-14M	4326	309	205,30	283,90	438,30	591,70	896,80
4578-14M	4578	327	214,80	296,90	458,50	619,80	915,80

Type 20M auf Anfrage.

Type 20M on request.

Abmessungen in Fettdruck nur in RPP verfügbar.

Bold-faced dimensions only available in RPP.

Wickelpreise auf Anfrage.

Prices of sleeves on request.

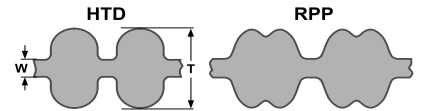

Type D 5M - Teilung/ Pitch 5 mm

Größe size	Wirklänge pitch length mm	Zähnezahl number of teeth	Breite width 9 mm	Breite width 15 mm	Breite width 25 mm
			Stück piece Euro	Stück piece Euro	Stück piece Euro
600 D 5M	600	120	37,30	55,80	82,90
610 D 5M	610	122	38,00	56,80	84,20
615 D 5M	615	123	38,30	57,20	84,90
635 D 5M	635	127	39,60	59,10	87,60
640 D 5M	640	128	40,30	59,70	89,00
670 D 5M	670	134	40,30	59,70	89,00
675 D 5M	675	135	41,70	61,90	91,80
700 D 5M	700	140	41,70	61,90	91,80
705 D 5M	705	141	41,70	61,90	91,80
710 D 5M	710	142	41,70	61,90	91,80
725 D 5M	725	145	41,70	61,90	91,80
740 D 5M	740	148	41,70	61,90	91,80
750 D 5M	750	150	42,40	64,00	94,50
755 D 5M	755	151	42,40	64,00	94,50
800 D 5M	800	160	44,50	67,50	100,00
835 D 5M	835	167	46,60	69,50	104,90
850 D 5M	850	170	46,60	69,50	104,90
890 D 5M	890	178	47,30	70,90	104,90
900 D 5M	900	180	47,30	70,90	104,90
935 D 5M	935	187	48,70	73,00	108,40
940 D 5M	940	188	49,30	73,00	108,40
950 D 5M	950	190	49,30	73,00	108,40
980 D 5M	980	196	50,10	75,70	110,50
1000 D 5M	1000	200	50,10	75,70	112,60
1025 D 5M	1025	205	52,80	77,90	116,10
1050 D 5M	1050	210	52,80	77,90	116,10
1100 D 5M	1100	220	55,00	81,40	121,70
1125 D 5M	1125	225	55,00	81,40	121,70
1135 D 5M	1135	227	55,00	81,40	121,70
1195 D 5M	1195	239	57,70	85,50	127,20
1200 D 5M	1200	240	57,70	85,50	127,90
1240 D 5M	1240	248	58,30	86,90	130,00
1270 D 5M	1270	254	59,10	87,60	131,30
1420 D 5M	1420	284	64,60	95,90	142,50
1595 D 5M	1595	319	70,20	103,50	154,40
1690 D 5M	1690	338	72,20	107,00	159,90
1790 D 5M	1790	358	76,50	113,30	168,90
1800 D 5M	1800	360	76,50	113,30	170,30
1870 D 5M	1870	374	79,90	118,80	176,50
1895 D 5M	1895	379	79,90	118,80	176,50
1945 D 5M	1945	389	83,50	124,90	184,10
2000 D 5M	2000	400	83,50	124,90	184,10
2250 D 5M	2250	450	93,90	140,50	207,10
2525 D 5M	2525	505	93,90	140,50	207,10

Preise gültig für RPP. HTD auf Anfrage.

Prices are available for RPP. HTD auf Anfrage.

Abmessungen in Fettfruck auf Anfrage.

Bold-faced dimensions on request.

Wickelpreise auf Anfrage.

Prices of sleeves on request.

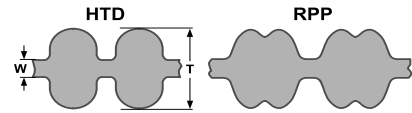

Type D 8M - Teilung/ Pitch 8 mm

Größe size	Wirklänge pitch length mm	Zähnezahl number of teeth	Breite width 20 mm	Breite width 30 mm	Breite width 50 mm	Breite width 85 mm
			Stück piece Euro	Stück piece Euro	Stück piece Euro	Stück piece Euro
600 D 8M	600	75	71,60	107,80	177,90	303,70
608 D 8M	608	76	72,20	108,40	180,00	307,20
632 D 8M	632	79	75,10	111,90	186,90	318,40
640 D 8M	640	80	75,70	112,60	187,70	322,50
680 D 8M	680	85	78,50	116,80	195,30	331,50
720 D 8M	720	90	82,00	120,90	203,70	344,00
800 D 8M	800	100	86,90	131,30	218,20	374,00
840 D 8M	840	105	90,40	134,80	223,80	382,30
880 D 8M	880	110	92,40	138,30	229,40	390,00
920 D 8M	920	115	97,30	143,90	240,50	408,00
960 D 8M	960	120	98,70	148,10	246,00	419,80
1040 D 8M	1040	130	106,30	158,50	263,40	447,00
1080 D 8M	1080	135	109,10	162,70	271,00	462,00
1120 D 8M	1120	140	111,90	166,80	279,40	477,50
1200 D 8M	1200	150	118,20	175,90	292,60	498,40
1224 D 8M	1224	153	120,20	179,30	299,60	506,00
1280 D 8M	1280	160	124,40	185,60	309,40	529,00
1352 D 8M	1352	169	130,00	192,60	322,50	545,00
1440 D 8M	1440	180	135,60	202,30	338,50	574,20
1464 D 8M	1464	183	137,90	205,70	344,10	583,80
1600 D 8M	1600	200	147,40	219,60	368,50	620,70
1760 D 8M	1760	220	158,50	237,00	395,50	672,20
1800 D 8M	1800	225	161,30	241,90	401,10	682,60
2000 D 8M	2000	250	177,90	258,50	444,20	756,30
2200 D 8M	2200	275	195,30	292,00	485,10	825,80
2400 D 8M	2400	300	208,60	311,40	520,60	880,70
2600 D 8M	2600	325	223,80	332,90	554,60	944,60
2800 D 8M	2800	350	239,10	349,70	593,60	1010,70
3048 D 8M	3048	381	259,90	380,90	645,80	1100,40
3280 D 8M	3280	410	280,10	409,40	695,10	1184,50
3600 D 8M	3600	450	307,20	449,70	763,20	1299,80
4400 D 8M	4400	550	378,10	549,90	932,80	1589,00

Preise gültig für RPP. HTD auf Anfrage.
 Prices are available for RPP. HTD auf Anfrage.

Abmessungen in Fettfruck auf Anfrage.
 Bold-faced dimensions on request.

Wickelpreise auf Anfrage.
 Prices of sleeves on request.

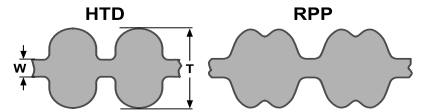

Type D 14M - Teilung/ Pitch 14 mm

Größe size	Wirklänge pitch length mm	Zähnezahl number of teeth	Breite width 40 mm	Breite width 55 mm	Breite width 85 mm	Breite width 115 mm	Breite width 170 mm
			Stück piece Euro	Stück piece Euro	Stück piece Euro	Stück piece Euro	Stück piece Euro
966 D 14M	966	69	482,40	663,80	1026,60	1387,40	2051,30
1092 D 14M	1092	78	488,40	677,10	1047,10	1440,80	2092,30
1106 D 14M	1106	79	504,60	697,40	1077,50	1457,30	2155,10
1190 D 14M	1190	85	518,60	716,00	1110,10	1486,10	2199,40
1260 D 14M	1260	90	535,10	737,40	1143,30	1530,80	2265,30
1288 D 14M	1288	92	552,00	760,20	1178,80	1578,20	2335,60
1344 D 14M	1344	96	557,20	770,20	1192,90	1603,40	2370,60
1400 D 14M	1400	100	562,40	780,60	1206,00	1628,60	2406,40
1442 D 14M	1442	103	575,30	790,60	1220,80	1648,30	2436,30
1568 D 14M	1568	112	614,00	820,60	1265,20	1707,30	2525,80
1610 D 14M	1610	115	630,50	842,50	1299,20	1753,00	2593,50
1764 D 14M	1764	126	651,00	900,60	1386,80	1873,00	2765,40
1778 D 14M	1778	127	656,20	907,80	1397,80	1887,90	2787,40
1848 D 14M	1848	132	668,20	926,90	1432,10	1931,00	2851,30
1890 D 14M	1890	135	674,20	936,40	1449,30	1952,60	2883,30
1904 D 14M	1904	136	679,90	943,30	1460,00	1967,10	2904,70
2100 D 14M	2100	150	723,60	998,20	1550,80	2087,40	3083,50
2310 D 14M	2310	165	773,00	1065,60	1643,90	2220,10	3277,40
2450 D 14M	2450	175	803,50	1114,90	1716,90	2323,70	3431,10
2590 D 14M	2590	185	827,20	1143,40	1768,30	2388,40	3529,10
2800 D 14M	2800	200	884,20	1224,10	1955,30	2551,70	3770,20
3150 D 14M	3150	225	941,10	1322,70	2009,60	2719,90	4017,00
3360 D 14M	3360	240	1003,90	1410,90	2143,40	2901,20	4284,90
3500 D 14M	3500	250	1032,30	1420,80	2196,50	2974,30	4387,50
3850 D 14M	3850	275	1114,90	1543,10	2382,80	3218,30	4755,90
4326 D 14M	4326	309	1231,70	1703,70	2629,50	3549,90	5380,80
4578 D 14M	4578	327	1288,70	1781,60	2751,20	3718,80	5494,80
4956 D 14M	4956	354	1395,10	1928,70	2978,40	4025,80	5948,50

Preise gültig für RPP. HTD auf Anfrage.
 Prices are available for RPP. HTD auf Anfrage.

Abmessungen in Fettdruck auf Anfrage.
 Bold-faced dimensions on request.

Wickelpreise auf Anfrage.
 Prices of sleeves on request.

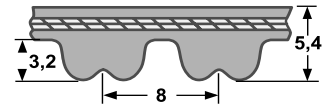

Type SLV 8 - Teilung/ Pitch 8 mm

Größe size	Wirklänge pitch length mm	Zähnezahl number of teeth	Breite width	Breite width	Breite width	Breite width
			20 mm	30 mm	50 mm	85 mm
			Stück/ piece Euro	Stück/ piece Euro	Stück/ piece Euro	Stück/ piece Euro
288 SLV 8	288	36	9,20	13,70	22,70	37,00
320 SLV 8	320	40	10,30	15,20	25,20	41,00
352 SLV 8	352	44	10,70	16,30	26,90	46,20
360 SLV 8	360	45	10,80	16,40	27,10	46,60
384 SLV 8	384	48	11,00	16,70	27,60	47,40
408 SLV 8	408	51	11,40	17,00	28,30	48,40
456 SLV 8	456	57	11,60	17,50	29,00	49,60
480 SLV 8	480	60	12,20	18,50	30,60	52,20
536 SLV 8	536	67	13,70	20,30	33,60	57,00
544 SLV 8	544	68	13,80	20,50	34,10	57,60
560 SLV 8	560	70	13,90	20,80	34,80	58,60
600 SLV 8	600	75	14,30	21,50	35,60	60,70
608 SLV 8	608	76	14,50	21,60	36,00	61,40
632 SLV 8	632	79	15,00	22,40	37,40	63,60
640 SLV 8	640	80	15,10	22,60	37,60	64,60
680 SLV 8	680	85	15,60	23,30	39,10	66,40
720 SLV 8	720	90	16,40	24,20	40,70	68,90
800 SLV 8	800	100	17,40	26,30	43,70	74,80
840 SLV 8	840	105	18,10	27,00	44,80	76,60
880 SLV 8	880	110	18,50	27,60	45,80	78,00
896 SLV 8	896	112	19,00	28,10	46,90	79,40
920 SLV 8	920	115	19,40	28,80	48,10	81,60
960 SLV 8	960	120	19,70	29,60	49,30	84,00
1000 SLV 8	1000	125	20,60	30,60	50,90	86,60
1040 SLV 8	1040	130	21,20	31,70	52,70	89,40
1080 SLV 8	1080	135	21,70	32,80	54,20	92,80
1120 SLV 8	1120	140	22,40	33,40	55,90	95,50
1200 SLV 8	1200	150	23,60	35,20	58,60	99,70
1224 SLV 8	1224	153	24,10	35,90	60,00	101,20
1280 SLV 8	1280	160	24,80	37,20	61,90	105,80
1352 SLV 8	1352	169	25,90	38,40	64,60	109,00
1440 SLV 8	1440	180	27,10	38,90	67,70	114,80
1464 SLV 8	1464	183	27,50	39,20	68,50	117,00
1600 SLV 8	1600	200	29,50	43,90	73,70	124,10
1760 SLV 8	1760	220	31,70	47,40	79,10	134,40
1800 SLV 8	1800	225	32,20	48,40	80,20	136,40
2000 SLV 8	2000	250	35,60	51,70	88,90	151,20
2200 SLV 8	2200	275	38,20	57,00	96,50	163,30
2400 SLV 8	2400	300	41,80	62,30	104,20	176,20
2520 SLV 8	2520	315	43,40	64,60	107,50	183,10
2600 SLV 8	2600	325	44,80	66,60	110,90	188,90
2800 SLV 8	2800	350	47,90	69,80	118,80	202,20
3048 SLV 8	3048	381	52,00	76,10	129,10	220,10
3280 SLV 8	3280	410	56,00	81,80	139,10	236,90
3600 SLV 8	3600	450	61,40	90,00	152,60	259,90
4400 SLV 8	4400	550	75,60	110,00	186,50	317,80
Verfügbarkeit auf Anfrage.						
Availability on request.						

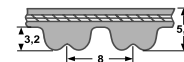

Type GLD 8 - Teilung/ Pitch 8 mm

Größe size	Wirklänge pitch length mm	Zähnezahl number of teeth	Breite width	Breite width	Breite width	Breite width
			20 mm	30 mm	50 mm	85 mm
			Stück/ piece Euro	Stück/ piece Euro	Stück/ piece Euro	Stück/ piece Euro
288 GLD 8	288	36	30,80	47,70	80,70	137,90
320 GLD 8	320	40	33,10	51,60	85,80	148,00
352 GLD 8	352	44	35,30	54,90	92,50	158,60
360 GLD 8	360	45	36,40	56,10	95,30	163,10
384 GLD 8	384	48	38,70	60,00	101,40	173,80
408 GLD 8	408	51	41,50	63,90	108,20	186,70
456 GLD 8	456	57	47,10	72,30	122,20	210,80
480 GLD 8	480	60	49,30	76,20	128,90	222,00
536 GLD 8	536	67	53,30	81,30	136,20	236,00
544 GLD 8	544	68	56,10	85,20	143,50	247,80
560 GLD 8	560	70	56,60	86,30	146,30	250,00
600 GLD 8	600	75	58,90	88,60	149,70	257,90
608 GLD 8	608	76	59,40	89,70	151,90	261,20
632 GLD 8	632	79	60,00	90,20	154,70	266,30
640 GLD 8	640	80	61,70	93,00	158,10	271,90
680 GLD 8	680	85	62,80	95,30	162,00	278,00
720 GLD 8	720	90	66,70	100,90	171,00	294,80
800 GLD 8	800	100	70,60	108,20	183,90	316,20
840 GLD 8	840	105	73,40	111,60	188,90	324,00
880 GLD 8	880	110	75,10	114,40	192,90	333,50
896 GLD 8	896	112	75,70	114,90	195,70	336,30
920 GLD 8	920	115	77,90	118,30	200,70	345,30
960 GLD 8	960	120	80,70	122,20	207,40	356,50
1000 GLD 8	1000	125	83,50	125,60	213,50	367,70
1040 GLD 8	1040	130	86,90	130,60	222,00	382,30
1080 GLD 8	1080	135	89,20	134,50	229,30	394,10
1120 GLD 8	1120	140	91,40	139,00	236,00	404,70
1200 GLD 8	1200	150	97,00	146,30	247,80	425,50
1224 GLD 8	1224	153	98,60	149,10	252,80	433,90
1280 GLD 8	1280	160	102,00	154,70	261,20	449,00
1352 GLD 8	1352	169	103,70	157,50	266,80	458,50
1440 GLD 8	1440	180	110,40	168,20	284,80	487,70
1464 GLD 8	1464	183	115,40	175,40	296,00	509,60
1600 GLD 8	1600	200	120,50	181,60	308,80	529,70
1760 GLD 8	1760	220	129,50	197,30	333,50	572,90
1800 GLD 8	1800	225	132,30	200,70	340,80	585,30
2000 GLD 8	2000	250	146,30	221,40	373,90	643,50
2200 GLD 8	2200	275	158,60	239,90	406,40	699,60
2400 GLD 8	2400	300	171,50	259,50	438,90	755,10
2520 GLD 8	2520	315	176,00	266,80	451,80	774,70
2600 GLD 8	2600	325	181,60	275,20	466,40	799,30
2800 GLD 8	2800	350	196,20	296,00	502,30	864,90
3048 GLD 8	3048	381	229,30	349,20	586,30	1005,10
3280 GLD 8	3280	410	246,60	375,00	629,50	1082,40
3600 GLD 8	3600	450	270,70	410,90	693,40	1186,10
4400 GLD 8	4400	550	330,20	502,30	848,10	1451,80
Verfügbarkeit auf Anfrage.						
Availability on request.						

ConCar

RPP Gold (Panther) - Neoprene - Zahnflachriemen mit Glasfaser - Zugträger
 RPP Gold (Panther) - Neoprene - Timing Belts with fibreglass cord

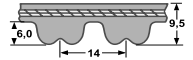

Type GLD 14 - Teilung/ Pitch 14 mm

Größe size	Wirklänge pitch length mm	Zähnezahl number of teeth	Breite width	Breite width	Breite width	Breite width	Breite width
			40 mm	55 mm	85 mm	115 mm	170 mm
			Stück/ piece Euro	Stück/ piece Euro	Stück/ piece Euro	Stück/ piece Euro	Stück/ piece Euro
966 GLD 14	966	69	382,90	538,70	881,20	1145,80	1696,80
994 GLD 14	994	71	394,10	542,10	888,00	1148,60	1701,30
1092 GLD 14	1092	78	398,50	544,90	895,20	1153,10	1709,70
1106 GLD 14	1106	79	404,10	552,10	907,00	1168,20	1731,60
1190 GLD 14	1190	85	424,40	580,70	910,40	1226,50	1819,50
1260 GLD 14	1260	90	426,60	583,50	914,20	1231,60	1826,90
1288 GLD 14	1288	92	431,10	589,70	924,40	1245,00	1847,00
1344 GLD 14	1344	96	434,40	609,90	964,70	1299,30	1927,80
1400 GLD 14	1400	100	452,40	635,10	995,00	1338,10	1985,50
1442 GLD 14	1442	103	466,10	654,20	1024,70	1378,40	2044,90
1568 GLD 14	1568	112	480,40	675,50	1050,50	1410,30	2081,60
1610 GLD 14	1610	115	493,30	693,40	1078,50	1447,90	2137,40
1764 GLD 14	1764	126	528,60	738,80	1136,80	1546,60	2285,40
1778 GLD 14	1778	127	533,60	747,20	1145,80	1557,80	2303,90
1848 GLD 14	1848	132	536,50	758,40	1159,80	1580,20	2332,40
1890 GLD 14	1890	135	548,80	775,20	1186,10	1616,10	2385,10
1904 GLD 14	1904	136	549,30	780,80	1195,10	1628,40	2403,10
1960 GLD 14	1960	140	549,90	785,90	1200,70	1676,10	2473,70
2100 GLD 14	2100	150	677,50	954,00	1478,80	1983,60	2929,30
2240 GLD 14	2240	160	702,00	982,40	1492,30	2043,40	3029,80
2310 GLD 14	2310	165	723,90	1013,40	1538,80	2107,30	3124,60
2380 GLD 14	2380	170	734,30	1023,70	1588,40	2143,40	3168,70
2450 GLD 14	2450	175	756,10	1046,90	1634,80	2206,60	3261,90
2590 GLD 14	2590	185	769,00	1075,90	1681,20	2273,00	3365,00
2660 GLD 14	2660	190	791,60	1104,90	1765,70	2304,60	3403,10
2800 GLD 14	2800	200	833,50	1162,90	1858,50	2425,80	3582,30
3150 GLD 14	3150	225	878,00	1253,80	1905,50	2585,60	3821,40
3360 GLD 14	3360	240	940,60	1336,30	2031,20	2760,40	4073,50
3500 GLD 14	3500	250	957,90	1347,90	2097,00	2820,90	4170,80
3850 GLD 14	3850	275	1052,70	1462,70	2273,00	3061,40	4518,30
3920 GLD 14	3920	280	1072,00	1467,90	2314,20	3117,10	4639,50
4326 GLD 14	4326	309	1164,20	1620,00	2494,10	3379,80	5119,70
4578 GLD 14	4578	327	1211,30	1696,70	2617,20	3539,70	5231,90
4956 GLD 14	4956	354	1297,00	1813,30	2818,40	3765,30	5649,60

RPP Gold Eigenschaften:

- Erhöhte Kraftübertragung bis ca. 300 % im Vergleich zum RPP-Standard.
- Läuft auf herkömmlichen HTD/ RPP - Scheiben.
- In 8 mm und 14 mm Teilung verfügbar.
- Längere Lebensdauer als Standardriemen.
- Kompaktere Bauweise der Antriebe möglich.
- Geringere Geräuschbildung.
- Reduzierte Vibration und somit laufruhiger.
- Wartungsfrei, keine Schmierung notwendig im Vergleich zu Kettenantrieben.

Verfügbarkeit auf Anfrage.

Availability on request.

RPP Gold features:

- Increase in load carrying capacity by up to 300 % compared to RPP standard.
- Existing systems can be upgraded without having to replace the pulleys.
- Available in a range of sizes in 8 mm and 14 mm pitch.
- Longer life than standard drives.
- More compact drives.
- Reduced noise.
- Precision ground backside to reduce vibration.
- No lubrication or maintenance compared to chain drives.

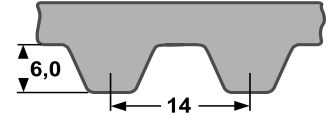

Type PC - 14MGT - Teilung/ Pitch 14 mm

Größe size	Wirklänge pitch length mm	Zähnezahl number of teeth	Breite width	Breite width	Breite width	Breite width	Breite width
			20 mm Stück piece Euro	37 mm Stück piece Euro	68 mm Stück piece Euro	90 mm Stück piece Euro	125 mm Stück piece Euro
PC-14MGT - 994	994	71	193,40	357,90	657,70	870,50	1209,00
PC-14MGT - 1120	1120	80	211,30	390,80	718,30	950,80	1320,50
PC-14MGT - 1190	1190	85	221,20	409,20	752,10	995,40	1382,50
PC-14MGT - 1260	1260	90	231,20	427,60	785,70	1040,00	1444,40
PC-14MGT - 1400	1400	100	250,90	464,20	853,20	1129,20	1568,30
PC-14MGT - 1568	1568	112	274,70	508,20	934,00	1236,20	1592,20
PC-14MGT - 1750	1750	125	300,60	555,90	1021,60	1352,10	1878,00
PC-14MGT - 1890	1890	135	313,90	595,20	1101,70	1441,90	2001,10
PC-14MGT - 1960	1960	140	330,20	610,90	1122,80	1486,00	2063,90
PC-14MGT - 2100	2100	150	350,10	647,60	1190,20	1575,10	2187,70
PC-14MGT - 2240	2240	160	369,80	684,20	1257,50	1664,30	2311,60
PC-14MGT - 2380	2380	170	389,70	720,90	1325,00	1753,60	2435,40
PC-14MGT - 2520	2520	180	409,40	757,60	1392,20	1842,80	2559,30
PC-14MGT - 2660	2660	190	429,30	794,20	1459,70	1931,90	2683,20
PC-14MGT - 2800	2800	200	449,20	830,90	1527,10	2021,10	2807,10
PC-14MGT - 3136	3136	224	496,60	919,00	1688,80	2235,20	3104,40
PC-14MGT - 3304	3304	236	520,50	962,90	1769,60	2342,10	3253,00
PC-14MGT - 3500	3500	250	548,20	1014,20	1865,90	2467,10	3426,50
PC-14MGT - 3920	3920	280	607,70	1124,20	2066,20	2734,60	3798,10
PC-14MGT - 4410	4410	310	677,10	1252,50	2302,00	3046,80	4231,70
Verfügbarkeit auf Anfrage. Availability on request.							

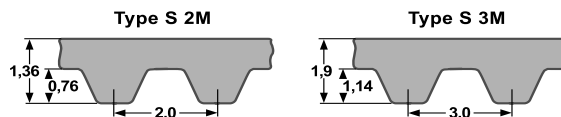

Type S 2 M - Teilung/ Pitch 2 mm		Type S 3 M - Teilung/ Pitch 3 mm	
Bezeichnung designation Wirklänge / mm pitch length / mm	Bezeichnung designation Wirklänge / mm pitch length / mm	Bezeichnung designation Wirklänge / mm pitch length / mm	Bezeichnung designation Wirklänge / mm pitch length / mm
S 2M 90 G	S 2M 334 PU-K	S 3M 120 PU-K	S 3M 459 PU-K/G
S 2M 92 G	S 2M 340 PU-K/G	S 3M 129 G	S 3M 468 G
S 2M 100 PU-K/G	S 2M 344 G	S 3M 144 PU-K/G	S 3M 480 G
S 2M 102 G	S 2M 354 PU-K	S 3M 150 PU-K/G	S 3M 486 PU-K/G
S 2M 112 PU-K	S 2M 360 PU-K	S 3M 159 PU-K	S 3M 489 G
S 2M 114 G	S 2M 364 G	S 3M 162 G	S 3M 501 PU-K/G
S 2M 116 PU-K/G	S 2M 370 PU-K/G	S 3M 168 G	S 3M 504 PU-K
S 2M 120 PU-K/G	S 2M 380 PU-K/G	S 3M 171 G	S 3M 507 PU-K
S 2M 122 PU-K/G	S 2M 386 G	S 3M 174 PU-K	S 3M 516 G
S 2M 126 PU-K/G	S 2M 396 G	S 3M 177 PU-K/G	S 3M 519 G
S 2M 128 G	S 2M 400 PU-K/G	S 3M 180 G	S 3M 525 G
S 2M 134 G	S 2M 408 G	S 3M 186 G	S 3M 537 PU-K/G
S 2M 138 PU-K	S 2M 420 G	S 3M 192 PU-K/G	S 3M 540 G
S 2M 140 PU-K/G	S 2M 436 PU-K	S 3M 195 PU-K	S 3M 549 G
S 2M 142 PU-K/G	S 2M 438 G	S 3M 201 PU-K/G	S 3M 564 PU-K/G
S 2M 144 PU-K/G	S 2M 440 PU-K	S 3M 204 PU-K	S 3M 588 PU-K/G
S 2M 148 PU-K	S 2M 448 PU-K/G	S 3M 207 G	S 3M 597 G
S 2M 150 G	S 2M 452 G	S 3M 210 PU-K/G	S 3M 600 PU-K/G
S 2M 158 PU-K/G	S 2M 454 PU-K	S 3M 213 PU-K	S 3M 609 PU-K/G
S 2M 160 PU-K/G	S 2M 460 PU-K	S 3M 219 PU-K/G	S 3M 633 PU-K/G
S 2M 164 PU-K/G	S 2M 474 G	S 3M 225 PU-K/G	S 3M 657 G
S 2M 166 PU-K/G	S 2M 480 PU-K	S 3M 228 G	S 3M 660 PU-K/G
S 2M 168 G	S 2M 488 PU-K	S 3M 234 PU-K/G	S 3M 666 PU-K
S 2M 170 PU-K/G	S 2M 490 G	S 3M 237 G	S 3M 681 PU-K/G
S 2M 172 PU-K/G	S 2M 494 PU-K	S 3M 240 PU-K	S 3M 699 PU-K/G
S 2M 176 G	S 2M 500 PU-K/G	S 3M 243 G	S 3M 735 G
S 2M 180 PU-K/G	S 2M 504 PU-K	S 3M 246 PU-K	S 3M 750 PU-K
S 2M 184 PU-K/G	S 2M 520 PU-K/G	S 3M 252 PU-K/G	S 3M 765 PU-K
S 2M 186 G	S 2M 530	S 3M 255 PU-K/G	S 3M 774 PU-K
S 2M 190 PU-K/G	S 2M 540 G	S 3M 258 G	S 3M 789 PU-K/G
S 2M 192 G	S 2M 560 PU-K/G	S 3M 264 PU-K/G	S 3M 804 PU-K
S 2M 198 G	S 2M 580 PU-K	S 3M 267 PU-K	S 3M 810 PU-K/G
S 2M 200 PU-K/G	S 2M 594 G	S 3M 270 PU-K	S 3M 852 G
S 2M 202 G	S 2M 596 G	S 3M 276 PU-K/G	S 3M 882 G
S 2M 210 G	S 2M 600 PU-K/G	S 3M 285 PU-K/G	S 3M 885 G
S 2M 214 PU-K/G	S 2M 630 PU-K/G	S 3M 288 G	S 3M 900 PU-K/G
S 2M 216 G	S 2M 656 G	S 3M 300 PU-K/G	S 3M 918 G
S 2M 220 PU-K/G	S 2M 710 PU-K/G	S 3M 303 G	S 3M 927 G
S 2M 222 G	S 2M 752 G	S 3M 309 G	S 3M 936 G
S 2M 224 PU-K/G	S 2M 754 PU-K/G	S 3M 312 PU-K/G	S 3M 990 G
S 2M 230 PU-K/G	S 2M 790 PU-K	S 3M 318 PU-K/G	S 3M 1005 PU-K
S 2M 234 PU-K/G	S 2M 796 G	S 3M 327 PU-K/G	S 3M 1050 PU-K
S 2M 236 PU-K	S 2M 800 PU-K/G	S 3M 330 G	S 3M 1146 G
S 2M 240 PU-K/G	S 2M 806 PU-K	S 3M 339 PU-K/G	S 3M 1188 G
S 2M 250 PU-K/G	S 2M 900 PU-K/G	S 3M 342 PU-K	S 3M 1260 PU-K
S 2M 258 PU-K	S 2M 940 G	S 3M 354 PU-K	S 3M 1299 G
S 2M 260 PU-K/G	S 2M 946 G	S 3M 360 PU-K/G	S 3M 1596 PU-K
S 2M 262 G	S 2M 950 G	S 3M 363 G	S 3M 1800 PU-K
S 2M 266 PU-K/G	S 2M 976 PU-K	S 3M 366 G	S 3M 2082 G
S 2M 274 G	S 2M 984 G	S 3M 372 G	S 3M 2100 PU-K
S 2M 280 PU-K/G	S 2M 1000 PU-K	S 3M 378 G	
S 2M 288 G	S 2M 1036 G	S 3M 384 PU-K/G	
S 2M 290 G	S 2M 1074 G	S 3M 387 G	
S 2M 292 G	S 2M 1110 G	S 3M 396 PU-K	
S 2M 296 PU-K/G	S 2M 1136 G	S 3M 399 G	
S 2M 300 PU-K/G	S 2M 1154 G	S 3M 402 PU-K/G	
S 2M 308 G	S 2M 1166 G	S 3M 405 PU-K/G	
S 2M 314 PU-K	S 2M 1224 G	S 3M 417 PU-K	
S 2M 316 G	S 2M 1228 G	S 3M 420 PU-K/G	
S 2M 320 PU-K/G		S 3M 423 G	
S 2M 322 G		S 3M 432 PU-K	
S 2M 324 G		S 3M 447 PU-K	
S 2M 328 G		S 3M 453 PU-K/G	
			Preise auf Anfrage. Prices on request.

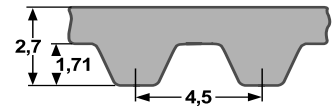

Type S 4,5 M - Teilung/ Pitch 4,5 mm

Bezeichnung type	Zähnezahl number of teeth	Breite/width		
		9 mm Code - No. 090 Stück/piece Euro	15 mm Code -No. 150 Stück/piece Euro	25 mm Code -No. 250 Stück/piece Euro
Wirklänge / mm pitch length / mm				
S 4,5 M 162	36	3,10	4,30	6,20
S 4,5 M 180	40	3,40	4,70	6,60
S 4,5 M 198	44	3,40	4,90	7,00
S 4,5 M 203	45	3,50	4,90	7,20
S 4,5 M 225	50	3,60	5,20	7,60
S 4,5 M 239	53	3,70	5,50	8,00
S 4,5 M 252	56	3,80	5,80	8,50
S 4,5 M 257	57	3,90	5,90	8,60
S 4,5 M 275	61	4,10	6,20	8,90
S 4,5 M 279	62	4,10	6,20	9,00
S 4,5 M 284	63	4,20	6,30	9,10
S 4,5 M 293	65	4,20	6,40	9,20
S 4,5 M 297	66	4,20	6,40	9,30
S 4,5 M 315	70	4,30	6,50	9,30
S 4,5 M 324	72	4,30	6,50	9,50
S 4,5 M 329	73	4,30	6,50	9,70
S 4,5 M 333	74	4,30	6,60	9,80
S 4,5 M 338	75	4,30	6,60	9,80
S 4,5 M 347	77	4,60	6,70	9,90
S 4,5 M 351	78	4,60	6,70	9,90
S 4,5 M 360	80	4,60	6,70	10,00
S 4,5 M 369	82	4,60	6,70	10,00
S 4,5 M 383	85	4,70	6,80	10,20
S 4,5 M 387	86	4,70	6,80	10,30
S 4,5 M 396	88	4,80	6,80	10,40
S 4,5 M 414	92	4,90	7,20	11,00
S 4,5 M 437	97	5,20	7,90	11,60
S 4,5 M 441	98	5,30	7,90	11,80
S 4,5 M 450	100	5,50	8,10	12,10
S 4,5 M 454	103	5,70	8,40	12,20
S 4,5 M 468	104	5,70	8,40	12,20
S 4,5 M 482	107	5,70	8,40	12,30
S 4,5 M 486	108	5,70	8,40	12,30
S 4,5 M 491	109	5,80	8,50	12,40
S 4,5 M 500	111	5,80	8,60	12,50
S 4,5 M 504	112	5,90	8,60	12,60
S 4,5 M 513	114	5,90	8,70	12,70
S 4,5 M 518	115	5,90	8,70	12,80
S 4,5 M 558	124	6,00	9,00	13,50
S 4,5 M 563	125	6,00	9,00	13,50
S 4,5 M 567	126	6,20	9,00	13,60
S 4,5 M 612	136	6,40	9,20	14,10
S 4,5 M 617	137	6,40	9,30	14,20
S 4,5 M 630	140	6,50	9,70	14,60
S 4,5 M 653	145	6,60	9,90	14,70
S 4,5 M 675	150	6,70	10,00	15,00
S 4,5 M 711	158	6,80	10,20	15,20
S 4,5 M 729	162	7,00	10,30	15,30
S 4,5 M 738	164	7,00	10,40	15,50
S 4,5 M 801	178	7,30	11,10	16,60
S 4,5 M 864	192	8,00	11,50	16,90
S 4,5 M 905	201	8,40	11,70	17,20
S 4,5 M 932	207	8,60	11,90	17,40
S 4,5 M 950	211	8,70	12,20	17,70
S 4,5 M 1031	229	9,00	12,70	18,90
S 4,5 M 1350	300	11,90	16,70	24,70
S 4,5 M 2111	469	15,90	23,70	34,90

Wickelpreise und weitere Abmessungen auf Anfrage.

Prices of sleeves and further dimensions on request.

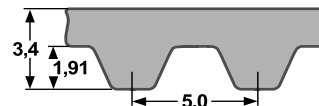

Type S 5 M - Teilung/Pitch 5 mm

Bezeichnung type	Zähnezahl number of teeth	Breite/width 9 mm Code - No. 090 Stück/piece Euro	Breite/width 15 mm Code -No. 150 Stück/piece Euro	Breite/width 25 mm Code -No. 250 Stück/piece Euro
Wirklänge / mm pitch length / mm				
S 5 M 225	45	3,90	6,00	8,60
S 5 M 255	51	4,20	6,50	9,30
S 5 M 260	52	4,60	6,60	9,90
S 5 M 275	55	4,70	6,80	10,10
S 5 M 295	59	4,70	6,80	10,30
S 5 M 300	60	4,80	7,00	10,30
S 5 M 305	61	4,80	7,10	10,40
S 5 M 320	64	4,90	7,30	10,60
S 5 M 325	65	4,90	7,30	10,60
S 5 M 350	70	5,10	7,40	10,90
S 5 M 375	75	5,10	7,50	11,20
S 5 M 390	78	5,20	7,60	11,50
S 5 M 400	80	5,30	7,70	11,60
S 5 M 410	82	5,40	7,70	11,70
S 5 M 420	84	5,50	7,90	11,80
S 5 M 425	85	5,50	7,90	11,80
S 5 M 435	87	5,90	8,50	12,60
S 5 M 450	90	6,20	8,90	13,40
S 5 M 475	95	6,40	9,20	13,60
S 5 M 490	98	6,40	9,30	13,80
S 5 M 500	100	6,50	9,50	14,00
S 5 M 520	104	6,60	9,80	14,20
S 5 M 525	105	6,60	9,80	14,20
S 5 M 550	110	6,60	9,90	14,70
S 5 M 560	112	6,60	10,00	15,00
S 5 M 565	113	6,60	10,00	15,00
S 5 M 575	115	6,70	10,10	15,10
S 5 M 590	118	6,80	10,30	15,30
S 5 M 600	120	6,80	10,40	15,50
S 5 M 625	125	7,10	10,60	15,90
S 5 M 635	127	7,20	10,60	16,10
S 5 M 645	129	7,30	10,90	16,40
S 5 M 650	130	7,30	10,90	16,40
S 5 M 665	133	7,40	11,10	16,40
S 5 M 670	134	7,40	11,10	16,40
S 5 M 675	135	7,50	11,20	16,60
S 5 M 690	138	7,50	11,20	16,70
S 5 M 695	139	7,60	11,20	16,80
S 5 M 700	140	7,60	11,20	16,80
S 5 M 710	142	7,60	11,40	16,90
S 5 M 725	145	7,60	11,50	16,90
S 5 M 730	146	7,60	11,50	16,90
S 5 M 740	148	7,70	11,60	17,10
S 5 M 750	150	7,70	11,70	17,30
S 5 M 765	153	7,90	11,90	17,60
S 5 M 770	154	8,00	12,10	17,70
S 5 M 775	155	8,00	12,10	17,70
S 5 M 780	156	8,00	12,20	17,80
S 5 M 800	160	8,30	12,40	18,40
S 5 M 810	162	8,30	12,50	18,70
S 5 M 830	166	8,40	12,50	18,80
S 5 M 845	169	8,40	12,60	18,90
S 5 M 850	170	8,50	12,60	19,00
S 5 M 860	172	8,60	12,60	19,10
S 5 M 870	174	8,60	12,80	19,20
S 5 M 900	180	8,70	12,90	19,30
S 5 M 940	188	9,00	13,20	19,70
S 5 M 950	190	9,00	13,40	19,80
S 5 M 965	193	9,10	13,50	20,10
S 5 M 975	195	9,20	13,80	20,30
S 5 M 1000	200	9,30	13,90	20,60
S 5 M 1025	205	9,50	14,10	20,90

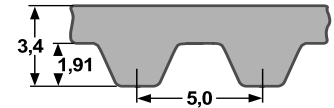

Type S 5 M - Teilung/Pitch 5 mm

Bezeichnung type	Zähnezahl number of teeth	Breite/width 9 mm Code - No. 090 Stück/piece Euro	Breite/width 15 mm Code -No. 150 Stück/piece Euro	Breite/width 25 mm Code -No. 250 Stück/piece Euro
S 5 M 1050	210	9,70	14,20	21,20
S 5 M 1055	211	9,70	14,20	21,20
S 5 M 1085	217	9,90	14,60	21,60
S 5 M 1105	221	10,00	14,90	21,90
S 5 M 1115	223	10,00	14,90	22,00
S 5 M 1120	224	10,10	15,00	22,20
S 5 M 1125	225	10,10	15,00	22,30
S 5 M 1135	227	10,20	15,10	22,50
S 5 M 1145	229	10,30	15,20	22,60
S 5 M 1160	232	10,40	15,30	22,90
S 5 M 1165	233	10,40	15,30	22,90
S 5 M 1195	239	10,50	15,60	23,20
S 5 M 1225	245	10,60	15,80	23,60
S 5 M 1250	250	10,80	15,90	23,90
S 5 M 1270	254	10,90	16,10	24,10
S 5 M 1295	259	11,10	16,40	24,60
S 5 M 1350	270	11,40	16,90	25,20
S 5 M 1420	284	11,80	17,60	26,10
S 5 M 1500	300	12,50	18,60	27,50
S 5 M 1505	301	12,50	18,70	27,70
S 5 M 1530	306	12,70	19,00	28,00
S 5 M 1595	319	13,40	19,80	29,30
S 5 M 1605	321	13,40	19,80	29,50
S 5 M 1800	360	15,00	22,40	33,00
S 5 M 2000	400	16,70	24,80	36,70
S 5 M 2145	429	17,80	26,60	39,40
S 5 M 2255	451	18,80	27,90	41,50
S 5 M 2300	460	19,10	28,50	42,30
S 5 M 2525	505	21,10	31,30	46,40

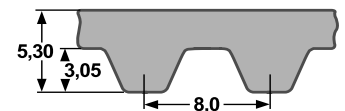

Type S 8 M - Teilung/Pitch 8 mm

Bezeichnung type	Zähnezahl number of teeth	Breite/width 20 mm Code - No. 200 Stück/piece Euro	Breite/width 30 mm Code - No. 300 Stück/piece Euro	Breite/width 50 mm Code - No. 500 Stück/piece Euro	Breite/width 85 mm Code - No. 850 Stück/piece Euro
S 8 M 376	47	9,50	14,20	23,90	40,80
S 8 M 384	48	9,80	14,60	24,30	41,80
S 8 M 400	50	10,00	15,00	24,90	42,50
S 8 M 424	53	10,30	15,40	25,60	43,60
S 8 M 440	55	10,50	15,60	26,00	44,20
S 8 M 456	57	10,60	16,00	26,50	45,10
S 8 M 480	60	10,90	16,30	27,20	46,30
S 8 M 496	62	11,20	16,90	28,00	47,50
S 8 M 512	64	11,70	17,50	29,00	48,80
S 8 M 520	65	11,80	17,70	29,30	49,20
S 8 M 560	70	12,40	18,50	30,70	51,80
S 8 M 584	73	12,60	18,80	31,20	53,00
S 8 M 600	75	12,70	19,00	31,50	54,00
S 8 M 632	79	13,40	19,80	32,90	56,50
S 8 M 640	80	13,50	19,90	33,20	57,40
S 8 M 656	82	13,90	20,90	34,40	59,10
S 8 M 672	84	14,00	21,00	34,80	59,50
S 8 M 680	85	14,10	21,10	35,00	59,70
S 8 M 712	89	14,50	21,40	36,00	60,60
S 8 M 720	90	14,50	21,50	36,10	60,80

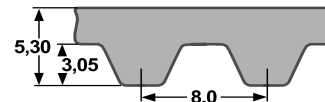

Type S 8 M - Teilung/Pitch 8 mm

Bezeichnung type	Zähnezahl number of teeth	Breite/width	Breite/width	Breite/width	Breite/width
		20 mm	30 mm	50 mm	85 mm
Wirklänge / mm pitch length / mm		Code - No. 200	Code - No. 300	Code - No. 500	Code - No. 850
		Stück/piece	Stück/piece	Stück/piece	Stück/piece
		Euro	Euro	Euro	Euro
S 8 M 728	91	14,70	21,60	36,40	61,50
S 8 M 760	95	15,20	22,40	37,70	63,90
S 8 M 800	100	15,40	23,20	38,70	66,40
S 8 M 824	103	15,80	23,70	39,30	67,20
S 8 M 840	105	16,00	23,90	39,60	67,80
S 8 M 848	106	16,10	24,00	39,90	68,70
S 8 M 880	110	16,40	24,40	40,60	69,10
S 8 M 888	111	16,60	24,70	41,10	69,60
S 8 M 896	112	16,80	24,90	41,40	70,20
S 8 M 920	115	17,30	25,60	42,60	72,00
S 8 M 944	118	17,50	26,00	43,20	73,40
S 8 M 960	120	17,60	26,20	43,60	74,60
S 8 M 976	122	17,90	26,60	44,50	75,50
S 8 M 984	123	17,90	26,60	44,60	75,60
S 8 M 1000	125	18,40	27,20	45,30	76,80
S 8 M 1032	129	18,80	27,80	46,40	78,50
S 8 M 1040	130	18,90	28,00	46,60	78,90
S 8 M 1056	132	19,10	28,50	47,50	80,70
S 8 M 1080	135	19,30	29,00	48,20	81,50
S 8 M 1096	137	19,60	29,20	48,60	81,90
S 8 M 1120	140	19,80	29,70	49,10	84,60
S 8 M 1128	141	19,90	29,80	49,30	84,80
S 8 M 1136	142	19,90	29,80	49,50	85,10
S 8 M 1152	144	20,30	30,10	50,50	85,80
S 8 M 1160	145	20,30	30,30	50,90	86,40
S 8 M 1184	148	20,70	31,00	51,50	87,60
S 8 M 1192	149	20,90	31,10	51,60	88,10
S 8 M 1200	150	21,00	31,30	51,80	88,50
S 8 M 1216	152	21,20	31,60	52,20	88,90
S 8 M 1224	153	21,30	31,80	53,00	89,80
S 8 M 1240	155	21,60	32,30	54,00	91,10
S 8 M 1248	156	21,70	32,50	54,30	91,90
S 8 M 1256	157	21,90	32,70	54,50	92,70
S 8 M 1280	160	22,20	32,90	54,80	93,60
S 8 M 1296	162	22,60	33,30	55,90	94,60
S 8 M 1304	163	22,80	33,60	56,50	95,80
S 8 M 1312	164	22,80	33,70	56,80	96,10
S 8 M 1320	165	22,90	33,80	57,00	96,40
S 8 M 1344	168	23,10	34,30	57,80	97,30
S 8 M 1352	169	23,10	34,40	58,00	97,70
S 8 M 1360	170	23,20	34,70	58,20	98,00
S 8 M 1384	173	23,40	35,00	59,10	99,30
S 8 M 1392	174	23,60	35,10	59,20	99,60
S 8 M 1400	175	23,70	35,30	59,30	100,00
S 8 M 1424	178	23,90	35,60	59,50	101,40
S 8 M 1440	180	24,00	35,80	60,00	101,80
S 8 M 1480	185	24,60	36,50	60,80	104,10
S 8 M 1520	190	25,00	37,30	61,60	106,10
S 8 M 1600	200	26,10	38,80	64,70	109,60
S 8 M 1648	206	26,60	39,10	66,60	112,50
S 8 M 1680	210	27,30	40,30	67,70	114,30
S 8 M 1696	212	27,40	40,60	68,20	115,10
S 8 M 1728	216	27,70	41,30	69,10	117,10
S 8 M 1760	220	28,10	41,90	69,80	119,10
S 8 M 1776	222	28,20	42,30	70,20	120,10
S 8 M 1800	225	28,60	42,90	70,80	121,30
S 8 M 1816	227	28,90	43,10	71,40	122,30
S 8 M 1832	229	29,10	43,50	72,00	123,10
S 8 M 1880	235	29,50	43,80	73,30	125,60
S 8 M 1912	239	30,10	52,40	74,60	127,60
S 8 M 2000	250	31,50	45,70	78,50	134,20
S 8 M 2048	256	32,30	46,80	80,10	136,50
S 8 M 2120	265	33,00	47,70	82,10	140,10

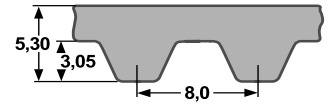

Type S 8 M - Teilung/Pitch 8 mm

Bezeichnung type	Zähnezahl number of teeth	Breite/width 20 mm Code - No. 200 Stück/piece Euro	Breite/width 30 mm Code - No. 300 Stück/piece Euro	Breite/width 50 mm Code - No. 500 Stück/piece Euro	Breite/width 85 mm Code - No. 850 Stück/piece Euro
Wirklänge / mm pitch length / mm					
S 8 M 2160	270	33,70	49,90	83,40	142,20
S 8 M 2240	280	34,70	51,80	85,80	146,30
S 8 M 2272	284	35,10	52,20	86,80	147,60
S 8 M 2304	288	36,10	52,90	88,20	149,60
S 8 M 2400	300	36,90	55,30	92,30	155,70
S 8 M 2496	312	38,30	57,10	95,40	161,40
S 8 M 2560	320	39,50	58,30	97,40	165,10
S 8 M 2600	325	39,80	59,10	98,30	167,40
S 8 M 2800	350	42,40	61,60	105,30	179,50
S 8 M 2880	360	43,60	63,40	108,30	184,70
S 8 M 3200	400	48,70	70,50	120,80	205,50
S 8 M 3272	409	49,70	72,10	123,50	210,20
S 8 M 3680	460	55,90	81,20	138,90	236,40
S 8 M 3720	465	56,50	82,10	140,50	239,00
S 8 M 4400	550	66,80	97,10	165,40	282,60

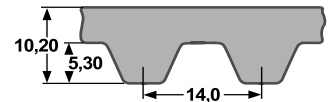

Type S 14 M - Teilung/Pitch 14 mm

Bezeichnung type	Zähnezahl number of teeth	Breite/width 40 mm Code No. 400 Stück/piece Euro	Breite/width 55 mm Code No. 550 Stück/piece Euro	Breite/width 85 mm Code No. 850 Stück/piece Euro	Breite/width 115 mm Code No. 1150 Stück/piece Euro	Breite/width 170 mm Code No. 1700 Stück/piece Euro
Wirklänge / mm pitch length / mm						
S 14 M 1008	72	73,10	100,80	155,30	209,80	309,80
S 14 M 1120	80	80,80	111,60	172,60	233,20	344,50
S 14 M 1190	85	86,00	118,90	183,40	247,90	366,00
S 14 M 1246	89	90,00	124,70	192,10	259,60	383,30
S 14 M 1400	100	101,20	139,70	215,90	291,60	430,50
S 14 M 1540	110	105,60	145,30	223,70	302,80	446,50
S 14 M 1610	115	108,50	150,60	231,90	314,00	463,70
S 14 M 1652	118	110,80	152,30	235,00	318,10	468,90
S 14 M 1750	125	112,50	154,90	239,70	323,60	478,50
S 14 M 1778	127	114,70	157,40	243,60	329,20	485,90
S 14 M 1806	129	116,40	160,10	247,00	334,50	493,20
S 14 M 1890	135	121,60	167,40	258,60	349,60	516,60
S 14 M 1904	136	122,40	168,70	260,90	352,20	520,50
S 14 M 1932	138	123,30	170,40	264,00	356,00	525,60
S 14 M 2002	143	124,70	173,60	268,20	362,20	533,80
S 14 M 2100	150	129,40	179,10	276,90	373,40	551,20
S 14 M 2240	160	133,20	184,30	285,10	385,40	568,40
S 14 M 2310	165	137,60	190,90	293,80	397,10	587,10
S 14 M 2380	170	141,00	194,80	300,70	406,30	600,20
S 14 M 2450	175	144,50	198,60	307,10	414,80	613,10
S 14 M 2506	179	145,90	201,30	311,10	420,10	620,80
S 14 M 2590	185	147,50	204,20	316,30	427,00	631,70
S 14 M 2660	190	151,00	209,00	327,90	437,00	646,00
S 14 M 2800	200	157,90	219,00	350,90	456,40	674,50
S 14 M 3150	225	169,10	236,70	359,40	487,20	718,70
S 14 M 3500	250	183,90	254,00	392,90	530,90	785,30
S 14 M 3556	254	186,50	257,90	399,30	539,50	797,80
S 14 M 3850	275	199,90	276,50	426,10	576,30	850,10
S 14 M 4004	286	207,70	286,90	443,00	598,90	884,80
S 14 M 4326	309	224,50	309,40	478,10	646,80	954,40
S 14 M 4508	322	234,00	323,30	499,40	674,50	996,00
S 14 M 5012	358	259,60	359,40	555,10	750,30	1107,20

STS / STD - Neoprene - Zahnflachriemen - doppelt gezahnt STS / STD - Neoprene - Timing Belts - double toothed

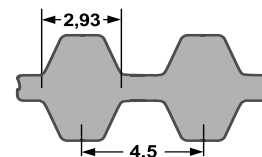

Type DS 4,5 M - Teilung/Pitch 4,5 mm

Bezeichnung type	Zähnezahl number of teeth	Breite/width 9 mm Code No. 090 Stück/piece Euro	Breite/width 15 mm Code No. 150 Stück/piece Euro	Breite/width 25 mm Code No. 250 Stück/piece Euro
Wirklänge / mm pitch length / mm				
DS 4,5 M 450	100	21,70	31,40	46,70
DS 4,5 M 491	109	22,50	33,00	48,40
DS 4,5 M 504	112	22,80	33,60	49,10
DS 4,5 M 518	115	23,00	34,10	50,20
DS 4,5 M 558	124	23,40	35,10	52,50
DS 4,5 M 563	125	23,80	35,30	52,70
DS 4,5 M 630	140	25,40	37,60	56,70
DS 4,5 M 711	158	26,60	39,90	59,20
DS 4,5 M 729	162	26,90	40,30	59,60
DS 4,5 M 801	178	28,60	43,60	64,40
DS 4,5 M 1031	229	35,40	49,50	73,50
DS 4,5 M 2110	469	61,70	92,00	136,10

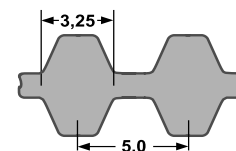

Type DS 5 M - Teilung/Pitch 5 mm

Bezeichnung type	Zähnezahl number of teeth	9 mm Code No. 090 Stück/piece Euro	15 mm Code No. 150 Stück/piece Euro	25 mm Code No. 250 Stück/piece Euro
Wirklänge / mm pitch length / mm				
DS 5 M 400	80	20,70	30,00	45,40
DS 5 M 425	85	21,40	30,40	46,10
DS 5 M 435	87	22,90	32,90	49,40
DS 5 M 450	90	24,10	34,80	51,90
DS 5 M 475	95	24,80	36,20	52,80
DS 5 M 490	98	25,00	36,70	53,90
DS 5 M 500	100	25,10	37,00	54,50
DS 5 M 520	104	25,60	37,80	55,70
DS 5 M 525	105	25,60	37,80	55,70
DS 5 M 550	110	25,90	38,50	57,60
DS 5 M 560	112	26,00	38,90	58,10
DS 5 M 575	115	26,20	39,30	58,80
DS 5 M 590	118	26,50	40,00	59,50
DS 5 M 600	120	26,80	40,60	60,40
DS 5 M 625	125	27,70	41,40	61,70
DS 5 M 650	130	28,60	42,60	64,10
DS 5 M 665	133	29,10	43,60	64,30
DS 5 M 670	134	29,10	43,60	64,30
DS 5 M 675	135	29,20	43,70	64,60
DS 5 M 690	138	29,30	43,90	65,10
DS 5 M 695	139	29,50	44,00	65,50
DS 5 M 700	140	29,50	44,00	65,50
DS 5 M 710	142	29,70	44,20	65,80
DS 5 M 725	145	29,90	44,80	66,20
DS 5 M 730	146	29,90	44,80	66,20
DS 5 M 740	148	30,00	45,20	66,50
DS 5 M 750	150	30,20	45,70	67,20
DS 5 M 765	153	31,10	46,70	68,50
DS 5 M 780	155	31,30	47,40	69,80
DS 5 M 800	160	31,80	48,40	71,60
DS 5 M 830	166	32,50	48,90	73,20
DS 5 M 845	169	32,70	49,10	73,80
DS 5 M 850	170	32,90	49,20	74,10
DS 5 M 900	180	33,70	50,70	75,60
DS 5 M 950	190	35,40	51,90	77,30
DS 5 M 975	195	36,20	53,70	78,80
DS 5 M 1000	200	36,60	54,30	80,20

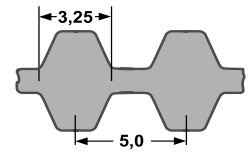

Type DS 5 M - Teilung/Pitch 5 mm

Bezeichnung type	Zähnezahl number of teeth	Breite/width 9 mm Code No. 090 Stück/piece Euro	Breite/width 15 mm Code No. 150 Stück/piece Euro	Breite/width 25 mm Code No. 250 Stück/piece Euro
Wirklänge / mm pitch length / mm				
DS 5 M 1025	205	37,00	55,10	81,50
DS 5 M 1050	210	37,70	55,70	82,90
DS 5 M 1055	211	37,70	55,70	82,90
DS 5 M 1085	217	38,30	57,10	84,30
DS 5 M 1105	221	38,70	57,70	85,30
DS 5 M 1115	223	38,90	57,90	86,00
DS 5 M 1120	224	39,10	58,10	86,60
DS 5 M 1125	225	39,30	58,30	86,90
DS 5 M 1135	227	39,90	58,80	87,30
DS 5 M 1145	229	40,30	59,20	88,10
DS 5 M 1160	232	40,60	59,70	89,20
DS 5 M 1165	233	40,60	59,70	89,20
DS 5 M 1195	239	41,20	60,90	90,90
DS 5 M 1225	245	41,70	61,40	91,80
DS 5 M 1270	254	42,40	62,60	94,00
DS 5 M 1295	259	43,20	64,00	95,80
DS 5 M 1350	270	44,60	66,20	98,50
DS 5 M 1420	284	46,10	68,70	101,70
DS 5 M 1500	300	48,80	72,10	107,20
DS 5 M 1505	301	48,90	72,80	107,90
DS 5 M 1530	306	49,90	73,90	109,50
DS 5 M 1595	319	51,80	77,10	114,30
DS 5 M 1605	321	52,10	77,30	115,00
DS 5 M 1800	360	58,30	87,10	128,90
DS 5 M 2000	400	65,00	96,60	143,20
DS 5 M 2145	429	69,70	103,80	153,70
DS 5 M 2255	451	73,20	109,10	161,60
DS 5 M 2525	505	82,00	122,10	180,90

Wickelpreise und weitere Abmessungen auf Anfrage.

Prices of sleeves and further dimensions on request.

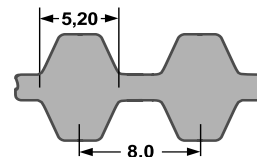

Type DS 8 M - Teilung/Pitch 8 mm

Bezeichnung type	Zähnezahl number of teeth	Breite/width 20 mm Code No. 200 Stück/piece Euro	Breite/width 30 mm Code No. 300 Stück/piece Euro	Breite/width 50 mm Code No. 500 Stück/piece Euro	Breite/width 85 mm Code No. 850 Stück/piece Euro
Wirklänge / mm pitch length / mm					
DS 8 M 480	60	46,70	70,20	116,70	198,60
DS 8 M 496	62	48,40	72,80	120,70	204,10
DS 8 M 512	64	50,20	75,10	124,50	209,80
DS 8 M 520	65	50,60	76,10	125,80	211,90
DS 8 M 560	70	53,20	79,20	132,10	222,80
DS 8 M 584	73	54,10	80,80	134,20	228,10
DS 8 M 600	75	55,00	81,80	135,70	232,00
DS 8 M 632	79	57,00	85,10	141,80	243,50
DS 8 M 640	80	57,70	85,80	143,20	246,90
DS 8 M 656	82	59,70	89,50	147,80	254,30
DS 8 M 672	84	60,40	90,30	149,70	256,30
DS 8 M 680	85	60,70	90,60	150,80	257,30
DS 8 M 712	89	62,10	92,00	154,50	260,80
DS 8 M 720	90	62,50	92,40	155,20	261,70
DS 8 M 728	91	63,10	93,40	156,60	221,20
DS 8 M 760	95	65,50	96,40	161,90	274,70
DS 8 M 800	100	66,50	100,00	166,30	285,80
DS 8 M 824	103	67,90	101,60	168,90	289,30
DS 8 M 840	105	68,40	102,80	170,50	291,30
DS 8 M 848	106	69,10	103,30	171,40	295,80
DS 8 M 880	110	70,50	105,50	174,70	296,90
DS 8 M 888	111	71,40	106,30	176,30	299,50
DS 8 M 896	112	72,10	107,30	178,00	302,30
DS 8 M 920	115	74,30	110,00	183,30	309,90
DS 8 M 944	118	75,10	111,60	185,70	316,30
DS 8 M 960	120	75,60	112,50	187,50	321,10
DS 8 M 976	122	77,00	114,60	191,20	324,80
DS 8 M 984	123	77,20	114,70	191,70	325,70
DS 8 M 1000	125	78,40	116,70	195,00	330,40
DS 8 M 1032	129	80,60	119,80	199,20	337,80
DS 8 M 1040	130	81,20	120,70	200,40	339,70
DS 8 M 1056	132	82,10	122,40	204,10	347,10
DS 8 M 1080	135	83,10	124,30	206,90	349,70
DS 8 M 1096	137	84,20	125,60	208,90	352,30
DS 8 M 1120	140	85,40	127,40	211,50	363,80
DS 8 M 1128	141	85,60	127,70	212,40	364,70
DS 8 M 1136	142	85,80	128,30	213,10	365,60
DS 8 M 1152	144	86,90	129,70	217,00	369,30
DS 8 M 1160	145	87,30	130,60	219,00	371,20
DS 8 M 1184	148	89,10	132,70	221,40	376,70
DS 8 M 1192	149	89,80	133,40	221,80	378,60
DS 8 M 1200	150	90,30	134,30	222,80	380,50
DS 8 M 1216	152	91,10	136,00	224,60	382,30
DS 8 M 1224	153	91,70	136,90	228,30	386,10
DS 8 M 1240	155	93,10	138,70	232,00	392,30
DS 8 M 1248	156	93,90	139,70	233,90	395,40
DS 8 M 1256	157	94,20	140,10	234,40	397,20
DS 8 M 1280	160	95,00	141,50	235,70	402,70
DS 8 M 1296	162	97,10	143,40	240,60	407,30
DS 8 M 1304	163	98,00	144,50	243,20	412,10
DS 8 M 1312	164	98,30	145,00	244,10	413,30
DS 8 M 1320	165	98,80	146,20	246,20	415,70
DS 8 M 1344	168	99,50	147,50	248,60	418,60
DS 8 M 1352	169	99,80	148,20	249,50	420,00
DS 8 M 1360	170	100,30	148,80	250,60	421,40
DS 8 M 1384	173	100,60	150,50	254,10	426,90
DS 8 M 1392	174	101,20	151,20	254,70	428,70
DS 8 M 1400	175	101,60	151,90	255,50	430,60
DS 8 M 1424	178	102,40	153,40	256,10	436,10
DS 8 M 1440	180	103,10	154,00	258,00	438,00
DS 8 M 1480	185	105,60	157,30	261,70	447,30
DS 8 M 1520	190	107,60	160,40	265,40	456,60

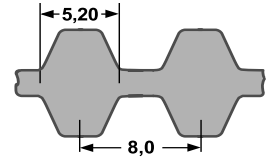

Type DS 8 M - Teilung/Pitch 8 mm

Bezeichnung type	Zähnezahl number of teeth	Breite/width 20 mm Code No. 200 Stück/piece Euro	Breite/width 30 mm Code No. 300 Stück/piece Euro	Breite/width 50 mm Code No. 500 Stück/piece Euro	Breite/width 85 mm Code No. 850 Stück/piece Euro
Wirklänge / mm pitch length / mm					
DS 8 M 1600	200	112,20	167,30	278,70	471,50
DS 8 M 1648	206	114,70	168,60	286,50	484,10
DS 8 M 1680	210	116,90	173,70	290,90	491,50
DS 8 M 1696	212	117,50	174,90	293,20	495,40
DS 8 M 1728	216	119,40	177,70	296,90	503,90
DS 8 M 1760	220	120,90	180,50	300,70	512,30
DS 8 M 1776	222	121,90	182,20	302,30	517,10
DS 8 M 1800	225	123,10	184,40	304,50	521,50
DS 8 M 1816	227	124,10	185,20	307,40	526,20
DS 8 M 1832	229	125,10	186,40	310,70	531,60
DS 8 M 1880	235	127,20	188,10	315,50	540,10
DS 8 M 1912	239	129,90	190,60	321,70	550,10
DS 8 M 2000	250	135,60	196,70	337,80	577,10
DS 8 M 2048	256	138,90	200,60	343,00	583,60
DS 8 M 2120	265	142,30	205,40	353,50	603,10
DS 8 M 2160	270	145,00	214,00	358,70	611,70
DS 8 M 2240	280	149,20	222,80	369,30	629,20
DS 8 M 2272	284	151,10	224,60	373,00	634,70
DS 8 M 2304	288	154,80	227,80	379,10	643,50
DS 8 M 2400	300	159,30	237,60	397,20	670,10
DS 8 M 2496	312	164,70	245,70	410,40	694,10
DS 8 M 2560	320	170,00	251,00	419,20	710,40
DS 8 M 2600	325	170,80	254,30	423,20	720,10
DS 8 M 2800	350	182,50	265,40	452,90	772,10
DS 8 M 2880	360	187,70	273,00	465,80	794,20
DS 8 M 3200	400	209,20	303,70	519,70	884,20
DS 8 M 3272	409	214,00	310,60	531,40	904,20
DS 8 M 3680	460	240,80	349,20	597,10	1017,20
DS 8 M 3720	465	243,40	353,10	603,50	1027,90
DS 8 M 4400	550	287,60	417,70	711,70	1215,70
Wickelpreise und weitere Abmessungen auf Anfrage.					
Prices of sleeves and further dimensions on request.					

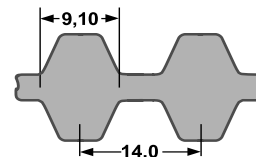

STS / STD - Neoprene - Zahnflachriemen - doppelt gezahnt
STS / STD - Neoprene - Timing Belts - double toothed

Type DS 14 M - Teilung/Pitch 14 mm

Bezeichnung type Wirklänge / mm pitch length / mm	Zähnezahl number of teeth	Breite/width 40 mm Code No. 400 Stück/Piece Euro	Breite/width 55 mm Code No. 550 Stück/Piece Euro	Breite/width 85 mm Code No. 850 Stück/Piece Euro	Breite/width 115 mm Code No. 1150 Stück/Piece Euro	Breite/width 170 mm Code No. 1700 Stück/Piece Euro
DS 14 M 1008	72	284,30	392,50	606,10	818,90	1208,70
DS 14 M 1120	80	315,90	436,00	673,60	909,90	1342,90
DS 14 M 1190	85	335,70	463,40	715,60	966,90	1426,80
DS 14 M 1246	89	351,40	485,00	749,30	1012,30	1494,00
DS 14 M 1400	100	394,90	545,00	842,00	1137,30	1678,90
DS 14 M 1540	110	411,70	566,90	872,40	1181,10	1741,40
DS 14 M 1610	115	423,50	587,10	904,30	1225,00	1808,70
DS 14 M 1652	118	429,60	593,10	914,60	1237,40	1827,60
DS 14 M 1750	125	439,10	604,80	934,40	1262,50	1865,40
DS 14 M 1778	127	446,10	614,40	949,50	1282,40	1895,10
DS 14 M 1806	129	453,20	624,00	964,40	1302,60	1924,90
DS 14 M 1890	135	474,20	653,00	1008,90	1363,40	2014,60
DS 14 M 1904	136	477,60	657,80	1016,40	1373,40	2029,60
DS 14 M 1932	138	481,10	664,00	1026,30	1386,40	2047,10
DS 14 M 2002	143	485,90	676,50	1046,20	1412,20	2082,20
DS 14 M 2100	150	504,60	698,60	1079,90	1456,10	2149,60
DS 14 M 2240	160	519,70	718,80	1111,90	1503,40	2217,20
DS 14 M 2310	165	536,50	744,10	1145,70	1548,90	2289,60
DS 14 M 2380	170	550,40	759,30	1171,90	1583,40	2340,20
DS 14 M 2450	175	563,70	774,50	1198,00	1618,10	2391,00
DS 14 M 2506	179	567,60	783,20	1210,10	1637,50	2410,40
DS 14 M 2590	185	575,40	796,30	1233,50	1665,40	2463,40
DS 14 M 2660	190	589,20	815,90	1278,40	1703,70	2519,30
DS 14 M 2800	200	615,90	853,70	1368,50	1780,20	2630,50
DS 14 M 3150	225	659,80	923,00	1402,10	1899,90	2802,70
DS 14 M 3500	250	717,10	990,50	1532,00	2065,30	3062,50
DS 14 M 3556	254	728,60	1006,30	1556,70	2098,20	3111,50
DS 14 M 3850	275	779,50	1078,20	1662,00	2247,50	3315,50
DS 14 M 4004	286	809,90	1118,60	1727,80	2335,10	3450,50
DS 14 M 4060	290	821,20	1134,30	1752,30	2367,80	3498,70
DS 14 M 4326	309	874,90	1208,80	1866,80	2522,70	3727,60
DS 14 M 4508	322	912,80	1260,50	1947,20	2630,50	3884,10
DS 14 M 5012	358	1012,40	1402,10	2164,80	2925,80	4317,80
Wickelpreise und weitere Abmessungen auf Anfrage.						
Prices of sleeves and further dimensions on request.						

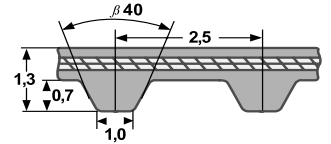

Type T 2,5 - Teilung/ Pitch 2,5 mm

Länge length	Breite width	Breite width	Breite width	Breite width	Breite width
	4mm	6mm	8mm	10mm	12mm
	Stück/ piece Euro	Stück/ piece Euro	Stück/ piece Euro	Stück/ piece Euro	Stück/ piece Euro
T2,5 120	5,90	6,50	7,50	8,40	10,00
T2,5 145	5,90	6,50	7,50	8,40	10,00
T2,5 160	5,90	6,50	7,50	8,40	10,00
T2,5 177,5	5,90	6,60	7,50	8,50	10,20
T2,5 200	6,30	6,70	7,60	8,70	10,40
T2,5 230	6,30	6,80	7,90	8,80	10,50
T2,5 245	6,30	6,80	8,00	8,90	10,60
T2,5 265	6,50	7,10	8,10	9,00	10,90
T2,5 285	6,60	7,20	8,30	9,20	11,10
T2,5 305	6,60	7,30	8,50	9,30	11,40
T2,5 317,5	6,80	7,50	8,80	9,90	11,70
T2,5 330	7,10	7,60	9,00	10,00	11,90
T2,5 380	7,20	8,00	9,00	10,10	12,20
T2,5 420	7,40	8,10	9,20	10,50	12,60
T2,5 480	7,90	8,50	9,90	11,10	13,20
T2,5 492,5	8,40	9,10	10,50	11,70	14,00
T2,5 500	8,40	9,10	10,50	11,70	14,00
T2,5 600	9,10	10,10	11,50	12,90	15,50
T2,5 620	9,70	10,50	12,10	13,60	16,10
T2,5 650	9,70	10,50	12,10	13,60	16,10
T2,5 780	9,70	11,40	12,90	14,60	17,50
T2,5 915	11,10	12,20	13,90	15,60	18,80
T2,5 950	11,10	12,30	14,10	15,80	19,00

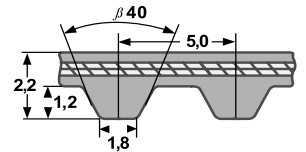

Type T 5 - Teilung/ Pitch 5 mm

Länge length	Breite width	Breite width	Breite width	Breite width	Breite width	Breite width	Breite width	Breite width
	6mm	8mm	10mm	12mm	16 mm	20 mm	25 mm	32 mm
	Stück/ piece Euro	Stück/ piece Euro	Stück/ piece Euro	Stück/ piece Euro	Stück/ piece Euro	Stück/ piece Euro	Stück/ piece Euro	Stück/ piece Euro
T5 165	5,20	6,50	7,60	8,80	10,90	12,70	14,60	19,10
T5 185	5,30	6,60	7,90	8,90	11,10	13,00	15,30	19,60
T5 200	5,30	6,60	7,90	8,90	11,10	13,00	15,30	19,60
T5 215	5,40	6,80	8,10	9,10	11,50	13,50	15,60	19,90
T5 220	5,40	6,80	8,10	9,10	11,50	13,50	15,60	19,90
T5 225	5,40	6,80	8,10	9,10	11,50	13,50	15,60	19,90
T5 245	5,40	7,00	8,30	9,10	11,70	13,70	16,00	20,50
T5 250	5,50	7,10	8,40	9,20	12,00	13,80	16,20	20,70
T5 255	5,50	7,20	8,40	9,50	12,10	14,00	16,40	21,00
T5 260	5,50	7,20	8,40	9,50	12,10	14,00	16,40	21,00
T5 270	5,80	7,30	8,70	9,80	12,20	14,30	16,70	21,40
T5 275	5,80	7,40	8,80	9,90	12,40	14,50	16,90	21,60
T5 280	5,90	7,40	8,90	10,00	12,50	14,60	17,20	21,90
T5 295	6,00	7,50	9,00	10,10	12,70	14,60	17,40	22,40
T5 300	6,20	7,60	9,10	10,30	13,10	15,20	17,70	22,70
T5 305	6,20	7,70	9,10	10,30	13,10	15,30	17,80	22,70
T5 325	6,30	7,90	9,20	10,50	13,20	15,40	18,00	23,10
T5 330	6,30	7,90	9,20	10,60	13,20	15,50	18,00	23,10
T5 340	6,30	7,90	9,20	10,60	13,20	15,50	18,00	23,10
T5 350	6,50	8,10	9,50	10,80	13,60	15,80	18,60	23,80
T5 355	6,50	8,10	9,50	10,80	13,60	15,80	18,60	23,80
T5 360	6,50	8,10	9,50	10,80	13,60	15,80	18,60	23,80
T5 365	6,50	8,10	9,50	10,80	13,60	15,80	18,60	23,80
T5 375	6,50	8,10	9,80	11,00	13,90	16,20	18,90	24,10
T5 390	6,50	8,10	9,80	11,00	13,90	16,20	18,90	24,10
T5 400	6,50	8,10	9,80	11,00	13,90	16,20	18,90	24,10

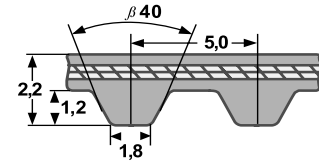

Type T 5 - Teilung/ Pitch 5 mm

Länge length	Breite width	Breite width	Breite width	Breite width	Breite width	Breite width	Breite width	Breite width
	6mm	8mm	10mm	12mm	16 mm	20 mm	25 mm	32 mm
	Stück/ piece Euro	Stück/ piece Euro	Stück/ piece Euro	Stück/ piece Euro	Stück/ piece Euro	Stück/ piece Euro	Stück/ piece Euro	Stück/ piece Euro
T5 410	6,60	8,40	10,00	11,40	14,10	16,40	19,20	24,70
T5 420	6,70	8,50	10,10	11,50	14,30	16,80	19,60	25,10
T5 425	6,70	8,50	10,10	11,50	14,30	16,80	19,60	25,10
T5 440	6,70	8,50	10,10	11,50	14,30	16,80	19,60	25,10
T5 445	6,70	8,50	10,10	11,50	14,30	16,80	19,60	25,10
T5 450	6,70	8,50	10,10	11,50	14,30	16,80	19,60	25,10
T5 455	6,70	8,50	10,10	11,50	14,30	16,80	19,60	25,10
T5 460	6,80	8,80	10,20	11,70	14,60	17,20	20,10	25,60
T5 465	6,80	8,80	10,20	11,70	14,60	17,20	20,10	25,60
T5 475	6,80	8,80	10,20	11,70	14,60	17,20	20,10	25,60
T5 480	7,10	8,90	10,40	11,90	14,90	17,40	20,30	26,00
T5 500	7,30	9,10	10,90	12,30	15,40	18,00	21,10	26,90
T5 510	7,40	9,50	11,10	12,70	16,00	18,70	21,70	28,00
T5 525	7,60	9,90	11,40	12,90	16,30	19,00	22,20	28,40
T5 545	7,90	10,00	11,80	13,50	16,80	19,60	22,90	29,30
T5 550	7,90	10,00	11,80	13,50	16,80	19,60	22,90	29,30
T5 560	7,90	10,00	11,80	13,50	16,80	19,60	22,90	29,30
T5 575	8,00	10,10	12,10	13,60	17,10	19,90	23,20	29,80
T5 590	8,10	10,20	12,20	13,70	17,30	20,10	23,60	30,00
T5 600	8,10	10,30	12,20	13,80	17,40	20,30	23,80	30,30
T5 610	8,30	10,40	12,30	14,00	17,50	20,50	23,90	30,60
T5 620	8,50	10,80	12,70	14,30	18,00	21,10	24,70	31,50
T5 625	8,50	10,80	12,70	14,30	18,00	21,10	24,70	31,50
T5 630	8,50	10,80	12,70	14,30	18,00	21,10	24,70	31,50
T5 640	8,70	10,90	12,80	14,60	18,50	21,40	25,10	32,00
T5 650	8,70	10,90	12,90	14,60	18,50	21,40	25,10	32,00
T5 660	8,80	11,10	13,00	14,90	18,70	21,70	25,40	32,60
T5 675	8,90	11,10	13,20	15,00	18,80	21,90	25,40	32,80
T5 690	8,90	11,10	13,20	15,10	18,90	22,00	25,90	33,00
T5 695	9,00	11,40	13,50	15,20	19,10	22,40	26,10	33,30
T5 700	9,00	11,40	13,50	15,20	19,10	22,40	26,10	33,30
T5 720	9,00	11,40	13,60	15,30	19,20	22,40	26,10	33,30
T5 725	9,00	11,40	13,60	15,40	19,20	22,50	26,10	33,70
T5 750	9,00	11,40	13,60	15,40	19,20	22,50	26,30	33,70
T5 780	9,10	11,50	13,70	15,40	19,40	22,70	26,50	33,90
T5 800	9,10	11,70	13,80	15,60	19,70	23,00	26,60	34,10
T5 815	9,20	11,80	14,00	15,80	19,90	23,20	27,40	35,00
T5 840	9,50	12,10	14,10	16,00	20,20	23,70	27,60	35,30
T5 850	9,70	12,10	14,20	16,20	20,30	23,70	27,60	35,40
T5 860	9,80	12,20	14,30	16,30	20,50	23,90	28,00	35,60
T5 885	9,80	12,20	14,30	16,30	20,50	23,90	28,00	35,60
T5 900	9,80	12,20	14,30	16,30	20,50	23,90	28,00	35,60
T5 940	10,00	12,50	14,90	16,80	21,20	24,80	28,90	36,90
T5 975	10,10	12,70	15,10	17,20	21,50	25,10	29,30	37,90
T5 990	10,20	12,90	15,30	17,40	21,70	25,50	29,80	38,10
T5 1000	10,30	13,20	15,50	17,70	22,20	26,00	30,10	38,70
T5 1075	11,50	14,50	17,30	19,60	24,40	28,60	33,30	42,80
T5 1100	11,70	14,90	17,60	19,90	25,00	29,20	34,20	43,70
T5 1115	11,90	15,10	17,90	20,20	25,20	29,50	34,50	44,20
T5 1140	12,20	15,40	18,10	20,60	25,90	30,10	35,30	45,30
T5 1160	12,40	15,60	18,60	21,00	26,40	30,80	36,20	46,10
T5 1215	12,80	16,30	19,20	21,90	27,40	32,00	37,40	48,00
T5 1280	14,00	17,60	20,90	23,80	29,80	34,80	40,40	52,00
T5 1315	14,50	18,40	21,60	24,60	31,00	36,20	41,90	54,10
T5 1355	14,70	18,60	22,00	24,90	31,40	36,60	42,90	55,00
T5 1380	14,90	18,80	22,30	25,10	31,60	36,90	43,20	55,40
T5 1440	15,50	19,70	23,20	26,40	33,20	38,80	45,40	58,00
T5 1955	21,10	26,70	31,60	36,00	45,10	52,70	61,60	78,90
Wickelpreise auf Anfrage.								
Prices of sleeves on request.								

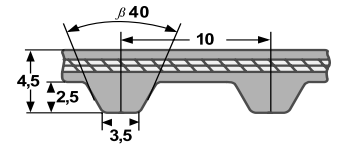

Type T 10 - Teilung/ Pitch 10 mm

Länge length	Breite width	Breite width	Breite width	Breite width	Breite width	Breite width	Breite width
	10 mm Stück/ piece Euro	12 mm Stück/ piece Euro	16 mm Stück/ piece Euro	20 mm Stück/ piece Euro	25 mm Stück/ piece Euro	32 mm Stück/ piece Euro	50 mm Stück/ piece Euro
T10 260	10,20	12,20	15,30	18,40	22,20	27,20	40,70
T10 340	10,20	12,30	15,40	18,60	22,30	27,40	41,10
T10 370	10,30	12,40	15,50	18,70	22,40	27,60	41,30
T10 400	10,40	12,50	15,50	18,80	22,50	27,70	41,60
T10 410	10,50	12,60	15,60	18,90	22,70	27,90	41,90
T10 440	10,60	12,80	15,90	19,20	23,00	28,40	42,60
T10 450	11,00	13,00	16,30	19,70	23,70	29,10	43,60
T10 480	11,20	13,50	16,80	20,20	24,20	29,80	44,60
T10 500	11,50	13,80	17,20	20,60	24,80	30,30	45,60
T10 530	12,10	14,50	17,90	21,60	26,20	32,00	48,00
T10 550	12,30	14,90	18,60	22,30	26,60	32,90	49,40
T10 560	12,50	15,00	18,80	22,50	27,20	33,30	50,30
T10 600	12,90	15,60	19,30	23,40	28,00	34,50	51,70
T10 610	13,00	15,80	19,80	23,80	28,50	35,00	52,50
T10 630	13,60	16,10	20,20	24,30	29,20	36,00	54,30
T10 650	13,80	16,60	20,60	24,80	29,90	36,70	55,40
T10 660	13,90	16,80	21,00	25,10	30,20	37,00	55,70
T10 680	14,20	17,20	21,20	25,60	30,70	37,80	56,70
T10 690	14,50	17,40	21,40	26,10	31,20	38,30	57,60
T10 700	14,60	17,50	21,90	26,30	31,60	38,80	58,00
T10 720	14,90	17,80	22,30	26,70	32,30	39,60	59,00
T10 730	15,10	18,00	22,50	27,20	32,70	40,10	59,40
T10 750	15,30	18,10	22,70	27,40	32,90	40,40	59,90
T10 780	15,50	18,70	23,10	27,90	33,60	41,30	62,60
T10 800	15,80	19,00	23,70	28,50	34,30	42,00	63,40
T10 810	15,90	19,20	23,90	28,90	34,50	42,60	64,00
T10 840	16,40	19,80	24,70	29,70	35,60	43,80	65,80
T10 850	16,60	19,90	24,80	29,90	36,00	44,00	66,00
T10 880	16,80	20,20	25,00	30,20	36,40	44,60	66,60
T10 890	16,90	20,30	25,20	30,30	36,60	45,10	67,20
T10 900	17,10	20,40	25,50	30,70	36,70	45,30	67,70
T10 910	17,20	20,50	25,60	30,80	36,90	45,50	67,80
T10 920	17,30	20,60	25,70	31,00	37,30	45,60	68,40
T10 950	17,60	21,20	26,40	31,80	38,30	46,80	70,90
T10 960	17,80	21,40	26,60	32,00	38,70	47,50	71,30
T10 970	17,90	21,50	26,80	32,50	39,00	48,00	72,10
T10 980	18,10	21,90	27,20	32,70	39,30	48,40	73,10
T10 1000	18,60	22,30	27,70	33,30	40,20	49,20	74,30
T10 1010	18,80	22,50	28,00	33,70	40,70	50,30	75,00
T10 1050	19,00	23,10	29,00	34,80	41,90	51,70	76,60
T10 1080	19,90	23,90	29,80	35,80	43,10	52,90	79,90
T10 1100	20,20	23,90	30,00	36,30	43,50	53,80	80,70
T10 1110	20,20	24,30	30,20	36,40	43,80	54,30	80,80
T10 1140	21,00	25,00	31,10	37,60	45,20	55,70	83,20
T10 1150	21,00	25,20	31,40	37,80	45,50	56,20	84,00
T10 1200	21,40	25,90	32,00	38,60	46,40	57,50	85,70
T10 1210	21,50	26,10	32,60	38,90	47,00	57,60	86,40
T10 1240	22,00	26,30	32,70	39,40	47,50	58,00	87,70
T10 1250	22,20	26,40	32,90	39,80	48,00	58,50	88,60
T10 1300	22,70	27,30	33,90	40,80	49,30	59,90	90,90
T10 1320	23,00	27,70	34,40	41,40	49,90	62,10	91,90
T10 1350	23,40	28,00	34,90	42,00	50,70	62,60	92,70
T10 1390	24,00	28,90	35,80	43,20	52,10	64,00	95,90
T10 1400	24,00	29,00	36,00	43,50	52,10	64,40	96,40
T10 1420	24,40	29,30	36,50	44,00	52,90	65,40	98,20
T10 1440	24,70	29,40	36,70	44,20	52,90	65,40	98,70
T10 1450	24,80	29,80	37,00	44,60	53,90	65,80	99,20
T10 1460	24,90	30,00	37,20	44,90	54,30	66,30	99,50
T10 1500	25,40	30,30	37,90	45,60	55,30	67,20	101,40
T10 1560	25,90	31,00	38,60	46,60	56,20	68,40	103,20
T10 1600	26,40	31,40	39,40	47,40	57,00	70,50	105,80
T10 1610	26,40	31,80	39,50	47,50	57,10	70,80	106,00

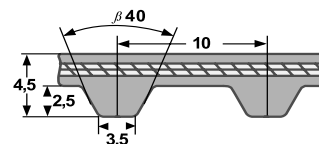

Type T 10 - Teilung/ Pitch 10 mm

Länge length	Breite width	Breite width	Breite width	Breite width	Breite width	Breite width	Breite width
	10 mm Stück/ piece Euro	12 mm Stück/ piece Euro	16 mm Stück/ piece Euro	20 mm Stück/ piece Euro	25 mm Stück/ piece Euro	32 mm Stück/ piece Euro	50 mm Stück/ piece Euro
T10 1700	26,80	32,40	40,10	48,30	57,80	71,30	107,50
T10 1750	27,20	32,60	40,40	48,90	58,50	72,10	108,20
T10 1780	27,60	33,00	41,20	49,90	59,30	73,50	110,00
T10 1800	27,90	33,60	41,80	50,50	60,90	74,40	111,80
T10 1880	29,40	35,30	44,00	52,90	64,00	78,50	117,90
T10 1960	31,30	37,60	46,60	56,20	67,70	83,20	124,70
T10 2250	39,80	48,00	59,00	71,70	86,40	106,00	158,50

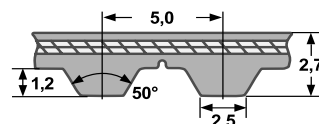

Type AT 5 Teilung/ Pitch 5 mm

Länge length	Breite width	Breite width	Breite width	Breite width	Breite width	Breite width	Breite width
	6 mm Stück/ piece Euro	8 mm Stück/ piece Euro	10 mm Stück/ piece Euro	12 mm Stück/ piece Euro	16 mm Stück/ piece Euro	20 mm Stück/ piece Euro	25 mm Stück/ piece Euro
AT5 225	6,70	8,50	10,10	11,40	14,20	16,70	19,40
AT5 255	7,00	8,90	10,50	11,80	15,00	17,40	20,40
AT5 280	7,30	9,20	11,00	12,40	15,60	18,10	21,30
AT5 300	7,70	9,50	11,40	12,80	16,20	18,80	22,00
AT5 330	7,70	9,90	11,60	13,20	16,60	19,30	22,60
AT5 340	7,70	9,90	11,60	13,20	16,60	19,30	22,60
AT5 375	8,10	10,10	12,10	13,60	17,10	19,90	23,20
AT5 390	8,10	10,20	12,20	13,70	17,30	20,20	23,60
AT5 420	8,40	10,50	12,60	14,20	17,90	20,90	24,40
AT5 450	8,40	10,50	12,60	14,20	17,90	20,90	24,40
AT5 455	8,40	10,50	12,60	14,20	17,90	20,90	24,40
AT5 500	9,10	11,50	13,60	15,30	19,20	22,40	26,20
AT5 545	9,90	12,40	14,70	16,70	20,90	24,40	28,50
AT5 600	10,20	12,80	15,20	17,20	21,50	25,20	29,50
AT5 610	10,30	12,90	15,30	17,40	21,70	25,50	29,80
AT5 630	10,50	13,50	15,80	18,50	22,50	26,50	30,10
AT5 660	10,90	13,90	16,20	18,50	23,10	27,20	31,60
AT5 710	11,10	14,00	16,70	18,80	23,80	27,70	32,40
AT5 720	11,20	14,10	16,90	19,20	24,00	27,90	32,80
AT5 750	11,20	14,10	16,90	19,20	24,00	27,90	32,80
AT5 780	11,40	14,20	17,10	19,20	24,20	28,20	33,00
AT5 825	11,70	15,00	17,60	19,90	25,00	29,40	34,40
AT5 860	11,90	15,20	17,80	20,30	25,50	29,80	34,90
AT5 975	12,50	16,00	18,90	21,30	26,70	31,20	36,50
AT5 1050	13,90	17,60	21,00	23,80	29,70	34,80	40,50
AT5 1125	15,00	18,80	22,50	25,20	31,80	37,20	43,50
AT5 1500	20,20	25,50	30,20	34,30	43,00	50,40	59,00
AT5 2000	26,80	33,90	40,30	45,70	57,40	67,20	78,60

Wickelpreise auf Anfrage.

Prices of sleeves on request.

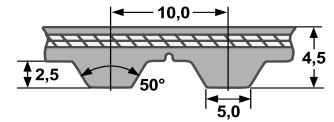

Type AT 10 - Teilung/ Pitch 10 mm

Länge length	Breite width	Breite width	Breite width	Breite width	Breite width
	16 mm Stück/ piece Euro	25 mm Stück/ piece Euro	32 mm Stück/ piece Euro	50 mm Stück/ piece Euro	75 mm Stück/ piece Euro
AT10 500	21,10	30,70	37,70	56,50	84,80
AT10 560	23,10	33,50	41,40	62,20	93,40
AT10 600	24,00	34,70	42,60	64,00	95,90
AT10 610	24,40	35,20	43,50	65,10	97,70
AT10 660	25,90	37,40	45,80	69,30	104,00
AT10 700	26,90	39,00	48,00	71,70	107,60
AT10 730	27,80	40,40	49,50	73,70	110,50
AT10 780	28,60	41,40	51,20	77,30	116,10
AT10 800	29,20	42,10	52,00	78,60	118,10
AT10 840	30,70	44,20	54,40	81,10	121,70
AT10 880	30,90	44,60	55,10	81,90	122,70
AT10 890	31,20	45,10	55,70	82,80	124,10
AT10 920	31,80	45,80	56,50	84,80	127,20
AT10 960	33,00	48,00	58,70	88,10	132,10
AT10 980	33,50	48,80	59,70	90,20	135,20
AT10 1000	34,30	50,00	60,60	92,20	138,30
AT10 1010	34,70	50,40	62,20	92,60	138,90
AT10 1050	35,60	51,70	64,00	94,60	142,10
AT10 1080	36,70	53,30	65,60	99,20	148,70
AT10 1100	37,00	53,70	66,40	99,90	150,00
AT10 1150	38,80	56,50	69,60	103,60	155,60
AT10 1200	39,80	57,80	71,30	106,50	159,80
AT10 1210	40,00	58,10	71,30	106,90	160,40
AT10 1250	40,70	59,40	72,00	109,40	164,00
AT10 1280	41,80	60,60	73,70	111,80	167,70
AT10 1300	41,80	61,00	74,20	112,20	168,50
AT10 1320	42,60	61,90	77,00	113,40	170,20
AT10 1350	43,00	62,70	77,30	114,70	172,10
AT10 1360	43,50	63,10	77,90	115,50	173,40
AT10 1400	44,20	64,30	79,50	119,40	179,00
AT10 1420	45,10	65,60	80,70	121,70	182,50
AT10 1480	46,40	67,60	82,80	125,10	187,70
AT10 1500	46,70	68,40	83,20	125,10	187,70
AT10 1600	48,80	70,90	86,90	129,70	194,70
AT10 1700	49,50	71,70	88,50	133,20	199,90
AT10 1720	50,00	72,60	89,60	134,40	201,60
AT10 1800	51,70	75,00	92,20	139,00	208,60
AT10 1860	54,10	78,20	95,80	144,80	217,30
AT10 1940	56,50	81,60	99,90	150,60	225,90

Wickelpreise auf Anfrage.

Prices of sleeves on request.

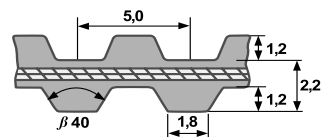

Type DT 5 - Teilung/ Pitch 5 mm

Länge length	Breite width	Breite width	Breite width	Breite width	Breite width	Breite width	Breite width	Breite width
	6 mm Stück/ piece Euro	8 mm Stück/ piece Euro	10 mm Stück/ piece Euro	12 mm Stück/ piece Euro	16 mm Stück/ piece Euro	20 mm Stück/ piece Euro	25 mm Stück/ piece Euro	32 mm Stück/ piece Euro
DT5 300	8,40	10,40	12,20	14,60	18,10	21,20	25,90	31,60
DT5 410	8,40	10,40	12,20	14,60	18,10	21,20	25,90	32,60
DT5 460	8,40	10,60	12,40	14,90	18,60	21,50	26,40	33,00
DT5 480	8,50	10,60	12,50	15,00	18,80	21,60	26,40	33,30
DT5 500	8,90	11,10	13,00	15,60	19,40	22,60	27,70	34,90
DT5 515	9,00	11,50	13,40	16,10	19,90	23,00	28,40	35,50
DT5 550	9,50	11,90	14,00	16,80	21,00	24,30	29,80	37,30
DT5 590	9,50	12,10	14,00	16,90	21,10	24,40	29,90	37,60
DT5 620	9,90	12,30	14,50	17,40	21,50	25,00	30,70	38,50
DT5 650	10,20	12,80	15,10	18,00	22,50	26,10	31,80	40,10
DT5 700	10,40	13,00	15,40	18,60	22,90	26,60	32,70	41,10
DT5 750	10,90	13,60	16,00	19,10	23,90	27,70	33,90	42,60
DT5 800	13,00	16,40	19,30	23,20	28,90	33,60	41,30	51,10
DT5 815	13,40	16,60	19,30	23,70	29,00	33,70	41,30	51,70
DT5 860	13,60	17,10	19,90	23,90	29,80	34,50	42,30	52,90
DT5 900	13,80	17,30	20,20	24,20	30,10	34,90	42,80	53,90
DT5 940	13,80	17,40	20,30	24,40	30,30	35,30	43,20	54,30
DT5 1075	15,10	18,90	22,00	26,60	36,00	38,20	46,40	58,00
DT5 1100	15,40	19,30	22,50	27,20	36,80	39,10	47,50	59,30

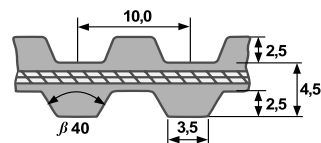

Type DT 10 - Teilung/ Pitch 10 mm

Länge length	Breite width	Breite width	Breite width	Breite width	Breite width	Breite width	Breite width
	10 mm Stück/ piece Euro	12 mm Stück/ piece Euro	16 mm Stück/ piece Euro	20 mm Stück/ piece Euro	25 mm Stück/ piece Euro	32 mm Stück/ piece Euro	50 mm Stück/ piece Euro
DT10 260	14,70	16,60	20,40	24,10	30,20	35,80	53,90
DT10 530	15,90	18,80	23,80	28,60	35,30	43,30	65,00
DT10 600	17,90	21,20	26,80	32,50	39,90	49,00	73,40
DT10 630	18,00	21,40	27,20	32,70	40,10	49,40	74,40
DT10 660	19,30	22,90	29,00	35,00	43,00	52,90	79,70
DT10 700	20,20	23,90	30,20	36,50	44,50	55,20	82,90
DT10 720	20,70	24,40	31,10	37,30	45,80	56,50	88,20
DT10 800	22,30	26,30	33,30	40,20	49,40	61,00	92,60
DT10 840	22,80	26,90	34,20	41,30	50,70	62,30	97,10
DT10 900	24,70	29,00	36,70	44,30	54,30	66,40	104,60
DT10 980	26,20	31,10	39,10	47,10	57,50	71,70	111,30
DT10 1100	28,90	34,10	43,10	51,70	63,80	78,80	122,40
DT10 1210	31,30	37,00	46,70	56,10	69,40	85,50	133,60
DT10 1240	33,20	39,10	49,40	60,50	73,40	90,40	141,50
DT10 1250	36,50	43,00	54,80	65,50	80,60	99,30	154,90
DT10 1320	38,20	45,00	56,50	69,10	84,60	104,60	162,50
DT10 1350	39,10	46,40	57,80	70,30	86,90	106,80	166,00
DT10 1420	40,70	48,10	61,40	73,40	89,90	110,90	173,60
DT10 1500	41,40	49,00	61,90	74,40	91,20	112,60	175,90
DT10 1610	41,80	49,40	62,80	75,30	93,00	114,50	178,00
DT10 1700	42,50	50,30	63,80	76,60	94,00	116,20	181,20
DT10 1800	43,20	50,70	64,50	78,00	95,70	117,50	183,40
DT10 1880	43,70	51,70	65,00	78,80	97,10	119,70	186,10
Wickelpreise auf Anfrage.							
Prices of sleeves on request.							

Polyurethan - Zahnflachriemen/ Meterware - endlich und endlos verschweißt
Polyurethane Timing Belts - open ended and jointed

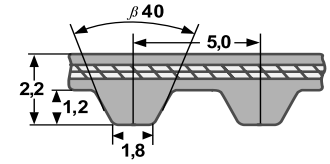

Type T 5 - Teilung/ Pitch 5 mm

	Breite width	Breite width	Breite width	Breite width	Breite width	Breite width
	10 mm	16 mm	25 mm	32 mm	50 mm	100 mm
	Meter Euro	Meter Euro	Meter Euro	Meter Euro	Meter Euro	Meter Euro
Stahlzugträger steel cord	10,10	16,20	24,10	30,80	43,80	87,80
Kevlarzugträger Kevlar cord	11,10	17,80	26,50	33,90	48,20	96,60
Stahl - PAZ steel - PAZ	11,60	18,70	27,80	35,40	50,50	101,00
Kevlar - PAZ Kevlar - PAZ	12,70	20,60	30,40	38,90	55,40	111,20
Stahl - PAZ / PAR steel - PAZ / PAR	13,00	21,10	31,30	40,10	57,00	114,20
Kevlar - PAZ / PAR Kevlar - PAZ / PAR	14,50	23,10	34,40	44,10	62,60	125,70
Verbindung/ Stück joint/ piece	14,10	14,10	20,60	27,20	34,30	54,30
Mindestmenge - V minimum quantity-V Stück/ piece	3	2	1	1	1	1
Mindestlänge - V minimum length - V	L = 700 mm					

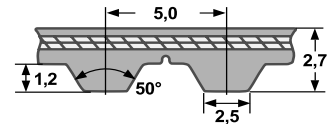

Type AT 5 - Teilung/ Pitch 5 mm

	Breite width	Breite width	Breite width	Breite width	Breite width
	10 mm	16 mm	25 mm	32 mm	50 mm
	Meter Euro	Meter Euro	Meter Euro	Meter Euro	Meter Euro
Stahlzugträger steel cord	13,50	18,80	28,20	35,60	49,30
Stahl - PAZ steel - PAZ	15,40	21,60	32,60	41,10	56,90
Verbindung/ Stück joint/ piece	14,10	14,10	20,60	27,20	34,30
Mindestmenge - V minimum quantity-V Stück/ piece	3	2	1	1	1
Mindestlänge - V minimum length - V	L = 700 mm				

V = Verbindung

Rolle = 50 oder 100 m

Aufpreis für Anschnitte: 10%

V = joint

roll = 50 or 100 m

Surcharge for shorter lengths: 10%

Polyurethan - Zahnflachriemen/ Meterware - endlich und endlos verschweißt
Polyurethane Timing Belts - open ended and jointed

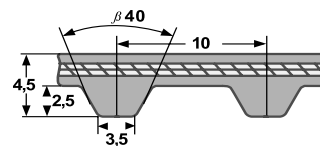

Type T 10 - Teilung/ Pitch 10 mm

	Breite width	Breite width	Breite width	Breite width	Breite width	Breite width	Breite width
	16 mm	25 mm	32 mm	50 mm	75 mm	100 mm	150 mm
	Meter Euro	Meter Euro	Meter Euro	Meter Euro	Meter Euro	Meter Euro	Meter Euro
Stahlzugträger steel cord	16,90	20,30	26,90	33,70	50,90	64,70	97,10
Kevlarzugträger Kevlar cord	18,60	22,30	29,70	37,00	56,10	71,30	106,70
Stahl - PAZ steel - PAZ	19,30	23,20	31,00	38,70	58,70	74,40	111,60
Kevlar - PAZ Kevlar - PAZ	21,40	25,50	34,20	42,60	64,50	81,80	122,90
Stahl - PAZ / PAR steel - PAZ / PAR	21,90	26,20	34,90	43,80	66,40	84,10	126,20
Kevlar - PAZ / PAR Kevlar - PAZ / PAR	24,10	28,90	38,50	48,20	73,00	92,60	138,70
Verbindung/ Stück joint/ piece	14,10	20,60	27,20	34,30	43,70	54,30	82,60
Mindestmenge - V minimum quantity-V Stück/ piece	2	1	1	1	1	1	1
Mindestlänge - V minimum length - V	L = 700 mm						

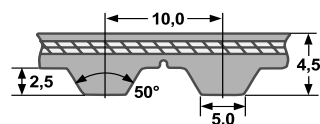

Type AT 10 - Teilung/ Pitch 10 mm

	Breite width	Breite width	Breite width	Breite width	Breite width	Breite width	Breite width
	16 mm	25 mm	32 mm	50 mm	75 mm	100 mm	150 mm
	Meter Euro	Meter Euro	Meter Euro	Meter Euro	Meter Euro	Meter Euro	Meter Euro
Stahlzugträger steel cord	21,60	25,10	32,30	41,20	62,50	80,50	120,80
Stahl - PAZ steel - PAZ	25,00	29,00	37,20	47,30	71,80	92,60	138,90
Verbindung/ Stück joint/ piece	14,10	20,60	27,20	34,30	43,70	54,30	82,60
Mindestmenge - V minimum quantity-V Stück/ piece	2	1	1	1	1	1	1
Mindestlänge - V minimum length - V	L = 700 mm						

V = Verbindung

Rolle = 50 oder 100 m

Aufpreis für Anschnitte: 10%

V = joint

roll = 50 or 100 m

Surcharge for shorter lengths: 10%

ConCar

Polyurethan - Zahnflachriemen/ Meterware - endlich und endlos verschweißt
Polyurethane Timing Belts - open ended and jointed

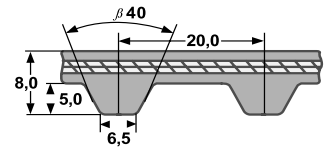

Type T 20 - Teilung/ Pitch 20 mm

	Breite width	Breite width	Breite width	Breite width	Breite width	Breite width
	25 mm	32 mm	50 mm	75 mm	100 mm	150 mm
	Meter Euro	Meter Euro	Meter Euro	Meter Euro	Meter Euro	Meter Euro
Stahlzugträger steel cord	33,30	44,30	60,60	92,60	115,30	181,80
Stahl - PAZ steel - PAZ	38,20	50,90	69,60	106,60	132,70	209,20
Verbindung/ Stück joint/ piece	20,60	27,20	34,30	43,70	54,30	82,60
Mindestmenge - V minimum quantity-V Stück/ piece	1	1	1	1	1	1
Mindestlänge - V minimum length - V	L = 1000 mm					

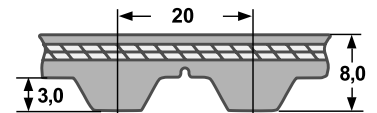

Type AT 20 - Teilung/ Pitch 20 mm

	Breite width mm	Breite width mm	Breite width mm	Breite width mm	Breite width mm	Breite width mm
	25	32	50	75	100	150
	Meter Euro	Meter Euro	Meter Euro	Meter Euro	Meter Euro	Meter Euro
Stahlzugträger steel cord	37,80	48,20	68,90	103,20	137,70	196,60
Stahl - PAZ steel - PAZ	45,70	55,40	79,10	118,60	158,30	226,20
Verbindung/ Stück joint/ piece	20,60	27,20	34,30	43,70	54,30	82,60
Mindestmenge - V minimum quantity-V Stück/ piece	1	1	1	1	1	1
Mindestlänge - V minimum length - V	L = 1000 m					

V = Verbindung

Rolle = 50 oder 100 m

Aufpreis für Anschnitte: 10%

V = joint

roll = 50 or 100 m

Surcharge for shorter lengths: 10%

ConCar

Polyurethan - Zahnflachriemen/ Meterware - endlich und endlos verschweißt
Polyurethane Timing Belts - open ended and jointed

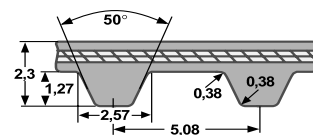

Type XL - Teilung/ Pitch 5,08 mm

	Breite/width	Breite/width	Breite/width	Breite/width	Breite/width
Zoll/ inch	3/8	1/2	3/4	1	2
mm	9,53	12,7	19,05	25,4	50,8
Zoll/ inch	037	050	075	100	200
	Meter	Meter	Meter	Meter	Meter
	Euro	Euro	Euro	Euro	Euro
Stahlzugträger steel cord	12,30	15,30	22,80	29,10	55,30
Stahl - PAZ steel - PAZ	14,10	17,70	26,30	33,50	63,70
Kevlar - PAZ Kevlar - PAZ	15,40	19,40	28,80	36,80	70,00
Verbindung/ Stück joint/ piece	14,10	14,10	20,60	20,60	34,30
Mindestmenge - V minimum quantity-V Stück/ piece	3	2	2	1	1
Mindestlänge - V minimum length - V	L = 701 mm				

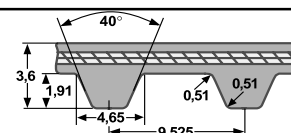

Type L - Teilung/ Pitch 9,525 mm

	Breite/width	Breite/width	Breite/width	Breite/width	Breite/width
Zoll/ inch	1/2	3/4	1	1 1/2	2
mm	12,7	19,05	25,4	38,1	50,8
Zoll/ inch	050	075	100	150	200
	Meter	Meter	Meter	Meter	Meter
	Euro	Euro	Euro	Euro	Euro
Stahlzugträger steel cord	15,30	22,80	29,10	42,30	55,30
Stahl - PAZ steel - PAZ	17,70	26,30	33,50	48,70	63,70
Kevlar - PAZ Kevlar - PAZ	19,40	28,80	36,80	53,60	70,00
Verbindung/ Stück joint/ piece	14,10	20,60	20,60	34,30	34,30
Mindestmenge - V minimum quantity-V Stück/ piece	3	2	1	1	1
Mindestlänge - V minimum length - V	L = 705 mm				

V = Verbindung

Rolle = 50 oder 100 m

Aufpreis für Anschnitte: 10%

V = joint

roll = 50 or 100 m

Surcharge for shorter lengths: 10%

ConCar

Polyurethan - Zahnflachriemen/ Meterware - endlich und endlos verschweißt
Polyurethane Timing Belts - open ended and jointed

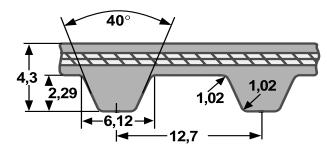

Type H - Teilung/ Pitch 12,7 mm

	Breite/width	Breite/width	Breite/width	Breite/width	Breite/width	Breite/width	Breite/width
Zoll/ inch	3/4	1	1 1/2	2	3	4	6
mm	19,05	25,4	38,1	50,8	76,2	101,6	152,4
Zoll/ inch	075	100	150	200	300	400	600
	Meter Euro	Meter Euro	Meter Euro	Meter Euro	Meter Euro	Meter Euro	Meter Euro
Stahlzugträger steel cord	18,70	20,30	27,20	33,70	50,90	64,70	97,10
Kevlarzugträger Kevlar cord	20,50	22,20	29,90	37,00	56,10	71,30	106,80
Stahl - PAZ steel - PAZ	21,50	23,20	31,30	38,70	58,50	74,40	111,60
Kevlar - PAZ Kevlar - PAZ	23,70	25,50	34,40	42,50	64,50	81,80	122,90
Verbindung/ Stück joint/ piece	20,60	20,60	34,30	34,30	43,70	54,30	82,60
Mindestmenge - V minimum quantity-V Stück/ piece	2	1	1	1	1	1	1
Mindestlänge - V minimum length - V	L = 701 mm						

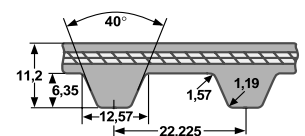

Type XH - Teilung/ Pitch 22,225 mm

	Breite/width	Breite/width	Breite/width	Breite/width
Zoll/ inch	1	2	3	4
mm	25,4	50,8	76	101,6
Zoll/ inch	100	200	300	400
	Meter Euro	Meter Euro	Meter Euro	Meter Euro
Stahlzugträger steel cord	40,10	66,60	100,80	128,10
Stahl - PAZ steel - PAZ	46,10	76,70	116,00	147,30
Verbindung/ Stück joint/ piece	20,60	34,30	43,70	54,30
Mindestmenge - V minimum quantity-V Stück/ piece	1	1	1	1
Mindestlänge - V minimum length - V	L = 705 mm			

V = Verbindung

Rolle = 50 oder 100 m

Aufpreis für Anschnitte: 10%

V = joint

roll = 50 or 100 m

Surcharge for shorter lengths: 10%

ConCar

Polyurethan - Zahnflachriemen/ Meterware - endlich und endlos verschweißt
Polyurethane Timing Belts - open ended and jointed

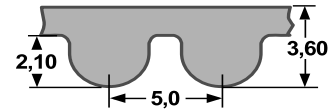

Type 5M - Teilung/ Pitch 5 mm

	Breite width	Breite width	Breite width	Breite width
	10 mm	15 mm	25 mm	30 mm
	Meter Euro	Meter Euro	Meter Euro	Meter Euro
Stahlzugträger steel cord	11,10	15,00	27,30	46,30
Stahl - PAZ steel - PAZ	12,70	17,20	31,40	53,20
Verbindung/ Stück joint/ piece	14,10	14,10	20,60	34,30
Mindestmenge - V minimum quantity-V Stück/ piece	5	3	2	1
Mindestlänge - V minimum length - V	L = 700 mm			

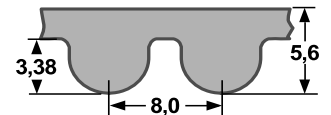

Type 8M - Teilung/ Pitch 8 mm

	Breite width	Breite width	Breite width	Breite width	Breite width	Breite width
	20 mm	25 mm	30 mm	50 mm	85 mm	100 mm
	Meter Euro	Meter Euro	Meter Euro	Meter Euro	Meter Euro	Meter Euro
Stahlzugträger steel cord	22,40	23,40	30,00	38,20	58,10	74,80
Stahl - PAZ steel - PAZ	25,90	26,90	34,50	43,90	66,80	85,70
Verbindung/ Stück joint/ piece	20,60	20,60	27,20	34,30	43,70	54,30
Mindestmenge - V minimum quantity-V Stück/ piece	2	1	1	1	1	1
Mindestlänge - V minimum length - V	L = 704 mm					

V = Verbindung

Rolle = 50 oder 100 m

Aufpreis für Anschnitte: 10%

V = joint

roll = 50 or 100 m

Surcharge for shorter lengths: 10%

ConCar

Polyurethan - Zahnflachriemen/ Meterware - endlich und endlos verschweißt
Polyurethane Timing Belts - open ended and jointed

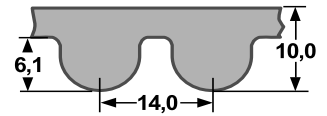

Type 14M - Teilung/ Pitch 14 mm

	Breite width	Breite width	Breite width	Breite width	Breite width	Breite width
	25 mm	40 mm	55 mm	85 mm	100 mm	115 mm
	Meter	Meter	Meter	Meter	Meter	Meter
	Euro	Euro	Euro	Euro	Euro	Euro
Stahlzugträger steel cord	37,20	49,00	67,60	111,30	148,10	185,00
Stahl - PAZ steel - PAZ	42,80	56,30	77,80	128,10	170,40	212,90
Verbindung/ Stück joint/ piece	20,60	34,30	34,30	43,70	54,30	
Mindestmenge - V minimum quantity-V Stück/ piece	4	2	1	1	1	
Mindestlänge - V minimum length - V	L = 700 mm					

V = Verbindung

Rolle = 50 oder 100 m

Aufpreis für Anschnitte: 10%

V = joint

roll = 50 or 100 m

Surcharge for shorter lengths: 10%

Neoprene - Zahnflachriemen/ Meterware - endlich
Neoprene - Timing Belt - open ended

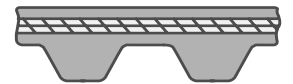

Type XL - Teilung/ Pitch 5,08 mm

	Breite/width	Breite/width	Breite/width	Breite/width	Breite/width
mm	6,4	7,9	9,5	12,7	19,05
Zoll/ inch	025	031	037	050	075
	Meter	Meter	Meter	Meter	Meter
	Euro	Euro	Euro	Euro	Euro
	3,80	4,70	5,50	7,50	11,20

Type L - Teilung/ Pitch 9,525 mm

	Breite/width	Breite/width	Breite/width
mm	12,7	19,05	25,4
Zoll/ inch	050	075	100
	Meter	Meter	Meter
	Euro	Euro	Euro
	7,10	10,60	14,20

Type H - Teilung/ Pitch 12,7 mm

	Breite/width	Breite/width	Breite/width	Breite/width	Breite/width	Breite/width
mm	12,7	19,05	25,4	38,1	50,8	76,2
Zoll/ inch	050	075	100	150	200	300
	Meter	Meter	Meter	Meter	Meter	Meter
	Euro	Euro	Euro	Euro	Euro	Euro
	8,60	12,80	17,20	25,70	34,20	51,30

Neoprene HTD/ RPP - Meterware auf Anfrage.

Aufpreis für Anschnitte: 10%

Neoprene HTD/ RPP open ended on request.

Surcharge for shorter lengths: 10%

**Polyurethan - Zahnflachriemen Flex
mit endlos gefertigten Stahlzugträgern**
**Polyurethane - Timing Belts Flex
with endless steel cord**

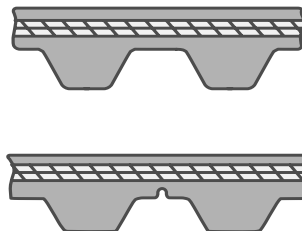

einfach gezahnt/ single toothed

Teilung Pitch	T 5	T 10	T 20	AT 5	AT 10	AT 20	XL	L	H	XH	5M	8M	14M
--------------------------	-----	------	------	------	-------	-------	----	---	---	----	----	----	-----

Länge/ length: 1500 - 22 770 mm Breite/ width: 6 - 150 mm

Preise auf Anfrage. Prices on request.

doppelt gezahnt/ double toothed

Teilung Pitch	DT5	DT10	DT20	DAT5	DAT10	DAT20	DXL	DL	DH	DXH	D5M	D8M	D14M
--------------------------	-----	------	------	------	-------	-------	-----	----	----	-----	-----	-----	------

Länge/ length: 1500 - 22 770 mm Mindestmenge/ minimum quantity: 150 mm

Preise auf Anfrage. Prices on request.

Neoprene - Endlose Hochleistungs - Flachriemen
Neoprene - Endless High Capacity - Flat Belts

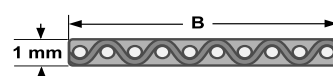

Type 150: h = 1,0 mm

Länge length	Breite width	Breite width	Breite width	Breite width	Breite width	Breite width	Breite width	Breite width	Breite width	Breite width	Breite width	Breite width	Breite width	Breite width
	10 mm	15 mm	20 mm	25 mm	30 mm	35 mm	40 mm	50 mm	60 mm	70 mm	80 mm	90 mm	100 mm	330 mm
	Stück piece	Stück piece	Stück piece	Stück piece	Stück piece	Stück piece	Stück piece	Stück piece	Stück piece	Stück piece	Stück piece	Stück piece	Stück piece	Stück piece
	Euro	Euro	Euro	Euro	Euro	Euro	Euro	Euro	Euro	Euro	Euro	Euro	Euro	Euro
200-600	9,80	12,10	14,10	16,20	18,60	20,80	22,80	28,60	34,20	40,50	44,80	50,30	55,30	165,20
601-700	10,60	12,90	15,40	16,90	20,00	22,40	24,80	30,90	36,90	43,70	48,50	54,40	59,70	179,80
701-800	11,10	14,00	16,20	18,60	21,10	23,80	26,10	32,80	39,30	46,40	51,40	57,60	63,40	190,70
801-900	11,70	14,60	17,20	19,70	22,50	25,00	27,90	34,80	41,70	49,30	54,60	61,30	67,40	202,90
901-1000	12,50	15,50	18,40	21,10	23,90	26,70	29,60	36,90	44,10	52,10	57,70	64,70	71,30	213,80
1001-1200	14,10	17,20	20,40	23,60	26,40	29,90	32,80	41,20	49,30	58,30	64,60	72,50	79,60	239,30
1201-1400	15,60	19,00	22,60	25,90	29,40	32,80	36,20	45,30	54,20	64,00	71,00	79,60	87,50	262,40
1401-1600	16,90	20,80	24,30	28,30	31,90	35,70	39,70	49,70	59,50	70,30	78,20	87,50	96,20	287,90
1601-1800	18,40	22,50	26,40	30,60	34,40	38,80	43,00	53,40	63,90	75,30	84,00	94,00	103,30	309,80
1801-2000	19,70	24,00	28,60	33,00	38,50	41,80	46,40	57,70	69,10	81,80	90,30	101,90	111,90	335,30
2001-2200	21,10	25,90	30,60	35,40	40,20	44,10	49,60	62,20	74,50	87,50	97,60	109,10	119,80	360,80
2201-2400	22,60	27,60	32,70	37,80	42,80	47,90	52,80	66,30	79,60	94,00	104,00	116,20	128,80	385,10
2401-2600	23,90	29,50	34,60	39,90	45,60	50,90	56,40	70,50	84,70	99,80	110,60	123,90	136,00	409,40
2601-2800	25,50	30,80	36,90	42,50	48,10	54,10	59,60	74,50	89,70	105,50	117,00	131,20	144,50	433,60
2801-3000	26,70	32,80	39,00	44,80	50,90	57,10	63,20	75,30	90,30	106,90	122,20	132,40	145,70	437,30
3001-3200	28,30	34,50	41,00	47,30	54,00	60,00	66,20	83,20	99,00	117,70	129,90	145,70	160,30	481,00
3201-3400	29,60	36,40	43,20	49,60	56,50	63,20	69,90	86,90	104,00	123,90	136,00	153,10	167,60	504,10
3401-3600	30,60	38,30	45,20	51,80	59,20	66,10	73,20	91,90	109,80	129,90	143,40	160,30	177,30	530,80

Farbe/ colour: schwarz/ black

Im Längenabstand von 10 mm lieferbar.

Lengths in 10 mm distance available.

Weitere Längen auf Anfrage.

Further lengths on request.

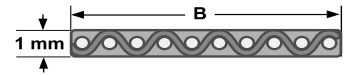

Type P 5110

Länge length	Breite width	Breite width	Breite width	Breite width	Breite width	Breite width	Breite width	Breite width	Breite width	Breite width	Breite width	Breite width	Breite width	Breite width
	10 mm	15 mm	20 mm	25 mm	30 mm	35 mm	40 mm	45 mm	50 mm	60 mm	70 mm	80 mm	90 mm	100 mm
	Stück piece Euro	Stück piece Euro	Stück piece Euro	Stück piece Euro	Stück piece Euro	Stück piece Euro	Stück piece Euro	Stück piece Euro	Stück piece Euro	Stück piece Euro	Stück piece Euro	Stück piece Euro	Stück piece Euro	Stück piece Euro
300-399	9,30	11,70	14,00	16,20	18,50	20,90	23,00	25,40	27,70	32,10	36,80	41,40	45,90	50,60
400-499	9,60	12,00	14,60	16,90	19,50	21,90	24,30	26,70	29,30	34,20	39,20	43,90	48,80	53,80
500-590	9,80	12,50	15,00	17,70	20,20	22,90	25,50	28,00	30,70	35,90	41,20	46,40	51,50	56,70
600-699	10,10	13,00	15,70	18,60	21,20	24,00	26,80	29,50	32,50	37,90	43,50	49,10	54,60	60,30
700-799	10,60	13,30	16,40	19,50	22,90	25,40	28,10	31,40	34,30	40,70	45,90	51,80	57,80	63,70
800-899	10,80	14,00	16,90	20,00	23,20	26,30	29,40	32,60	35,50	41,80	47,90	54,20	60,40	66,50
900-999	11,00	14,50	17,70	20,90	24,10	27,60	29,90	33,30	37,30	43,80	50,40	57,00	63,50	70,00
1000-1099	11,30	14,70	18,10	21,50	24,90	28,30	31,70	34,90	38,40	45,20	51,90	58,80	65,50	72,40
1100-1199	11,70	15,20	18,70	22,40	25,90	29,40	33,00	36,60	40,00	47,20	54,30	61,60	68,50	75,60
1200-1299	12,00	15,70	19,40	23,20	26,70	30,70	34,40	38,00	41,80	49,20	56,70	64,30	71,60	79,20
1300-1399	12,10	16,00	19,90	23,80	27,70	31,60	35,40	39,20	43,20	50,70	58,50	66,20	74,00	81,70
1400-1499	12,50	16,70	20,80	24,70	28,70	32,80	36,80	40,90	44,90	53,10	61,10	69,20	77,50	85,40
1500-1599	12,80	16,90	21,50	25,30	29,40	33,50	37,70	42,20	45,90	54,20	62,40	70,90	79,10	87,40
1600-1699	13,00	17,40	22,20	25,90	30,10	34,40	38,60	43,00	47,20	55,60	64,30	72,80	81,30	89,90
1700-1799	13,20	17,70	23,00	26,70	31,30	35,50	39,90	44,40	48,70	57,80	66,50	75,40	84,30	93,20
1800-1899	13,70	18,40	23,70	27,70	32,30	36,90	41,50	46,30	50,70	60,20	69,20	78,60	87,70	97,10
1900-1999	14,10	18,80	23,90	28,60	33,40	37,90	42,80	47,60	52,40	62,20	71,60	81,30	90,90	100,60
2000-2099	14,20	18,90	24,30	28,80	33,90	38,40	43,50	48,30	53,20	63,00	72,60	82,40	92,20	102,00
2100-2199	14,50	19,40	25,30	30,40	34,40	39,20	44,40	49,10	54,30	64,30	74,10	84,10	94,00	104,00
2200-2299	14,80	19,90	25,30	30,40	35,50	40,60	45,80	50,90	56,30	66,50	76,80	87,10	97,60	107,90
2300-2399	14,90	20,00	23,20	30,70	35,80	40,80	46,30	51,30	56,70	67,30	77,60	88,20	98,60	109,10
2400-2499	15,40	20,80	26,30	31,70	37,00	42,40	47,80	53,20	58,80	69,60	80,40	91,20	102,10	113,10
2500-2599	15,50	21,10	26,80	32,00	37,50	43,20	48,40	54,10	59,60	70,40	81,70	92,80	103,90	114,90
2600-2699	15,70	21,40	27,40	32,60	38,30	44,10	49,70	55,30	61,00	72,30	83,40	94,90	106,10	117,50
2700-2799	16,00	22,10	28,50	33,80	39,40	45,10	51,10	56,70	62,50	74,30	85,90	97,60	109,20	120,70
2800-2899	16,40	22,60	29,10	34,50	40,60	46,60	52,60	58,50	64,50	76,60	88,70	100,70	112,80	124,70
2900-2999	16,80	23,40	29,90	35,30	41,70	47,60	54,00	59,80	65,00	78,60	91,00	103,30	115,80	128,30
3000-3099	17,20	23,60	30,50	36,20	42,50	49,10	55,40	61,70	67,90	80,80	93,30	106,10	118,90	131,60
3100-3199	17,50	24,30	31,10	36,90	43,50	50,10	56,70	63,00	69,70	82,90	95,70	108,80	121,90	134,90
3200-3299	17,90	24,70	31,90	38,00	44,80	51,60	58,40	65,00	71,70	85,10	98,60	112,00	125,60	139,10
3300-3399	18,40	25,40	32,90	39,00	45,80	52,80	59,60	66,50	73,20	87,10	100,80	114,70	128,40	142,20
3400-3499	18,80	26,00	33,50	39,90	47,20	54,20	61,20	68,30	75,30	89,40	103,60	117,70	131,80	146,10
3500-3599	19,40	26,60	34,40	41,00	48,30	55,60	62,60	69,90	77,10	91,60	106,00	120,50	135,00	149,50
3600-3699	19,90	23,20	35,50	42,30	49,80	57,20	64,70	72,30	79,50	94,60	109,50	124,40	139,40	154,30
3700-3799	20,40	28,30	36,50	43,40	51,10	58,80	66,50	74,10	82,10	97,10	112,40	127,70	143,10	158,40
3800-3899	21,10	29,10	37,70	44,80	52,80	60,80	68,50	76,50	84,30	100,20	116,00	131,90	147,80	163,60
3900-3999	21,70	30,00	38,80	46,30	54,40	62,60	70,90	79,00	86,70	103,30	119,80	136,20	152,60	168,90
4000-4099	22,50	30,90	39,90	47,70	56,20	64,70	72,90	81,50	88,80	106,60	123,40	140,20	157,20	174,10
4100-4199	23,00	31,80	41,20	49,10	57,80	66,70	75,10	84,00	91,10	109,80	127,10	144,30	161,90	179,30
4200-4299	23,70	32,80	42,40	50,60	59,40	68,50	77,10	86,50	93,30	113,00	130,80	148,60	166,50	184,50

Standardfarben: gelb oder grau

Standard colours: yellow or grey

Im Längenabstand von 10 mm lieferbar.

Lengths in 10 mm distance available.

Verfügbarkeit auf Anfrage.

Availability on request.

Weitere Qualitäten auf Anfrage.

Further qualities on request.

Werkzeuge zum Endlosschweißen von Polyurethan Keil- und Rundriemen Tools for endless welding of Polyurethane V- and Round-Belt

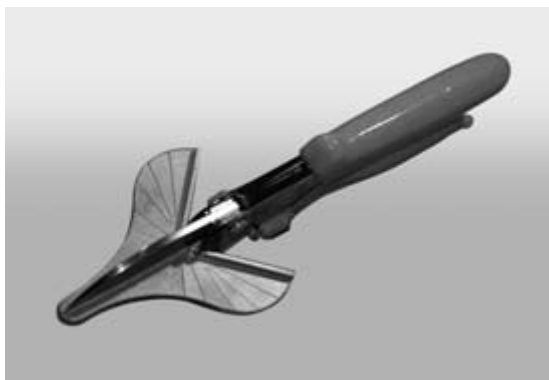

Gehrungsschere GS-25
Cutter GS-25
Euro 56,20



Handbohrer D-11
mit drei Einsätzen, Gr. A, B, C
Drill D-11
includes bits A, B, C
Euro 93,40



Führungszange F-51
auch für Flachriemen bis 50 mm
Pliers F-51
also for flat belts up to 50 mm
Euro 191,00

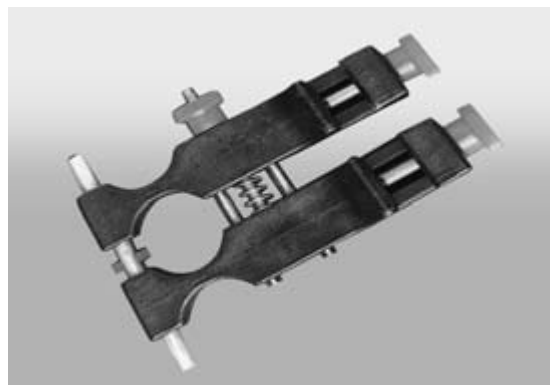

Miniführungszange R-8
für Rundriemen bis 8 mm
Mini pliers R-8
for round belts up to 8 mm
Euro 136,90



Schweißspiegel WU2
Welder WU2
Euro 203,70



Überlappungsverbindungssystem
Preis auf Anfrage.
Overlap splicing system
Price on request.



Durchmesser Diameter mm	RPN grün / green 88 Shore A Meter Euro	RPS* grün / green 88 Shore A Meter Euro	RM rot / red 90 Shore A Meter Euro	RL / RLC*** braun / brown 80 Shore A Meter Euro	ROS* orange 83 Shore A Meter Euro	RO orange 83 Shore A Meter Euro	RMW* beige 95 Shore A Meter Euro	RCW* weiß / white 100 Shore A Meter Euro
2	0,60	–	1,00	1,00	–	–	–	–
3	1,00	–	1,10	1,10	–	1,00	–	–
4	1,20	–	1,20	1,20	–	–	–	–
5	1,50	–	1,50	1,50	–	1,50	–	–
6	2,10	–	–	–	–	–	–	–
6,3	–	–	2,50	2,50	3,30	2,40	3,70	3,70
7	2,80	3,40	–	–	–	–	–	–
8	3,60	4,20	4,00	4,00	4,90	3,80	5,80	–
9	4,70	6,30	–	–	–	–	–	–
9,5	–	–	5,40	5,40	6,50	5,00	7,70	7,20
10	5,50	7,00	–	–	–	–	–	–
12	7,20	9,80	–	–	–	–	–	–
12,5	–	–	9,00	9,00	11,10	8,50	13,00	13,00
14	–	–	–	–	14,00	11,00	–	–
15	10,30	15,30	12,90	12,90	16,00	12,20	18,80	–
18	17,20	–	19,80	19,80	–	–	28,80	–
19	–	–	–	–	24,60	18,70	–	–
20	20,20	–	21,10	–	–	–	–	–

Profil Section	VM rot / red 90 Shore A Meter Euro	VL braun / brown 80 Shore A Meter Euro	VH gelb yellow 100 Shore A Meter Euro	VMW*/ ** beige 95 Shore A Meter Euro	VLW* blau / blue 80 Shore A Meter Euro	VO orange 83 Shore A Meter Euro	VM/ VL VH/ VO Supergrip Meter Euro	VMW/ VLW Supergrip Meter Euro
V- 8/M	4,30	4,30	4,30	–	–	4,30	15,40	–
V-10/Z	4,90	4,90	4,90	6,60	–	4,90	16,30	18,00
V-13/A	6,70	6,70	6,70	8,90	8,90	6,70	18,50	20,70
V-17/B	10,00	10,00	10,00	11,70	11,70	10,00	22,60	24,40
V -20	13,00	13,00	13,00	–	–	13,00	26,50	33,60
V-22/C	16,20	16,20	16,20	19,70	20,10	16,20	30,40	34,10
V-25	21,90	21,90	21,90	–	26,10	21,90	36,90	37,20
V-32/D	33,50	33,50	33,50	–	39,60	33,50	57,60	59,30
V-40/E	53,30	53,30	53,30	–	–	53,30	91,40	101,50

Profil Section	VL-RT braun / brown 80 Shore A Meter Euro	VM-RT rot / red 90 Shore A Meter Euro	VLW-RT* blau / blue 80 Shore A Meter Euro	YMF beige 100 Shore A Meter Euro
A/13	11,10	11,10	–	–
B/17	16,40	16,40	25,40	16,40
C/22	28,50	28,50	34,80	28,50

Technische Einzelheiten siehe Seite 87.

Technical details see page 87.

Profil Section	DVOS* orange 83 Shore A Meter Euro	VOS-GT* orange 83 Shore A Meter Euro	VOS* orange 83 Shore A Meter Euro	DVL 80 Shore A Meter Euro	DVO 83 Shore A Meter Euro	DVM 90 Shore A Meter Euro
10	–	–	–	12,50	12,60	–
A/13	22,90	–	8,80	17,30	17,30	17,30
B/17	–	11,80	11,60	–	–	–
C/22	–	19,20	–	–	–	–
D/32	–	39,90	–	–	–	–



Durchmesser Diameter	Hohlrundriemen Hollow Round Belts	Nippel Nipples	
mm	rot / red ' 85 Shore A Meter Euro		
4,8	2,60	1,00	Weitere Typen auf Anfrage. Further types on request.
6,3	3,00	1,00	
8	4,00	1,00	
9,5	5,40	1,20	
12,5	8,00	1,20	
15	11,00	1,30	
16	11,80	1,50	

* zugträgerverstärkt/ reinforced with cord

* reinforced with cord





























** ab Profil 13/ A gezahnt

** from section 13/ A toothed











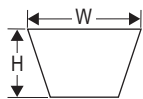













*** transparent











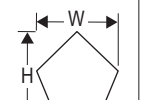



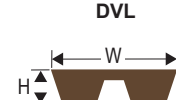



*** clear

Rundriemen 2 mm	Rolle = 60 m
Rundriemen RCW	Rolle = 150 m
alle anderen	Rolle = 30 m
round belt 2 mm	roll = 60 m
round belt RCW	roll = 150 m
all others	roll = 30 m

	RL / RLC***	RLW	RO	ROS	RPN	RPS	RM	RMW	RCW										
																			
Härte/Hardness Temperatur/Friction Stahl/Steel FDA/USDA	80 SHORE A -40°C bis/to 55°C 0.55 Ja/Yes	80 SHORE A -40°C bis/to 55°C 0.55 Ja/Yes	83 SHORE A -40°C bis/to 55°C 0.55 Ja/Yes	83 SHORE A -40°C bis/to 55°C 0.55 Ja/Yes	88 SHORE A -30°C bis/to 80°C 0.38 Nein/No	88 SHORE A -30°C bis/to 80°C 0.40 Nein/No	90 SHORE A -30°C bis/to 60°C 0.45 Ja/Yes	95 SHORE A -30°C bis/to 60°C 0.36 Ja/Yes	100 SHORE A -20°C bis/to 75°C 0.27 Ja/Yes										
Durchmesser (mm) Diameter (mm)	  1%	  0.5%	  1%	  0.5%	  1%	  1%	  1%	  1%	  1%										
2	15	0.06			19	0.13		20	0.26										
3	20	0.14		18	0.17			29	0.31			30	0.60						
4	30	0.25						38	0.54			40	1.00						
5	35	0.40		30	0.38			48	0.85			50	1.60						
6								57	1.22										
6,3	40	0.60		38	0.68	42	4.5					60	2.60	75	20	100	25		
7								67	1.67	70	18								
8	55	1.00		48	1.06	54	5	76	2.18	80	19	80	4.20	95	35				
9								86	2.75	90	21								
9,5	65	1.40		57	1.54	64	9.5					95	5.90	110	37	150	40		
10								95	3.40	100	22								
12								114	4.90	120	26								
12,5	85	2.50	90	18	75	2.75	86	11.4				125	10.10	150	57	200	42		
14							95	12.3											
15	100	3.50			95	4.25	108	13.6	143	7.65	150	27	150	14.60	175	60			
18	120	5.10	125	27					171	11.00	180	37	180	21.00	210	64			
19					115	6.11	127	15											
20									190	13.60			200	25.90					

* – VERFÜGBAR MIT SUPER GRIP / AVAILABLE WITH SUPER GRIP

	VL*	VLW*	VO*	VOS	VOS-GT	VM*	VMW*	VH*										
																		
Härte/Hardness Temperatur/Friction Stahl/Steel FDA/USDA	80 SHORE A -40°C bis/to 55°C 0.55 Ja/Yes	80 SHORE A -40°C bis/to 55°C 0.55 Ja/Yes	83 SHORE A -40°C bis/to 55°C 0.55 Ja/Yes	83 SHORE A -40°C bis/to 55°C 0.55 Ja/Yes	83 SHORE A -40°C bis/to 55°C 0.55 Ja/Yes	90 SHORE A -30°C bis/to 60°C 0.45 Ja/Yes	90 SHORE A -30°C bis/to 60°C 0.36 Ja/Yes	100 SHORE A -20°C bis/to 75°C 0.28 Ja/Yes										
Größe B x H (mm) Size W x H (mm)	  1%	  0.5%	  1%	  0.5%	  0.5%	  1%	  1%	  1%										
8/M = 8 x 6.2	40	0.7		45	0.9	40	5		60	3.0				125	4.8			
10/Z = 10 x 6.5	45	1.0							65	4.1	75	25	130	6.6				
13/A = 13 x 8	50	1.6	50	12	50	1.6	53	12		80	6.7	65	28	160	10.7			
17/B = 17 x 11.5	75	2.9	75	18	75	2.9	72	17	75	17	115	12.1	100	55	230	19.5		
20 = 20 x 12.5	85	3.9			75	2.6					125	15.9			250	25.5		
22/C = 22 x 14.5	100	4.8	100	22	100	4.6			100	19.5	145	20.0	150	72	290	32.0		
25 = 25 x 16.5	110	6.3			100	4.6					165	25.9			330	41.5		
32/D = 32 x 21.5	145	10.4	145	43					145	25	215	43.0						

	VL-RT	VM-RT	VLW-RT	YMF	DVL	DVO												
																		
Härte/Hardness Temperatur/Friction Stahl/Steel FDA/USDA	80 SHORE A -40°C bis/to 55°C 0.55 Ja/Yes	90 SHORE A -30°C bis/to 60°C 0.45 Ja/Yes	80 SHORE A -40°C bis/to 55°C 0.55 Ja/Yes	90 SHORE A -30°C bis/to 60°C 0.45 Nein/No	80 SHORE A -40°C bis/to 55°C 0.55 Ja/Yes	83 SHORE A -40°C bis/to 55°C 0.55 Ja/Yes												
Größe B x H (mm) Size W x H (mm)	  1%	  1%	Größe B x H (mm) Size W x H (mm)	  0.5%	Größe B x H (mm) Size W x H (mm)	  1%	Größe B x H (mm) Size W x H (mm)	  1%	  1%									
10/Z			Z/10				Z/24 (9.5) x 6.8	45	2.0	45	2.0							
13/A = 13 x 16	110	2.7	160	11.0	A/13 = 13 x 16	110	16	A/13 = 13 x 15	150	10.0								
17/B = 17 x 19.5	130	4.3	195	17.8	B/17 = 17 x 19.5	130	19	B/17 = 17 x 8.5	185	14.1								
22/C = 22 x 28.5	190	7.9	285	32.5	C/22 = 22 x 24.5	165	38	C/22 = 22 x 24.5	250	28.9								



auf Anfrage
on request

ConCar

INDUSTRIETECHNIK GMBH

Am Königholz 6
D-85411 Hohenkammer
Tel.: +49 (0) 81 66 / 99 17-0
Fax: +49 (0) 81 66 / 99 17-30
E-Mail: info@concar.de
Internet: www.concar.de

